

APERIODIC H.F. AMPLIFICATION

The Wireless World

AND
RADIO REVIEW

4^D

The Paper for Every Wireless Amateur

Wednesday, July 2nd, 1930.

POWER SUPPLY UNITS

for all Portables & for all other Radio Receivers!

Cut your running costs in half

EKCO

No Batteries. Accumulators always on full charge.

Write for Free Booklet on "All-Electric Radio," and details of Easy Payments to E. K. Cole Ltd., Dept. W. "Ekco" Works, Leigh-on-Sea.

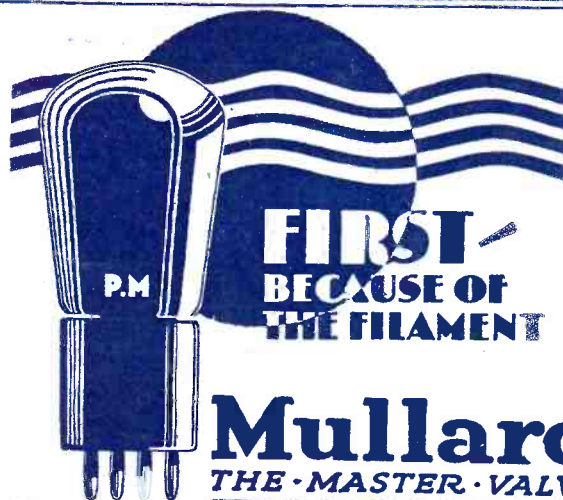

**FIRST-
BECAUSE OF
THE FILAMENT**

Mullard
THE MASTER VALVE

Condenser ruptured—

Sorry tale—

HYDRA next time—

Cannot fail!

LOUIS HOLZMAN, 37, NEWMAN ST., LONDON, W.1. Telephone: Museum 2641.

A BETTER UNIT 66P

27/6



Your High and Low Wave-Lengths controlled by a Single Knob

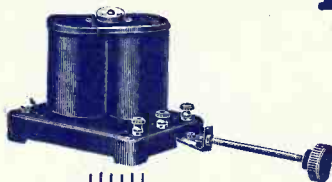

Lewcos Dual Binocular Coils. The Lewcos Dual Range Binocular Coils have wave-length ranges of 235-550 m. and 1,000-2,000 m., the wavelength range being selected by a simple push-pull switch which protrudes through the receiver panel.

Ref. D.B.A. Price 17s. 6d. each.

Ref. D.B.G. Price 17s. 6d. each.

Ref. D.B.P. Price 17s. 6d. each.

THE LEWCOS H.F. CHOKE

gives efficient performance on all wavelengths from 2,000 down to 20 metres.

Size $1\frac{1}{2}'' \times 2\frac{1}{2}'' \times 3\frac{3}{8}''$ high.

Price . . . 7s. 9d. each.

TESTED VALVES
Self Capacity, 1·62
Micro - microfarads
(N.P.L. Test).

Natural Wavelength,
5,200 metres.
(Tested with Moull
in Voltmeter.)



THE LONDON ELECTRIC WIRE COMPANY AND SMITHS LTD.,
Church Road, Leyton, London, E.10.

Stocks held at Belfast, Dublin, Leeds, Cardiff, Glasgow, Liverpool, Manchester,
Newcastle, London.

D·C to A·C

If your supply mains are D.C. you can operate an A.C. All-Electric Receiver by using the



Can be supplied to run from any voltage 12-250 V.D.C. 40 watt model £13; 85 watt model £19. Recommended and used by Philips Radio, Marconiphone, Burndept, Kolster-Brandes, M.P.A., Etc., Etc.

Write for Pamphlet 596/1 which gives full details.

THE M-L MAGNETO SYND. LTD.,
Radio Dept., COVENTRY.

Telephon. 5001.

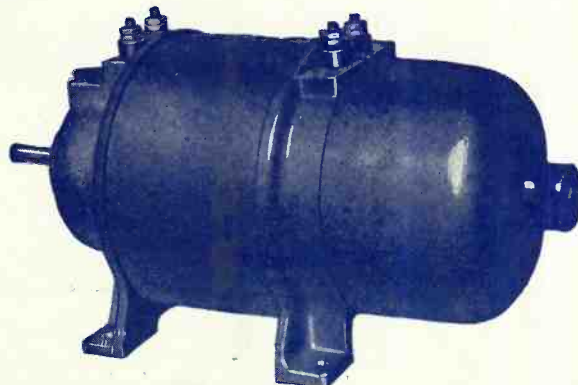

Mention of "The Wireless World," when writing to advertisers, will ensure prompt attention.

DO NOT COMPROMISE WITH QUALITY

We warn manufacturers to study carefully their source of supply of paper condensers. The world has only a few reliable makers of paper condensers, who will really supply a condenser that will last years and years. In fact, they can be counted on the fingers of one hand.

This advertisement is for the attention of manufacturers primarily, also the general public, and is intended to point out that the prices of reliable paper condensers have reached the bottom. Also, before buying paper condensers that are much cheaper—one should remember that the basic cost of first-grade raw material imposes a limit on the minimum selling price and below a certain figure reliability cannot be expected.

Therefore :—

- (a) Manufacturers purchasing these *apparently* cheap condensers run a big risk of damaging their reputation in the long run (unless they want to be in business only while the boom is on, and we are not anxious to have such customers), and might, even though remotely, risk the life of the ultimate customer.
- (b) The public risk the burning out of the complete instrument, and perhaps worse.

Make certain that your condensers are made by a reputable house—for absolute safety buy Hydra—they have not compromised with quality since their inception in business 32 years ago.

LOUIS HOLZMAN, LTD.

37, Newman St., W.1.

Telephone : Museum 2641.

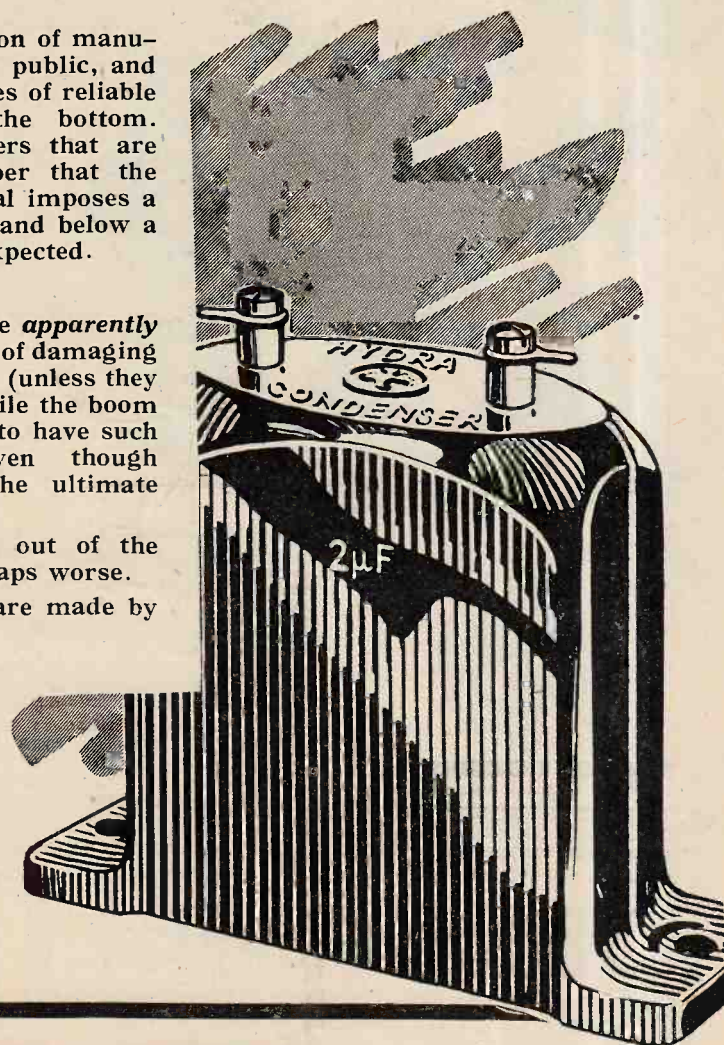

HYDRA

Darwin COBALT STEEL

Unrivalled for all
WIRELESS & ELECTRICAL Purposes.

*Write to Magnet Dept.
for Latest Booklet.*

DARWINS LIMITED, Fitzwilliam Works, SHEFFIELD.
London Office: 80, Bishopsgate, E.C.2.

Magnets.

PARFAIT

THE PERFECT
EBONITE PANEL
ONE QUALITY ONLY
THE BEST

SUPPLIED IN SIX FINISHES | Matt Cube Surface | Semi-Polished Mahogany | Highly Polished Black | Highly Polished Black.
Stocked by most Wireless dealers. If any difficulty in obtaining locally write for name of nearest stockist to:
H. B. POTTER & Co., Ltd., Station Buildings, ROCHDALE.



The J.B. "Tiny" Condenser combines precision and expert craftsmanship with many ingenious features of design—all in an area little more than that of a match box. Extreme neatness and lightness make "Tiny" particularly useful for Portables. The Slow-Motion mechanism is housed in the bottom bearing, and therefore occupies no extra space. Two nickel-plated brass end plates ensure absolute rigidity and accuracy.

Ball Bearings, Pigtail Connection and thorough insulation are naturally found in the J.B. Condenser. Complete with knob, pointer and scale, and fitted with slow motion, ratio 8-1.

Prices:

'0005	..	10/-	'0003	..	9/6
'0002	..	9/-	'0001	..	8/6

PRECISION INSTRUMENTS

Advertisement of Jackson Bros., 72, St. Thomas' Street, London, S.E.1.

Telephone: Hop 1837.

Make Use of The Wireless AND RADIO REVIEW World DEPOSIT DEPARTMENT

A recent user writes:

"Please accept my thanks for the services rendered in the purchase of the eliminator which I have decided to keep. You can therefore forward the money to the seller with my thanks.

"I shall always praise your Deposit System which is the safest way of dealing with strangers that I know of."

W. H. THEWLIS,
49, Webster Street,
OLDHAM, Lancashire.

Full particulars of "The Wireless World" Deposit System are given on the first page of Miscellaneous Advertisements.

W.W.94.

The Yachting World and Motor Boating Journal

The Leading British Yachting Journal

"THE YACHTING WORLD" deals with yachts and boats of all types and tonnages, whether on the sea or inland waters. Every aspect of yachting and motor boating is covered in an attractive and interesting manner.

Every Friday 6D.

ILIFFE & SONS Ltd., Dorset House, Tudor St., London, E.C.4

W.W. 81

DICTIONARY of WIRELESS TECHNICAL TERMS

(1926)

Compiled by S. O. Pearson, B.Sc.

Issued in conjunction with "THE WIRELESS WORLD."

THIS volume contains concise definitions of terms and expressions commonly used in wireless telephony and telegraphy, and serves as a guide to all those interested in wireless who come across, from time to time, unfamiliar words in their reading. Well illustrated and cross-referenced.

Price 2/- net. By post 2/2.

From leading booksellers or direct from

ILIFFE & SONS LTD.,

W.W.48. Dorset House, Tudor Street, London, E.C.4.

Mention of "The Wireless World," when writing to advertisers, will ensure prompt attention.

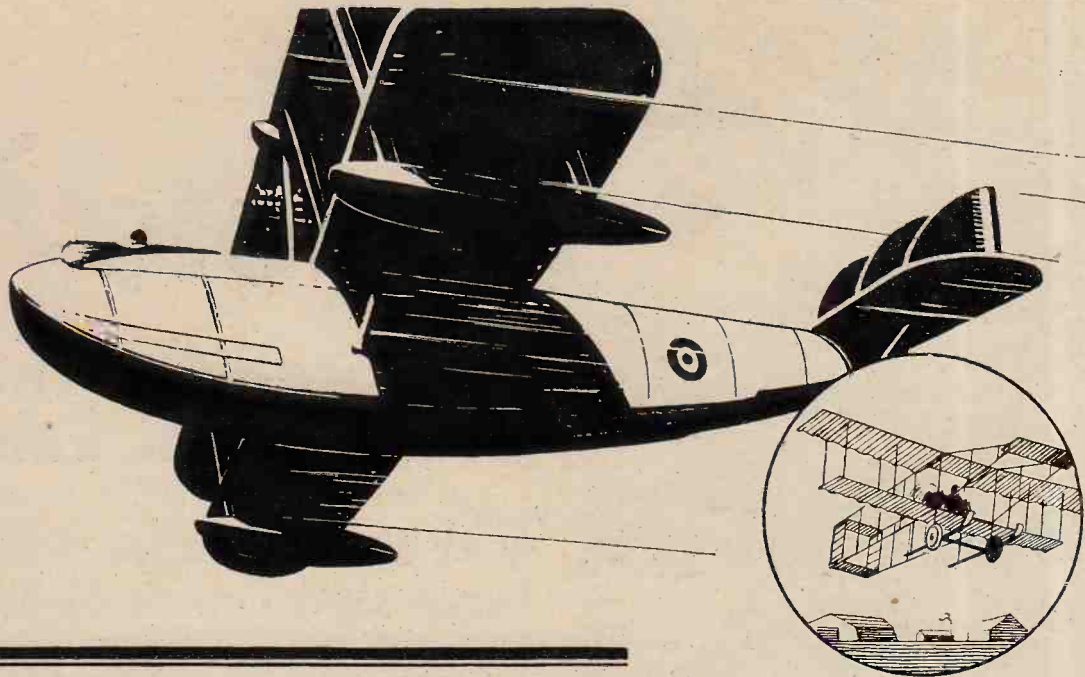

PROGRESS

60%
LONGER LIFE
**What
a life!**



There is just as much difference between a Pertrix Battery and the ordinary sal-ammoniac battery as there is between a modern air liner and the first aeroplane that ever flew.

The Pertrix is one of the greatest achievements in wireless. It has an amazingly long life—in many cases as much as 80% longer. And the reason is that the Pertrix contains

NO SAL-AMMONIAC

It never becomes corroded as do ordinary sal-ammoniac batteries, and you are able to obtain clear, pure reception until every atom of power has been used.

You can also obtain Pertrix batteries for your flash lamp. Write for leaflet "B," which will give you full particulars of all types.

PRICES.								
STANDARD.			DISCHARGE 12 MILLIAMPS.		GRID BIAS.			
Volts.	Size in inches.			s.	d.	Volts.	s.	d.
	L.	B.	H.					
60	5 ⁵ / ₁₆	6 ¹ / ₄	3 ¹ / ₁₆	8	0	9	1	6
100	8 ¹ / ₂	6 ¹ / ₄	3 ¹ / ₁₆	13	0	12	2	3
120	10 ³ / ₈	6 ¹ / ₄	3 ¹ / ₁₆	15	6	15	2	9

PERTRIX

PATENT
DRY BATTERY

PERTRIX, LTD., Britannia House, 233, Shaftesbury Avenue, London, W.C.2

M.C.108

Engine Trouble!

**He's telling them
with Marconi Valves**

**In Air Liners—on the Sea—wherever
Human safety depends on Radio—
Marconi Valves are used ★**



★
**Tell your customers this
when selling them Valves**

MARCONI VALVES

The All-British Valves with the All-Better Performance!

The Wireless World

AND
RADIO REVIEW
(18th Year of Publication)

No. 566.

WEDNESDAY, JULY 2ND, 1935.

VOL. XXVII. No. 1.

Editor: HUGH S. POCOCK.

Assistant Editor: F. H. HAYNES.

Editorial Offices: 116-117, FLEET STREET, LONDON, E.C.4
Editorial Telephone: City 9472 (5 lines).

Advertising and Publishing Offices:

DORSET HOUSE, TUDOR STREET, LONDON, E.C.4.
Telephone: City 2847 (13 lines). Telegrams: "Ethaworld, Fleet, London."

COVENTRY: Hertford Street.

Telegrams: "Cyclist, Coventry." Telephone: 5210 Coventry.

BIRMINGHAM: Guildhall Buildings, Navigation Street.

Telegrams: "Autopress, Birmingham." Telephone: 2970 and 2971 Midland.

MANCHESTER: 260, Deansgate.

Telegrams: "Liffe, Manchester." Telephone: 8970 City (4 lines).

GLASGOW: 101, St. Vincent Street, C.2.

Telegrams: "Ildie, Glasgow." Telephone: Central 4857.

PUBLISHED WEEKLY.

Subscription Rates: Home, £1 1s. 8d.; Canada, £1 1s. 8d.;
other countries abroad, £1 3s. 10d. per annum.

Entered as Second Class Matter at New York, N.Y.

As many of the circuits and apparatus described in these pages are covered by patents, readers are advised, before making use of them, to satisfy themselves that they would not be infringing patents.

CONTENTS OF THIS ISSUE.

	PAGE
EDITORIAL VIEWS	1
APERIODIC H.F. AMPLIFICATION. BY A. L. M. SOWERBY	2
INSULATORS TESTED. I. EBONITE	7
THE BAND PASS FOUR (CONCLUDED). BY W. T. COCKING	10
CURRENT TOPICS	14
A NEW A.C. SCREEN-GRID VALVE	16
LOGGING THE SOUTHERN CROSS	20
WIRELESS THEORY SIMPLIFIED. PART XXXV. BY S. O. PEARSON	22
BROADCAST BREVITIES	25
CORRESPONDENCE	26
READERS' PROBLEMS	27

SOUND INTENSITY AT THE RECEIVER.

HOW often it may happen that a well-known voice broadcasting from the studio is unrecognisable when reproduced in the home by means of the loud speaker. This may occur even when we know that conditions both at the receiver and the transmitter are such as to ensure undistorted reproduction. When this effect is observed we will find that it is the strength of reproduction which is responsible for disguising the voice, for nothing destroys the personal quality of a voice more than departure from the normal strength of reproduction, especially if the reproduction is too loud.

If the B.B.C. broadcasts a voice which is naturally soft it should be so reproduced at the receiving end and not boosted up until the speaker's quiet, confidential manner of talking, which may be the secret of his personal charm, comes to us resembling a Hyde Park platform oration.

But if we do not know the speaker so that we can adjust our receivers to what we know to be his normal

speaking voice, we have nothing to go upon, and only luck will decide whether or not in our homes we are retaining the character of the speaker's voice. Perhaps the B.B.C. can devise some solution of the difficulty—just as the makers of gramophone records tell us the speed at which the record should be played, so, perhaps, the B.B.C. could devise some code whereby they could tell listeners at what reproduction strength to set their receivers in order to repeat the conditions at the microphone as regards sound intensity.

We have on previous occasions stressed the desirability of the B.B.C. maintaining as far as possible an unvarying degree of modulation at the transmitter, so that our receivers can remain set to any one station without the necessity, which at present exists, for readjusting volume at the receiver at frequent intervals during an evening's programme because of the varying control exercised at the transmitter during the performance of different items.

If some simple means of giving the listener a comparative standard of sound intensity could be devised, a partial solution to this problem might be found. A crude suggestion would be that from time to time the B.B.C. should transmit notes of standard intensity so calibrated that note 1, when just audible in the receiver, would indicate the correct receiver setting for studio talks; note 2, when just audible, would indicate the best setting for a chamber music concert; and so on, the B.B.C. indicating the code against items on their printed programmes, or making announcements in advance of the items.

o o o o

WIRELESS ON THE "SOUTHERN CROSS."

PROBABLY at no time in the history of wireless on aircraft has there been a better opportunity of demonstrating its importance than on the occasion of the recent transatlantic flight of the "Southern Cross," piloted by Major Kingsford Smith.

In this issue we are able to publish an interesting account of how the progress of the flight could be followed by amateurs who, under the organisation of the Radio Society of Great Britain, listened-in on short-wave receiving apparatus in this country. There have been several instances in the past to indicate the necessity for every long-distance plane to be equipped with wireless of some kind, but this latest experience will probably serve to emphasise the importance of wireless equipment, not merely as a means of establishing communication, but also for the purpose of ascertaining the bearings of the aeroplane by means of wireless direction finding.

APERIODIC H. F. AMPLIFICATION

Making the Most of the
Choke-coupled Amplifier.

By

A. L. M. SOWERBY, M.Sc.

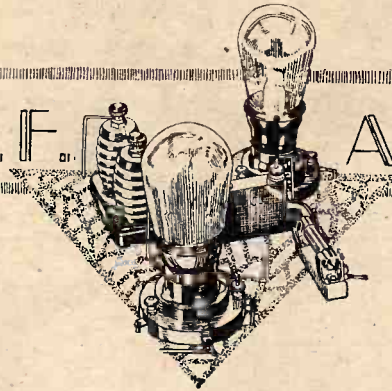

AN article entitled "Receiving Sets of To-day," published in *The Wireless World* in November last, gave a comprehensive review of the extent to which various alternative types of coupling had been adopted in the commercial sets on the market at that date. One of the interesting oddments of information included in the review was to the effect that 44 per cent. of the amplification carried out at high frequency by the listeners of Britain is achieved with the aid of untuned couplings of one kind or another.

It would undoubtedly be a pity if 44 per cent. of the space devoted in this journal to the problems of high-frequency amplification were expended in discussions of this simple, but remarkably inefficient, type of amplifier; but, without going so far as to grant full proportional representation, it is only fair to concede that its wide use entitles it to a little space occasionally. The writer recently had occasion to look

into some of the problems which arise in trying to use a choke-coupled amplifier for reception on the 200-600-metre band of wavelengths, and managed, with the aid of some measurements, to evolve one or two inaccurate, but usable, generalisations from the primordial chaos of his original conceptions.

The bulk of the measurements made were directed to the elucidation of the choke-coupled amplifier in its most usual form, in which an ordinary triode with a 0.1-ampere filament is used as the amplifying valve. Moreover, for reasons that will be

The circuit used was that of Fig. 1, which will be recognised as typical of the aperiodic stage as used in most portable receivers; a "Lewcos" high-frequency choke was used throughout as being fairly representative of the better class of such components.

Before proceeding to recount the results of the measurements made it will be well to survey the field a little in order to acquire a general idea of the nature of the problems that arise. For amplification to be at all effective with the simple arrangement of Fig. 1 it is necessary that the high-frequency choke should have an impedance at least equal to, and preferably considerably in excess of, that of the valve in whose plate circuit it is to be connected. To see how far this desirable state of affairs can be attained, let us turn our attention

to Fig. 2, which shows the circuit of Fig. 1 simplified down to the barest possible skeleton.

In this E represents the voltage developed within the valve itself in response to the signal voltage applied to its grid. R_0 is the internal resistance of the valve, while Z represents the total impedance, to high-frequency currents, of every possible path leading from the anode of the valve either direct to its filament or to "H.T. +", which is connected back to the filament through a condenser of negligibly low impedance. The voltage E will drive a current round this circuit, and the current will, in turn, set up a voltage across each of the obstructions R_0 and Z . The sum of these potential differences will always be E ; their relative magnitudes will depend entirely upon the relative values of R_0 and Z , the larger potential difference being set up across whichever impedance is the larger of the two. If Z is large compared

AN analysis of the circuits used in portable sets of to-day shows that choke-coupled aperiodic H.F. amplification is still popular. In the accompanying article the actual stage gain with various valves is measured and the interesting conclusion reached that with triodes the anode-grid capacity causes sufficient reverse reaction effect to reduce the input to a small fraction of its original value. It is only by virtue of incidental and deliberate reaction that such a stage amplifies at all. Use of the screen-grid valve affords a partial solution of the problem.

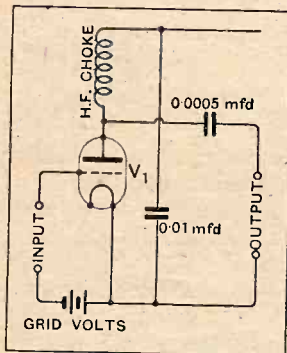

Fig. 1.—Basic circuit of the choke-coupled stage used for experiments. A whole series of valves, mostly of the "610" class, was used at V_1 , while various components and measuring instruments were connected to the "Input" and "Output" terminals for the experiments made.

mentioned later, no measurements were made on the band of wavelengths round about 1,600 metres.

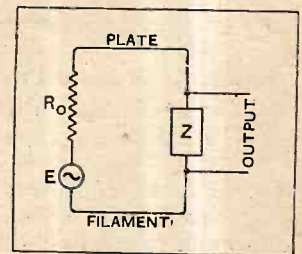

Fig. 2.—This circuit is a simplification of Fig. 1. E is the voltage generated within V_1 , R_0 its internal resistance, and Z the total impedance of everything in its anode circuit.

Aperiodic H.F. Amplification.—

with R_0 the voltage across it will not fall far short of E , but if Z is small only a small fraction of E will appear across it. Since the output terminals are across Z , the success of the amplifier depends entirely on our ability to make Z large.

In order to see how to do this we must go back to Fig. 1 and see what paths there are along which high-frequency currents can travel between the plate of V_1 and earth. The only possible path, according to Fig. 1, is through the choke, but there are also a number of other minor paths through

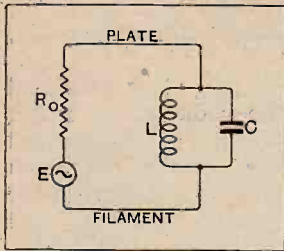

Fig. 3.—This repeats Fig. 2, showing the two parts L and C , into which the total impedance of the plate circuit can be divided. It is particularly to be noticed that L and C do not form a tuned circuit, so far at least as the wavelengths considered are concerned.

the "stray" capacities existing between earth on the one hand and the anode, and points connected to it, on the other. Thus Z , of Fig. 2, resolves itself into two paths in parallel, as in Fig. 3, where L stands for the inductance of the choke and C for the total of stray capacities. In an average case the inductance of the choke will be of the order of 100,000 microhenrys; at a wavelength of 600 metres the impedance corresponding to this is about 300,000

ohms, rising to 900,000 ohms at 200 metres. The value of the stray capacities it is less easy to assess; if we assume that under working conditions the sum total of these will amount to some 25 micro-microfarads (0.000025 mfd.) we are not likely to be in error by more than one or two hundred per cent. either way. The impedance of the "C-branch" in Fig. 3 would, at this estimate, amount to about 12,000 ohms at 600 metres, dropping to some 4,000 ohms at 200 metres.

Importance of Capacity of H.F. Choke.

Comparing the two branches, it is evident that the stray capacities will carry practically all the high-frequency current that is flowing in the anode circuit of the valve. The current flowing through the choke is so small that we shall be justified in ignoring it completely, and in regarding C as the sole component connected between the plate of the valve and earth. This, of course, from the point of view of signals only; the valve would hardly work at its best with no D.C. connection to the H.T. battery, so that the removal of the choke is a purely "theoretical" operation, and unfortunately impossible.

Seeing that the equivalent impedance in the anode circuit of a choke-coupled high-frequency stage is so low we can only expect a small gain per stage. If a low-impedance valve is chosen the stage-gain will be quite a good fraction of the amplification factor of the valve. If a valve of higher impedance is chosen the stage-gain will be a smaller fraction of the amplification factor of the valve, but the amplification factor itself will be larger, which may compensate us for having to accept a smaller fraction of it. A continuous raising of the valve resistance thus gives us a stage-gain which

is a steadily decreasing fraction of the steadily rising " μ " of the valve.

Somewhere in this process there is going to be an optimum point, a certain value of amplification factor giving a stage-gain greater than can be obtained with a valve of either higher or lower resistance. It becomes desirable, then, to obtain some idea of the best valve to choose as choke amplifier, and, owing to the very uncertain value of the stray capacities, this information has to be acquired by measurement rather than by calculation.

Measurements were accordingly made, a known high-frequency voltage being applied to the terminals labelled "Input" in Fig. 1, while a valve voltmeter was connected to the "Output" terminals to read the magnitude of the high-frequency voltage developed at this point. The ratio of output to input voltage is, of course, the stage-gain. These experiments were carried out at 200, 300, and 500 metres, using valves of the modern Marconi or Osram "610" series in turn. Each valve was given an anode voltage of about 100 volts, with a grid bias of $1\frac{1}{2}$ volts.

Effect of Amplification Factor and Grid Bias.

The results are given, in graphical form, in Fig. 4, in which the stage-gain measured is plotted against the amplification factor of the valve. Each curve refers to a different wavelength. It will be observed that, as suggested, each curve shows an ill-defined maximum point that corresponds to the most profitable figure under the conditions of measurement. This best value

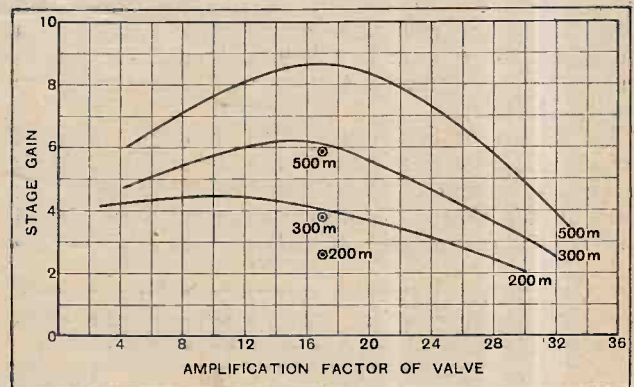

Fig. 4.—Stage-gain for valves of different amplification factor. Curves refer to Marconi and Osram 610 series; points (1) refer to obsolete valve of lesser efficiency ($\mu=17$, $R_0=19,000$ ohms). For each wavelength there is a "best value" of amplification factor, above and below which the stage-gain falls off.

of amplification factor is not the same for all wavelengths, varying from 17 at 500 metres to about 10 at 200 metres.

It will be understood, of course, that in making such a series of measurements as these it is necessary to keep throughout to valves of similar design if the results obtained are to be at all intelligible. For comparison, an obsolete valve, which has an amplification factor of 17 in conjunction with an A.C. resistance of 19,000 ohms, was also tried. The results found are marked in as separate points in Fig. 4, and show up very clearly

Aperiodic H.F. Amplification.—

that the lower resistance of modern valves is reflected in a handsome increase in amplification.

For all the measurements summarised in the curves of Fig. 4 the operating voltages were the same for all valves. It is known, however, that the A.C. resistance of a valve is dependent to a very large extent upon

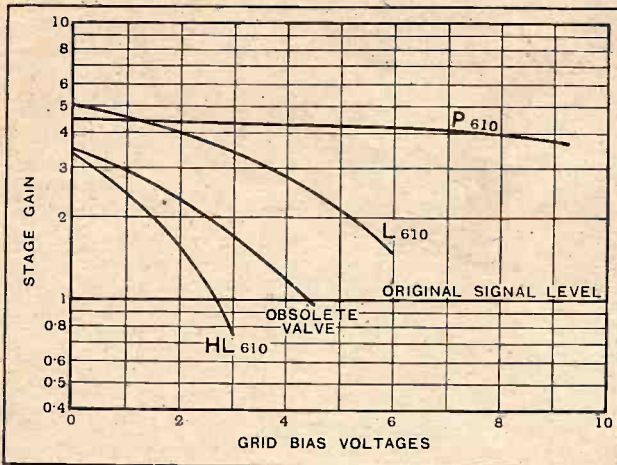

Fig. 5.—Variation of amplification with grid bias voltage at 200 metres.

the voltages applied to its grid and plate, while the three points off the curves (referring to the obsolete valve) show very clearly that the stage-gain attained with choke-coupling is very largely dependent on the A.C. resistance. It was, therefore, considered worth while to make a fresh series of measurements, on each valve, keeping the anode voltage constant at 120 volts and varying the grid voltage over as wide a range as was practicable.

The results of this investigation into the effects of varying the operating voltages are given in the curves of Figs. 5, 6, and 7, which show up very clearly that the grid bias applied has a very profound effect indeed upon the amplification attained by the stage. The

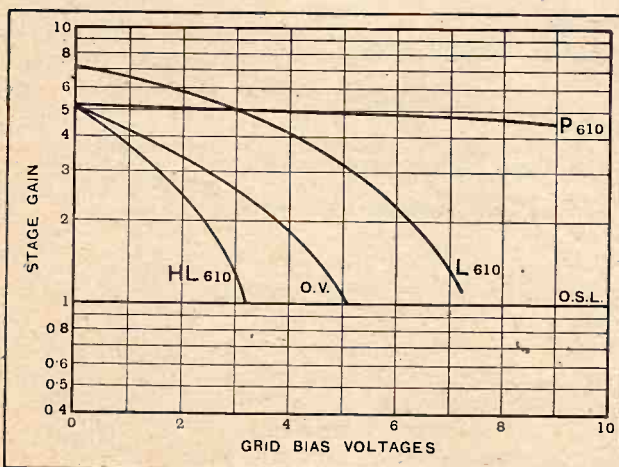

Fig. 6.—Variation of amplification with grid bias voltage at 300 metres. The obsolete valve is represented by O.V. and original signal level by O.S.L.

valves of higher amplification factor are seen to be the most sensitive to changes in grid bias, the curves for the H.L.610 valve ($\mu=30$) being particularly steep. At 200 metres, with -3 volts on the grid, this valve amplifies only 0.7 times; which means, more bluntly put, that it hands on to the next valve 30 per cent. less signal voltage than it receives.

Provided that the grid bias applied is kept quite small, the best valve of the series, at all wavelengths, is the D.E.L.610. With $4\frac{1}{2}$ volts of negative bias the D.E.P.610 is more effective, the D.E.L.610 improving by comparison as the wavelength is increased, and catching it up in efficiency at 500 metres, after which, though there are no measurements to prove the point, the D.E.L.610 will take the lead.

All this is very muddling, and the results presented so far may even have made it seem more difficult, rather than easier, to select the right valve for a choke-coupled amplifier. In the receivers (mostly portables) in which choke-amplification is used the greatest stumbling-block in the path of the designer is usually the very rigid limitation of plate current. It therefore seemed reasonable to measure the amplification afforded by the

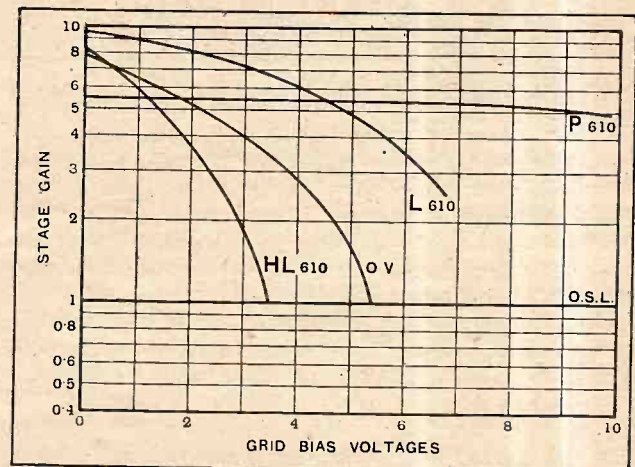

Fig. 7.—Variation of amplification with change of grid bias voltage at 500 metres.

different valves when worked under such conditions that their anode current was the same. If there is one milliamp. available for the choke-coupled stage, one may then pick out the valve that will give the greatest amplification in return for this current. It is by no means certain that it will be the same valve that has so far come out of the ordeal by measurement with the greatest credit.

Figs. 8, 9 and 10 show the amplification to be had from a single choke-coupled stage with each valve examined (an H.610 was added to the list for these measurements). Each diagram refers throughout to a single value of anode current. It will at once be noticed that at any anode current from $\frac{1}{2}$ mA. to 2 mA. the best valve of the series is the H.L.610, with an amplification factor of 30 and a nominal A.C. resistance of 30,000 ohms. If one milliampere is available, the amplification afforded by this valve runs from 2.2 times

Aperiodic H.F. Amplification.—

at 200 metres up to 5.5 times at 500 metres. With 2 mA. the stage-gain is higher (see Fig. 10).

It must be pointed out at this stage that the actual figures for amplification and even, to some extent, the order of merit of the different valves, will depend to a large extent on the stray capacities in the circuit. For the measurements quoted here, an attempt was made to

tions at which the amplification factor and A.C. resistance of the valve are officially measured. At this anode current the amplification attained was found to be 2.79, 4.25, and 7.06 at 200, 300 and 500 metres respectively. Assuming the maker's figures for the valve, this leads to 38, 37½ and 37 micromicrofarads respectively as the result of three entirely independent measurements of the stray capacity. This figure may therefore be taken as representative of the capacity likely to be encountered in the interstage coupling of an amplifier of this general type.

It will have been gathered by now that it is entirely the stray capacity that limits the effectiveness of aperiodic amplification; no improvements that we can make in the coupling choke, for example, will so much as touch the fringe of the problem. The choke, in fact, except in so far as it provides one source of stray capacity, is the only component in a choke-coupled amplifier that has no bearing whatever on the results obtained. Careful choice of valve holders is much more likely to improve the efficiency of the stage than any care bestowed on the selection of a choke. The latter

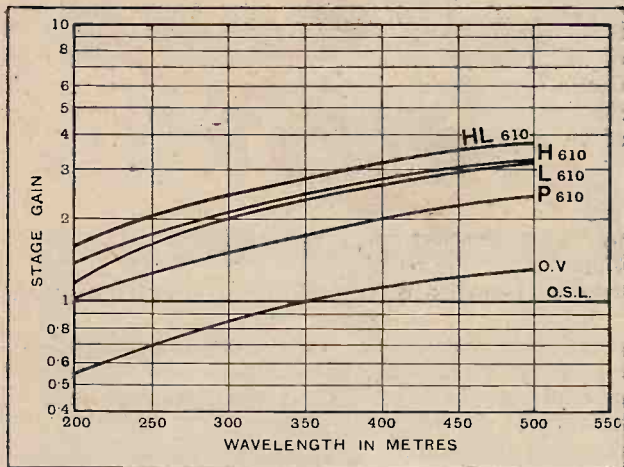

Fig. 8.—Stage-gain at various wavelengths with different valves. The anode current was 0.5 mA. in all cases.

arrange that the stray capacities should have a value about as low as they could be got in a practical receiver without decapping either the amplifying valve itself or the one into which its output is fed. No attempt was made to measure directly the capacity between plate and earth, because this would only give the static capacity, which may be quite widely different from the working capacity with the valves actually alight and amplifying. A rough approximation to the effective capacity can, however, be made by simple calculation from the amplification attained. Reference to the Marconi catalogue shows that the H.L.610 valve takes 1½ mA. at 100 volts on the plate and zero grid bias, these being the condi-

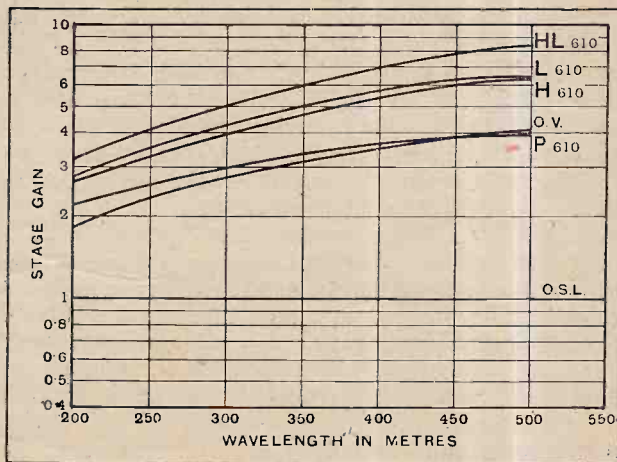

Fig. 10.—Stage-gain at different wavelengths with various valves. The anode current was 2 mA. in all cases.

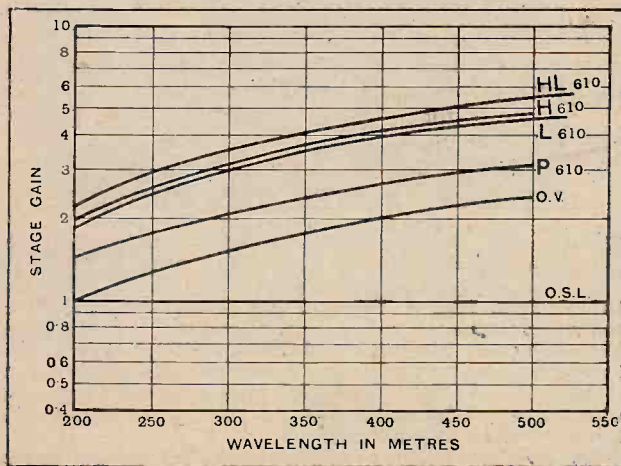

Fig. 9.—Stage-gain at different wavelengths with various valves. The anode current was 1 mA. in all cases.

might, in fact, be replaced by a resistance without making the slightest difference to results, except that a higher anode battery voltage would be required to give the same anode current, on the value of which, as we have seen, the stage-gain is considerably dependent. Since the resistance need not have a value much greater than 10,000 ohms, the voltage dropped in it would not be excessive at the plate currents generally used; an extra thirty volts, at most, would suffice.

It is only by a whole-hearted attack on the stray capacities that any great improvement in results can be anticipated; by decapping the valves between which the choke (or resistance) is situated a considerable increase in amplification might be expected to ensue. This idea has already been carried to the extremest limit that is commercially possible in the Loewe multiple valve, where two valves, with their associated couplings, are built into a single bulb. It is probable that this method, or some extension or development of it, will

Aperiodic H.F. Amplification.—

provide eventually the best solution of aperiodic amplification on the broadcast wavelengths.

Earlier in this article it was stated that aperiodic amplification on the longer broadcasting band would not be considered here in any detail. The reason for this apparently arbitrary decision is that on these wavelengths the choke-coupled amplifier begins to partake of the character of an amplifier coupled by flatly tuned circuits. The impedance offered by the inductance of the choke drops, and that offered by the stray capacity rises as the wavelength is increased, until at the longer waves the two are approaching equality. The behaviour of the amplifier then becomes dependent to a very considerable extent upon the characteristics of the individual chokes used, and though the amplifier offers

a much greater stage-gain, and so becomes a much more "worth-while" proposition, it is a much less suitable subject for discussion along general lines. Experimental results tend no longer to apply to choke amplifiers as a class, but only to the individual collection of components used for the measurements made.

The experiments and measurements quoted so far were all made under such conditions that the input to the valve was held constant whatever load the amplifying valve might impose upon its grid circuit. Since it is known that any amplifying valve, the plate circuit of which is predominately capacitative, loads its grid circuit very considerably (negative reaction) it was considered worth while to make some slight investigation of the magnitude of this effect.

(To be concluded.)

THE INTERPRETATION OF RESPONSE CURVES.

Does the Frequency-response Curve only give a Partial Indication of Performance?

IN the investigation of apparatus such as loud speakers or gramophone pick-ups it is customary to take response curves as an indication of the performance. Increasing use of such curves is being made in the technical and popular Press, both in illustrating technical articles and in advertising matter. It seems desirable, therefore, to consider the exact nature of a response curve and determine how far a curve gives an indication of the performance of the device in question.

It is the purpose of this short note to show that a response curve of a loud speaker or gramophone pick-up gives only a partial indication of the performance. A well-known method of taking the response curve of a loud speaker is to supply the speaker with a constant input over the normal frequency range, a beat oscillator being used for the purpose. The sound from the speaker is picked up by a capacity microphone, the output of which is measured by a valve voltmeter. The voltmeter readings are, therefore, an indication of the frequency response of the speaker. In practice it is usual to measure the output voltage at a number of frequencies, from which a curve is then plotted.

Identical Response Curves but Different Audible Results.

Experiment shows that two different types of speaker may have almost identical curves derived in this manner and yet the audible result is very different. This appears to be due to the fact that the curve does not give any indication of one of the most important factors which determine the performance of the speaker.

If we consider any mechanical system capable of being set into vibration, it takes a certain time period for the amplitude of the vibration to reach a maximum, and a certain period for the vibration to cease after the exciting force is removed. This is determined in practice by the existing electrical and mechanical conditions of the loud speaker moving element and its associated diaphragm. For ease of reference we may consider this as a function of the mechanical decrement of the moving system.

Supposing that the speaker is energised at a given frequency for a certain time T , the diaphragm ought obviously to vibrate for exactly the same period. In practice it will probably vibrate for a time T_1 . The more nearly T and T_1 are equal the more faithful should be the response, and probably the ratio T/T_1 could be considered as a measure of the property so-called "attack."

Now it follows that when a response curve is taken by the method previously mentioned, this factor does not influence the curve at all. The speaker is constantly energised for a long period during which the output is measured. It is, therefore, obvious that a speaker might have a very large T/T_1 ratio on all frequencies, but the output would still be given as constant, which, of course, is quite true. A simpler way of considering the question is to say that the speaker is slightly resonant to an equal extent over the frequency range investigated. Only when the resonances become unequal at various frequencies does the curve begin to show peaks and troughs.

It follows from this reasoning that a loud speaker response curve simply serves to indicate the cut-off at each end of the scale and the position of marked resonance peaks. It can only give a partial indication of the practical performance of the speaker.

P. D. T.

o o o o

ELECTRIC POWER DISTRIBUTION.

THE East England Electricity Scheme—which had not been authorised by the Central Electricity Board at the time we published the particulars of the "National Grid" in our issue of February 19th—has now been approved and will comprise two main generating stations, at South Denes, Yarmouth, and Thorpe, Norwich, respectively, with a main transforming station at King's Lynn and a secondary station at Bury St. Edmunds. Provision is made for inter-connection with the generating stations at Peterborough and Ipswich in the South-East England area.

The existing generating station at King's Lynn will also be employed, pending the necessary enlargement of the two selected stations at Yarmouth and Norwich.

**The first . . .
INDIRECTLY
HEATED
PENTODE**

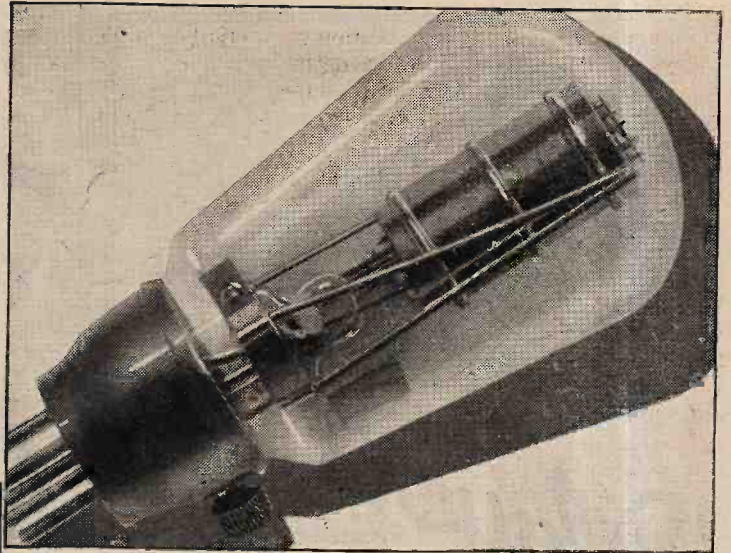

**EDISWAN
LEADS
AGAIN
WITH THE
MAZDA
AC/PEN**

THIS new power output valve marks an important step in the history of Radio. The indirectly heated Cathode absolutely prevents hum, and the AC/Pen is the most sensitive pentode in existence.

With a grid swing of only ten volts it will give wonderful results when used with a good cone speaker, and is ideal for operating a moving coil speaker such as the R.K.

PRICE 30/-

The Amazing

**MAZDA
RADIO
VALVES**

CHARACTERISTICS

Filament volts	4.0
Filament amps (approx.)	1.0
Anode volts (max.)	250
Auxiliary Grid Volts (max.)	200
Mutual A.C. conductance (mA/V)	2.2



THE EDISON SWAN ELECTRIC CO., LTD.

Radio Division,

1a Newman Street, Oxford Street, W.

Showrooms in all the Principal Towns

V.56

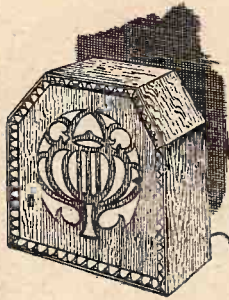

Everybody's
calling for

*Player's
Please*



THE BEST — REGARDLESS!

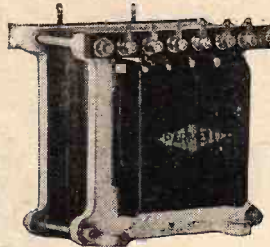

Write for Price List
of Wireless Mains
Apparatus.

Our motto, which you see above, means that the Diamond trade mark of PARMEKO appears on only the finest apparatus you can buy. It is our boast that PARMEKO components are fit for laboratory use. The best designers, the best workmen, the best machinery, and the best materials enable them to pass the stringent tests to which they are submitted before they are allowed to leave the factory, backed by our guarantee of perfection. There is a PARMEKO Transformer and Choke for every circuit featured in the technical press —and we make to specification.

PARMEKO

PARTRIDGE & MEE LIMITED

26 Dover Street,
LEICESTER
CENT. 22276.

74 New Oxford Street,
LONDON, W.C.1
Museum 5070.

WIRELESS

DIRECTION FINDING and DIRECTIONAL RECEPTION

(1927)

By R. KEEN, B.Eng. (Hons.).

Second Edition: Revised and Enlarged.

THIS volume deals with the principles of the subject and the constructional details of direction-finding installations, and includes some information concerning aircraft installation. It describes the principles of Direction and Position Finding in this country in such a way that the subject may be grasped easily by engineers tackling this field of wireless work for the first time. Numerous photographs and diagrams are included.

Price 21/- net. By post 21/9

*From leading booksellers or
direct from the Publishers:*

LILFFE & SONS LIMITED,
Corset House, Tudor Street, London, E.C.4.

RADIO DATA CHARTS

A SERIES OF ABACS

providing most of the essential
Data required in Receiver Design

By R. T. BEATTY, M.A., B.E., D.Sc.

"Radio Data Charts" provide designers of wireless apparatus with a ready and convenient means of solving problems without having recourse to complicated formulae and mathematics.

By the use of the charts it is possible to tackle all the more familiar problems in radio receiver design; including, for example, finding the relationship between inductance capacity and frequency, and working out the design of high frequency transformers. All keen amateurs will appreciate this helpful book.

Price 4/6 net. By post 4/10.

From all leading booksellers or direct from the publishers.

Published from the Offices of
"THE WIRELESS WORLD,"

Dorset House, Tudor Street, London, E.C.4.
W.W.93

INSULATORS
TESTED

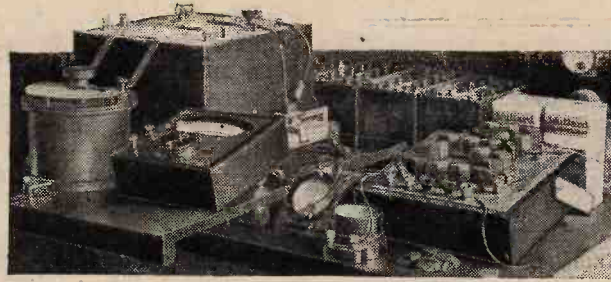

[1]
EBONITE

THIS article on the dielectric and physical properties of ebonite is the first of a series giving full technical details of the various insulators used in radio apparatus. As a guide to low-loss design the data given should prove invaluable. The merit of each insulator is measured as a power-loss factor which is the product of power factor and permittivity, the latter term being better known as specific inductive capacity or dielectric constant.

The General Purpose Insulator.

By W. H. F. GRIFFITHS, F.Inst.P., A.M.I.E.E.

IN a recent article¹ in this journal the author dealt with the various factors which contribute to the total loss of power in an insulator which is subjected to an alternating electric field. It was shown that at the lower (speech) frequencies surface leakage was the cause of appreciable loss of power in addition to that lost due to dielectric hysteresis in the body of the insulating material. At radio-frequencies, however, especially at the higher radio-frequencies, the loss of power is almost always due entirely to the latter cause, and, it will be remembered, a measure of this loss is the product of the power factor and permittivity of the material, the product being termed the power-loss factor. The significance of this quantity as regards low-loss design was explained.

It is now proposed to give a series of short articles describing briefly the properties of the more important insulating materials. These articles should serve as a guide to the selection of insulating materials for the construction of radio apparatus in general, and low-loss components in particular.

Ebonite is the best-known and most useful general purpose insulating material, and is, for this reason, the first to be described in this series of articles.

The process of the vulcanisation of rubber by the

addition of sulphur and the subsequent subjection to heat was first discovered about the middle of the last century, but various other "fillers" were included in the material, which was, in consequence, really a "loaded" ebonite. These filling materials were gradually omitted until finally a "pure" ebonite of only rubber and sulphur was obtained.

Ebonites in which new rubber and sulphur are the only constituents are much better electrically than those in which fillers are embodied to "load" the material and so to harden it and to increase its mechanical strength. The various grades of pure ebonite usually vary less in dielectric quality than those which are variously loaded, and, although there are a few makes of the latter which are quite good,² these should not be employed in low-loss design unless some definite knowledge of power factor is available. In this article it is intended only to deal with pure (unloaded) ebonite.

As a general purpose insulator ebonite is practically unrivalled, except where great mechanical strength is required or where there is a risk of softening due to its subjection to tropical temperatures. For indoor use in temperate climates it is capable of maintaining a very high degree of surface

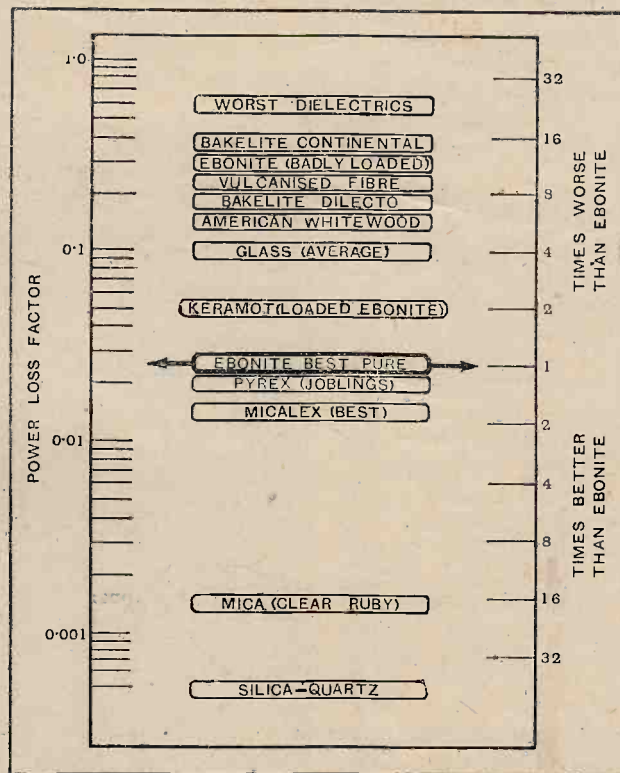

Fig. 1.—Chart of insulating materials showing relative power-loss factor.

¹ See "Dielectric Properties of Insulators," *The Wireless World*, April 16th, 1930.

² Especially that known as "Keramot," which will be described in the next of the series.

Insulators Tested—(1) Ebonite.—

insulation, and is, for this reason, invariably used for high-grade direct-current testing apparatus. For such purposes, where surface leakage is to be kept down to a minimum, the surfaces of an ebonite insulator must be kept clean and dry. For this reason it is advised that the exposed surfaces of apparatus to be used in dusty or humid atmospheres should be highly polished. Ebonite is very easily polished if its surfaces are first made quite smooth with fine emery paper.

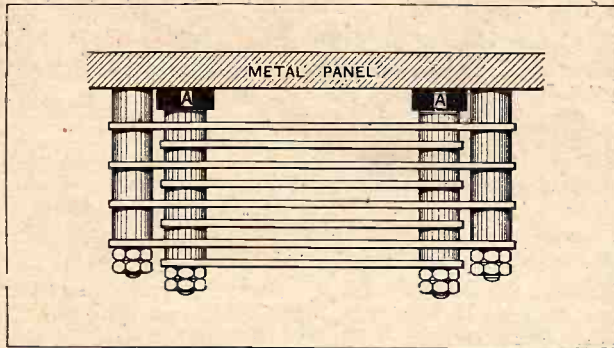

Fig. 2.—Method of supporting the plates in an air-dielectric condenser.

When employed in apparatus which is intended for use at speech frequencies the same precautions are sometimes necessary, but in radio-frequency apparatus it is rarely necessary to consider surface leakage except as a criterion of very dirty surfaces which may lead to dielectric loss.

Equivalent Series Resistance.

From a power loss point of view, in alternating-current work, especially at radio-frequencies, ebonite is not an insulator of *outstanding* quality (as it is for D.C. work), as will at once be appreciated by reference to Fig. 1, in which a number of insulating materials are charted in order of power-loss factor. It will be seen that ebonite with a power-loss factor of 0.025 (at medium to high radio-frequencies) is an approximate mean between the very good and very bad materials, and for this reason it is the material against which other insulators should, for convenience, be compared. The chart is constructed on a logarithmic basis so that a material can be readily compared with those of both better and inferior quality; for instance, ebonite and glass appear in the chart at exactly the same distance below and above Keramot, because they are respectively twice as good and twice as bad as the latter material.

Although fifty times better than some of the worst insulating materials, ebonite is fifty times worse than the best low-loss insulator known, fused silica or Vitreosil, and so, for low-loss design, care must be taken to avoid its use in excessive quantities, especially in apparatus for circuits of low total capacity.

To many readers, no doubt, the loss of an inductance or condenser, or of a circuit comprising these components, could be better expressed in terms of equivalent resistance. It is, therefore, proposed to consider the

equivalent resistance-producing effect of the introduction of a certain proportion of ebonite into the electric field of a pure-air condenser as would be the case, for instance, in the insulators AA of one bank of plates of the condenser shown in Fig. 2. If the total capacity of this condenser is 250 micro-microfarads, and the capacity due to electric field *through the insulators* is 10 micro-microfarads, then if these insulators are of best-quality pure ebonite the equivalent resistance of the condenser will be 0.2 ohm at a wavelength of 300 metres. The change of equivalent resistance of this condenser which would result from the substitution of insulators of similar dimensions but of various other insulating materials will be given when those materials are described later in the series.

Frequency Affects Power-loss Factor.

In good ebonites the power factor and permittivity, and therefore the power-loss factor, do not vary very greatly with different supplies, but the variation of these quantities with frequency is sometimes considerable. The power-loss factor invariably gradually increases with frequency until it is about 50 per cent. greater at 10^6 cycles per second than at 1,000 cycles per second, although in some of the most perfect specimens this increase may be as much as 100 per cent.

The popularity of ebonite as a general purpose insulator is no doubt increased by the fact that it is easily worked, although it tends somewhat to blunt tools.

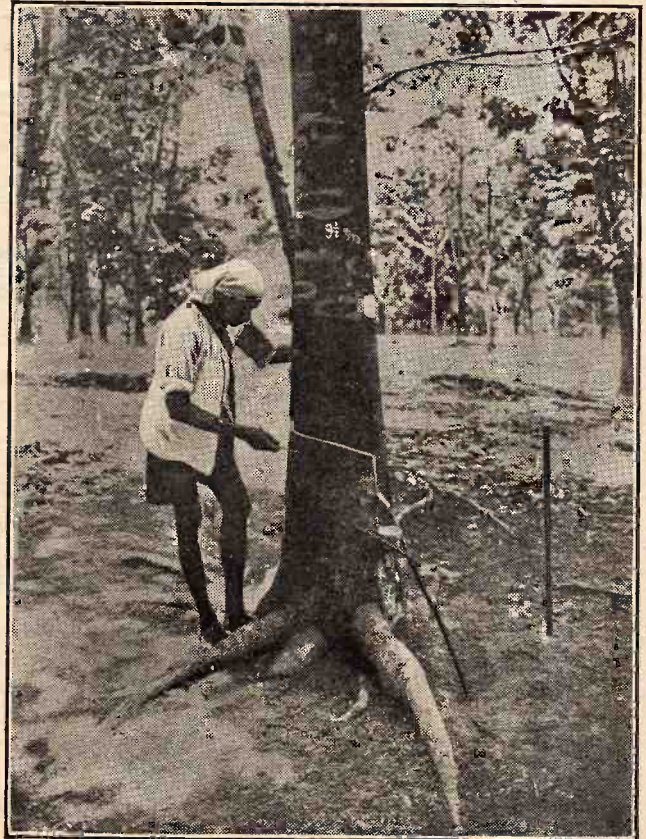

Tapping the rubber tree.

Insulators Tested—(1) Ebonite.—

Moreover, it is readily moulded into intricate shapes. A disadvantage of pure ebonite is its softening at high tropical temperatures. This, coupled with a high-temperature coefficient of expansion, causes the serious defect known as "cold flow," by which parts subjected to a rise in temperature whilst under pressure do not, upon cooling, return to their original shape, the expan-

sion causing a permanent distortion and the part having no definitely cyclic thermal expansion, a defect which is especially serious in inductances and air condensers.

Another disadvantage of ebonite is its deterioration with continued exposure to actinic light, an effect which may, in the near future, become more serious when our laboratories, and even our homes, are fitted with "Vita-glass" windows.

PARMEKO L.F. TRANSFORMERS.

A feature of special interest with regard to this transformer is that the inductance of the primary winding is maintained at a comparatively high and constant value when passing D.C. up to 15 mA. Consequently, it can be used to follow any type of L.F. valve, and many of the small power type, without causing magnetic saturation of the core.

This component should find a particularly useful application in power amplifiers, but this does not preclude its use in less ambitious sets, provided a high stage gain is not demanded.

The step-up ratio is 2 : 1, and used with a valve of 12,000 ohms A.C. resistance and an amplification factor of 11, the makers give the stage amplification as a little over 20, and this remains fairly constant from 50 to 7,500 cycles. The

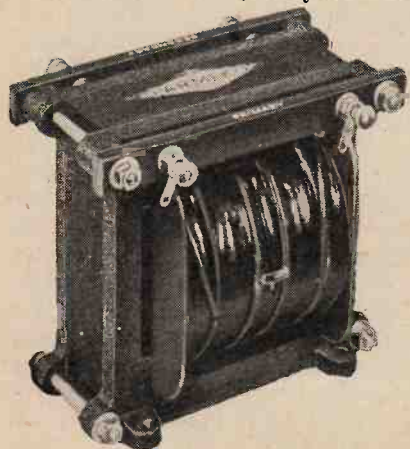

"Parmeko" constant inductance L.F. transformer, rated to carry 15 mA. of D.C. The ratio is 2:1.

measured D.C. resistance of the primary is 1,380 ohms.

The inductance of the primary was measured at 50 cycles, and with various values of D.C. flowing, the results being tabulated below.

D.C. in mA.	Superimposed A.C. in mA.	Inductance in Henrys.
0	0.33	82
4	0.33	82
8	0.34	78.7
12	0.36	75
16	0.38	71

These values compare very favourably with the figures supplied by the makers at the same frequency, which are given as 86 henrys with no D.C. flowing, and 75 henrys with 15 mA.s of D.C. Pos-

**LABORATORY TESTS
New Apparatus Reviewed.**

sibly the small discrepancy can be accounted for by the difference in the value of the superimposed A.C.

The primary and secondary are wound in sections, three forming the secondary with the two primary sections sandwiched between them. A core of generous size is used and tightly clamped by special cast end-plates. Paxolin bobbins are used to support the coils, which assures good inter-coil insulation. The overall size is 3½ in. x 3 in. x 3½ in., and the weight 3 lb.

The makers are Messrs. Partridge and Mee, Ltd., 74, New Oxford Street, London, W.C.1, and the price is £1 15s.

o o o o

C.D.E.S. CALIBRATION CHART.

The Croydon and District Electrical Service, 98, Cherry Orchard Road, East Croydon, have placed on the market a large calibration chart suitable for use when calibrating a receiver. The chart is printed on cartridge paper, and measures 15 in. x 16½ in. It is divided in large squares, each approximately 1½ in. square, and these are in turn subdivided in 100 small squares. They cost 6d. each.

The abscisse is marked in kilocycles, commencing at 527 at the top, and finishing at 1,391; there is, however, space for a slight extension either way if desired.

A feature of special interest is that the names of the principal broadcasting stations are printed in the left- and right-hand margins, with those on the left-hand side in order of, and corresponding with, their respective frequencies.

The horizontal base line is marked 0-180, and also 0-100 to suit the various engravings on condenser dials.

o o o o

VARLEY CONSTANT INDUCTANCE L.F. CHOKE.

The advantage of the constant inductance type of L.F. choke cannot be too well stressed, as the user can be sure that the actual value under working conditions is not far short of the rated value, provided the steady D.C. through the winding does not exceed the maximum it was designed to carry. Thus the element of doubt is removed.

The Varley component is an excellent example of the type mentioned above. Its nominal inductance is 20 henrys; the

makers giving the actual values as 21.5 henrys with no D.C., and 20.5 henrys with 100 mA.s of D.C. flowing. A sample was tested and the inductance measured with various values of D.C. flowing. These measurements were made at 50 cycles A.C.

D.C. in mA.	Inductance in Henrys.	D.C. in mA.	Inductance in Henrys.
0	28.25	60	24.2
10	27.2	70	23.5
20	26.2	80	23.1
30	25.3	90	22.6
40	25.1	100	22.2
50	24.75	—	—

The superimposed A.C. was 5.25 mA. with no D.C., rising progressively to 6.65



Varley 20-henry L.F. choke, the inductance of which is practically constant with between 0 and 100 mA.s. of D.C. flowing.

mA. of A.C. at 100 mA. of D.C. In the case of the maker's curve it appears that the A.C. was maintained at 1 mA. throughout, whereas during our test we kept the A.C. voltage across the choke constant. The measured D.C. resistance of the winding on the sample tested was 460 ohms.

The makers are Varley, Kingsway House, 103, Kingsway, London, W.C.2, and the price is 21s.

o o o o

A NEW PHILIPS RECTIFIER.

Philips Lamps, Ltd., Philips House, 145, Charing Cross Road, London, W.C.2, have recently placed on the market a new full-wave rectifying valve giving a maximum output of 60 mA. It is styled the Type 1821, and the maximum anode voltage is 250. The filament consumes 1 amp. at 4 volts. The price is 17s. 6d.

Constructional Details.

Adjusting the Ganged Condensers.

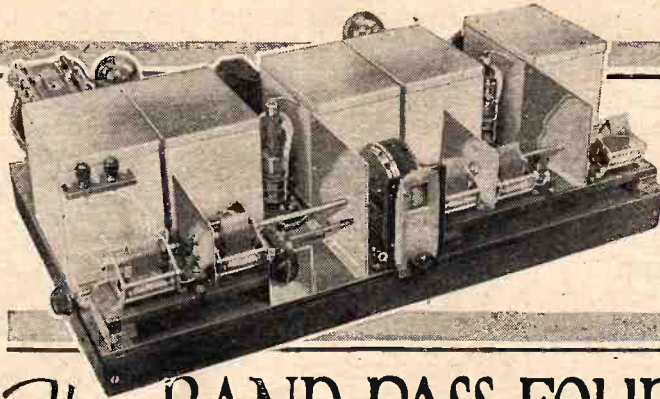

By
W. T. COCKING

(Continued from
page 665
of previous issue.)

The BAND PASS FOUR

THE actual construction of the receiver is not difficult, provided that it is carried out in the correct order, and that construction and wiring are carried on together. The components for the power-supply unit, the power-output stage, and the detector should first be mounted. Six wires should be attached to the six lower terminals of the mains transformer before it is screwed down, as these terminals will then be rendered inaccessible by the filter condensers. The wiring should then be carried out as far as possible. The H.F. valve holders, decoupling resistances, and by-pass condensers should next be mounted and wired, followed by the smoothing and by-passing condensers beneath the baseboard, and the various voltage-dropping and biasing resistances.

The switch assembly should next be placed in position, and care taken to see that it is working properly. The switches are most easily linked by lengths of $\frac{3}{32}$ in. \times $\frac{1}{4}$ in. steel, while the shaft for the control knob is made by filing down one end of a short length of $\frac{1}{4}$ in. silver steel to fit the switch connection. A small aluminium bracket serves as a bearing for the shaft. The screening boxes are next mounted, beginning with that containing the primary coils of the aerial filter (L_1 , L_2). They should be mounted one by one, and wired as completely as possible before mounting the next, two lengths of wire being left projecting from each box for connection to the variable condensers. Before mounting, the boxes should have soldering tags placed under the corner screws in the positions indicated in the wiring diagram; and two of the boxes must have an aluminium screen attached by the same means. The aerial and earth terminals are mounted on a small ebonite strip and attached to the front of the first screening box by three small brackets.

The second screening box contains the volume control, and this must be inserted after the small baseboard is mounted; an extension shaft of $\frac{1}{4}$ in. silver steel is coupled to it, either by a condenser coupling link, or by a home-made link made from a piece of ebonite or metal tube with a $\frac{1}{4}$ in. internal diameter, and two set screws. The front bearing for this shaft is made from a piece of thick sheet aluminium.

The drum dial should be mounted at the edge of the baseboard by two screws passing through the holes in the small bracket on the dial. The variable condensers (C_3 , C_5 , C_{14} , C_{16} , and C_{22}), and the equalising condensers (C_1 , C_6 , C_{15} , C_{17} , C_{23}), are mounted on strips of wood in the positions shown; great care must be taken to get them lined up accurately, and it may be necessary to pack up one or more of the condenser feet a little. The strips of wood are mounted on blocks screwed to the baseboard, and cut to the requisite thickness to bring the condenser spindles in line with the dial bushing. Small aluminium screens are mounted on two of the condensers (C_5 and C_{16}) by the one-hole fixing bushes. Two 13 in. lengths of $\frac{1}{4}$ in. silver steel are pushed through the condenser assembly from each end, and are fastened in the dial by the two grub screws; the vanes of the condensers should be so set that they are all in line, and the grub screws tightened up. The wiring can now be completed, and the volume control extension shaft finally mounted. It should be noted that the wiring is done with No. 20 gauge tinned copper wire run in insulating sleeving. All leads carrying A.C. are twisted, and all earth potential leads are bunched together.

Careful Adjustment of Coils and Condensers Essential.

The only operations required after the construction is completed are the adjustment of the equalising condensers, and the placing of the anode and aerial-circuitappings. These must usually be carried out together. At first, connect the aerial to the 15-turns tapping, and the two anode leads to the 40-turnsappings; in most cases it will be found that these are the best positions for permanent use. Set the volume control to maximum, and adjust each equalising condenser to minimum. Tune in as weak a station as possible on the main dial, and then tune it in to its best on the equalising condensers, increasing the main tuning dial setting, if necessary, to ensure that the station can be accurately tuned on each condenser. Having got the ganging approximately adjusted on some part of the medium waveband, tune in a station on about 275 metres and repeat. The ganging should then hold well

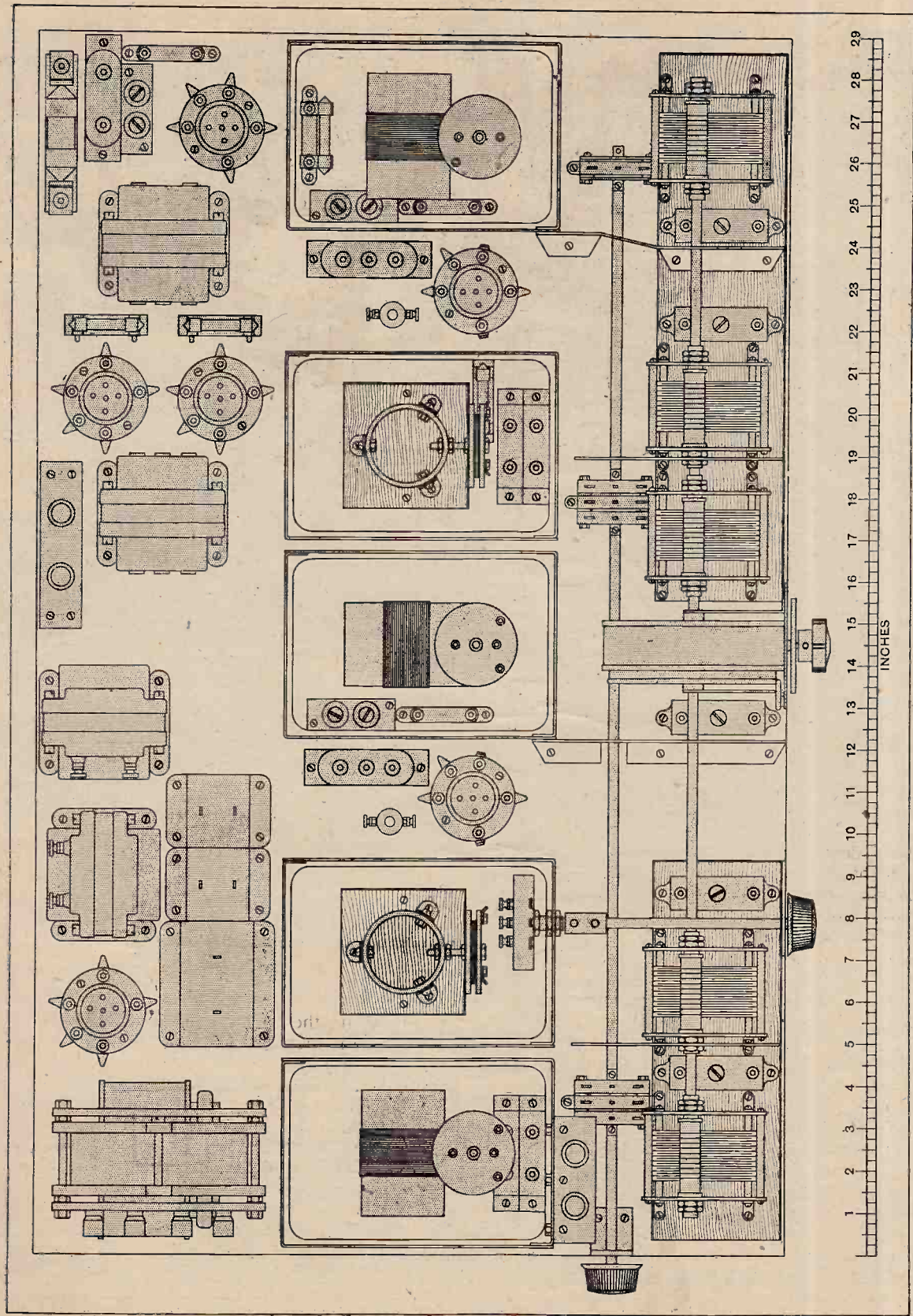

Practical plan of baseboard and under-baseboard wiring.

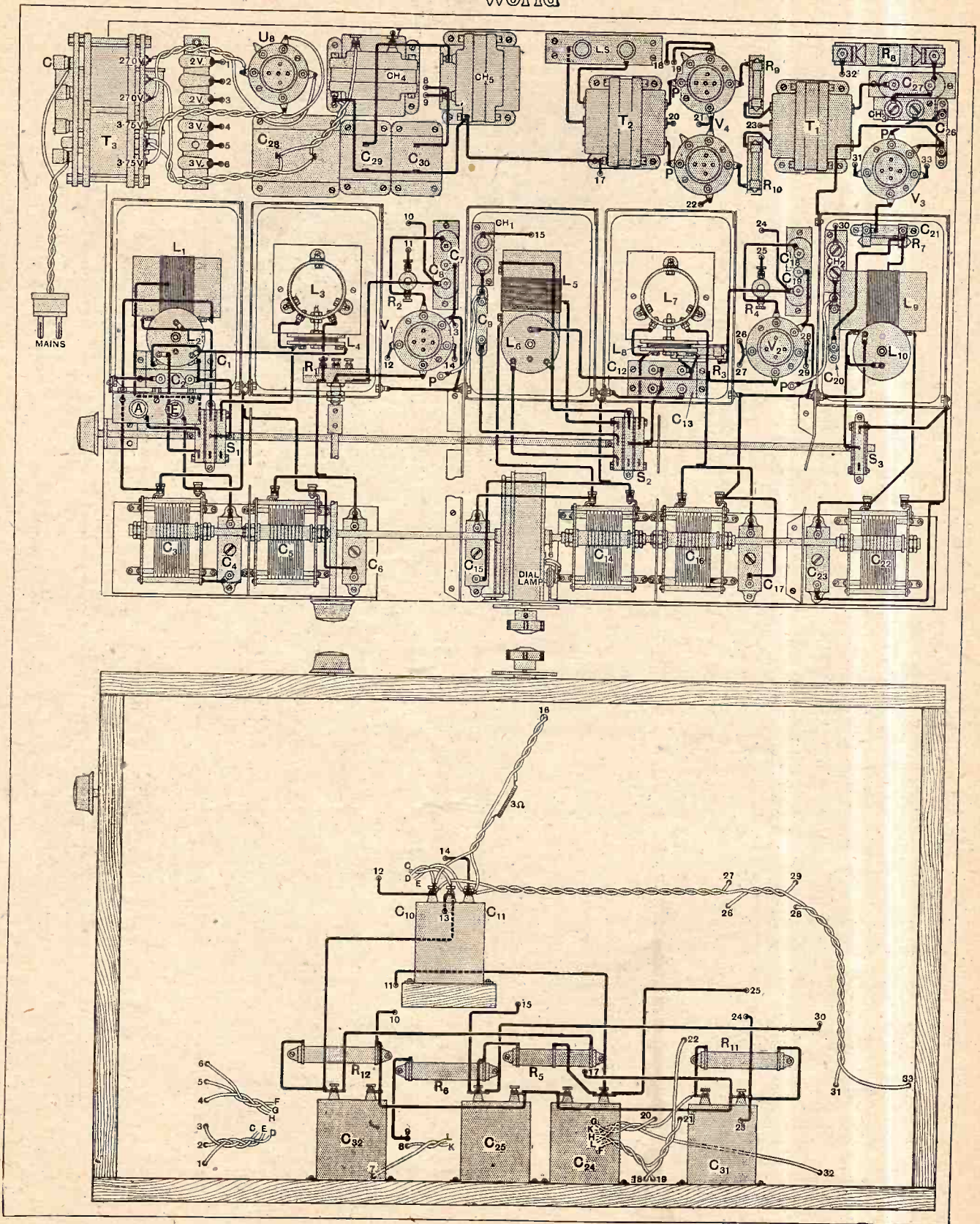

General layout of components.

The Band Pass Four.—

over the whole tuning range, and the set should be quite stable on both wavebands. On no account should the ganging be adjusted on the long waveband, as it will certainly produce inferior results on the medium waveband, besides giving too sharp tuning on the long waveband. The long-wave ganging is deliberately designed to be slightly out of tune, in order to assist the band-pass filters in preserving the high notes in the neighbourhood of 1,000 metres. Should the set be unstable at any point in its range, stability can be obtained by moving one or both the anode circuit tapplings to the 29 turns tap; if desired, however, oscillation can be stopped by means of the volume control, and this can be used in addition as a reaction control.

5XX; no trace of interference from either the National or the Regional stations is found on the long waveband. Koenigswusterhausen, of course, cannot be received, since it is spaced but 9 kc. from 5XX.

The sensitivity of a receiver is rather harder to define; the writer always judges it by the strength with which the Langenberg station is reproduced in daylight, since this transmission is fairly constant. It was found readily possible to obtain a detector anode current change of 0.8 mA. in daylight, indicating a very fair order of sensitivity. The long-wave stations, of course, would give far more than this; Radio Paris and Huizen, for instance, would choke up the detector unless the volume were drastically reduced.

The ganging holds quite accurately, and the set is

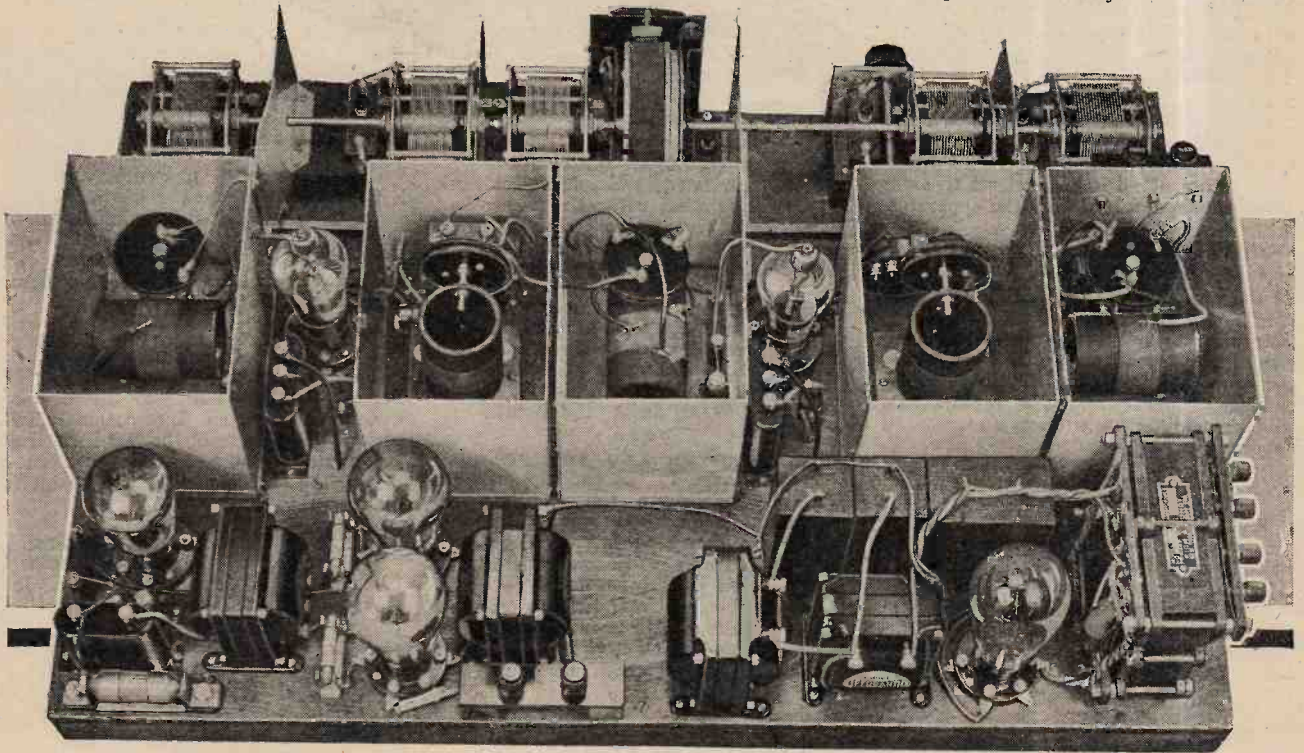

Plan view of the receiver.

The receiver has been tried out at about nine miles from the Brookmans Park station, and tests were undertaken to determine the selectivity. The frequencies were noted at which various stations just became inaudible with the volume control set at maximum in daylight. It was found that the National station was audible at all frequencies within the tuning range higher than 1,075 kc., the Regional station at frequencies between 910 kc. and 790 kc. a band width of 120 kc.; the Midland Regional station only occupied 52 kc.; while, on the long waveband, interference from 5XX was confined to a waveband of 20 kc. This test was rather severe, since it was conducted in daylight, and there was no transmission on an adjoining wavelength. At night, stations within these frequency bands can be received quite free from noticeable interference. Toulouse can be received free from the Regional programme, while on the long waveband Radio Paris is quite free from

extremely simple to tune, since there are only the tuning control and the volume control which require adjustment. The quality of reproduction is an even harder thing to define than selectivity and sensitivity; but, judged aurally, frequencies up to 6,000 cycles appear to be present in the output, while there is no reduction in the bass. Amplitude distortion is quite unnoticeable provided that the detector is not overloaded.

In conclusion, it may be remarked that a milliammeter with a range of 0-10 mA. is an extremely useful accessory. It should be included in the detector anode circuit, and with its aid it is possible to avoid any chance of detector overloading by restricting the anode current change to 1.2 mA., and it will also serve as a measure of signal strength. It renders tuning considerably easier, since one tunes for maximum deflection of the needle instead of maximum volume; and visual tuning is far more accurate than aural.



CURRENT TOPICS

Events of the Week in Brief Review.

BELGIUM'S RADIO POLICE.

The first radio police force in the world is to be formed in Belgium, the exclusive duty of its members being to trace and prosecute offenders against the wireless regulations. Article 9 of the new Wireless Law entitles any magistrate suspecting the use of an unlicensed set to enter the premises and confiscate the apparatus.

RADIO LUXURY IN MOSCOW.

A wireless "palace," apparently similar to the projected R.C.A. building in New York, will shortly arise in Moscow, according to a message from a Continental correspondent. The palace will contain twenty-seven broadcasting studios, a huge technical library of radio books, and, in addition, a wireless museum and laboratory.

SPAIN TO REORGANISE BROADCASTING.

A central 30-kilowatt station is the chief item in the latest plans for the reorganisation of Spanish broadcasting. In addition to the main transmitter, four 18-kilowatt stations would be erected at Madrid, Barcelona, Valencia, and Vigo respectively, with an additional 15-kilowatt station working on short waves.

HUSH!

"Whispers are around of a revolutionary wireless discovery that will make possible a crystal set that will be portable . . ."—*Empire News*, Manchester.

THE CARAVAN "PIRATE."

A labourer fined at Keighley last week for operating a set without a licence had installed a three-valve receiver in a caravan. He pleaded that a licence was beyond his means.

STILL THEY COME.

On May 31st the total number of wireless receiving licences in force amounted to 3,144,626, including 16,764 free licences issued to the blind. This makes an increase of 27,000 during the month.

THE AMATEUR AND THE POLICE.

In a message to the amateur wireless fraternity in France, the French police authorities request that any amateur picking up the "secret" wavelength of the Eiffel Tower police transmitter will refrain from publishing it. The wavelength is changed from time to time, as also the code, but it is felt that anyone continuously intercepting the signals would soon arrive at their meaning.

IRELAND'S RADIO SHOW.

The probable dates of the Irish Free State Wireless Show for 1930 will be October 20th to 25th at the Mansion House, Dublin. The Irish Radio Traders' Association are the organisers.

THE POPULAR PORTABLE.

Of America's listening public, 78.8 per cent. use portable wireless sets while on holiday, according to a statement issued by the Federal Radio Commission. The majority of hotels and boarding houses supplying radio facilities.

INTERNATIONAL TELEVISION CONGRESS.

The International Institute of Television, founded last year in Brussels, announces that an International Television Congress will be held in July, 1931. Prominent inventors and personalities in the television field will be invited to attend.

DEATH OF MARCONI PIONEER.

We regret to record the death at Chelmsford on June 14th of Mr. Jack Cave, one of the earliest technical employees of the Marconi Company. The late Mr. Cave, who was in his 58th year, was appointed as instrument maker on the personal staff of Marchese Marconi in 1897, and specialised in coherer manufacture and testing.

'PHONE TO NEW ZEALAND?

In the House of Commons last week Mr. Lees-Smith (Postmaster-General) stated that he understood that experiments were at present being conducted with a view to the establishment of a wireless telephone service between Australia and New Zealand, and that it is hoped that this service will be linked up with the Anglo-Australian wireless telephone service.

W.B.E.

A new certificate is now being issued by the Incorporated Radio Society of Great Britain to those transmitting members who have communicated with a station in some part of the British Empire, situated in each of the five continents. It is called the W.B.E. certificate, the letters standing for "Worked the British Empire."

We learn that the certificate is being keenly sought after, not only in Britain, but in the Dominions and Colonies.

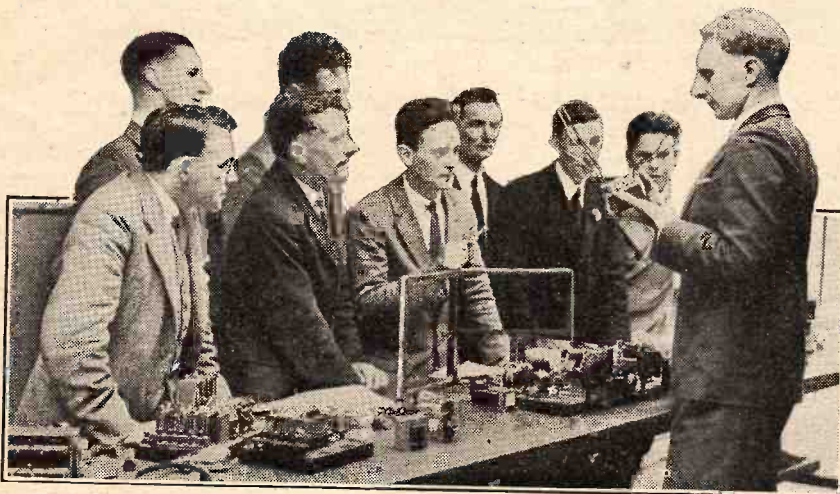

WIRELESS IN A NUTSHELL. High speed courses for radio dealers are now conducted by the Marconiphone Company at Dagenham, Essex. The photograph shows a lesson in progress.

AUSTRALIA AND IMPORTED WIRELESS SETS.

Wireless sets and gramophones are included among articles on which the Australian Minister for Trade and Customs proposes to increase the customs duty. The House of Representatives at Canberra is considering the proposals.

CABLE-WIRELESS MERGER MEETING.

We understand that the annual general meeting of Cables and Wireless is fixed provisionally for Tuesday, July 15th at the Cannon Street Hotel.



"ELIMINATING" UNEMPLOYMENT.
Two views of the great factory now under erection at Priory Park, Southend-on-Sea, for Messrs. E. K. Cole, Ltd., manufacturers of the "Ekco" battery eliminators. When the factory is complete nearly two thousand workers will be kept busy, the whole of the unemployed in the Southend area being absorbed.

WARNING TO ILLICIT TRANSMITTERS.

A touching plea to "clandestine" transmitters to legalise their stations was made by M. Lefebvre (2GL), president of the French Transmitters' Association, at the sixth annual meeting, which has just terminated its sessions in Paris. In the course of his appeal, M. Lefebvre pointed out that the police are ever watchful for illicit transmission and are ready to prosecute rigorously whenever an offender is caught.

Among the resolutions passed at the congress was one demanding that all high-power transmitting stations should be

placed at a good distance from cities and large towns.

TECHNICAL TRANSLATORS.

All who have ever fretted over the "translation" by a non-technical person of a technical work in a foreign language will heartily congratulate the Association of Special Libraries and Information Bureaux on its decision to form a panel of expert translators.

"Proficiency in language is not enough," says the association. "The translator must have a really close acquaintance with the subject he has to translate."

To overcome existing difficulties the Association is working on a scheme to establish a panel of translators having special qualifications.

SHORT WAVES FROM SCHENECTADY.

Short-wave listeners will be interested in the new operating schedules of the G.E.C. stations at Schenectady, which are as follow :-

Sundays, Tuesdays and Thursdays:
W2XAD, 1800 to 2400 G.M.T. ; W2XAF, 2300 to 0200 G.M.T.

Mondays, Wednesdays and Fridays:
W2XAD, 2100 to 2400 G.M.T. ; W2XAF, 2300 to 0200 G.M.T.

The 7 Megacycle Waveband.

Commenting on the paragraph on page 515 of our issue of May 14th, Mr. C. G. Phillips, G5PJ, agrees with G6PP that short-distance contacts are extraordinarily difficult at present, and have been so for some weeks. He seldom hears any English amateurs on the 7 megacycle waveband, and, except for a short time at dusk, finds it difficult to work with French or Belgian stations. On the other hand, more distant European stations, as those in Czechoslovakia and Poland, are being heard well in the day-time, and contacts are frequently made with signal strength reported as R5 or R6. Both these conditions are in direct contradiction to those experienced a year ago. Mr. Phillips states that he is carrying out Solar observations, but has not noticed any connection between the diurnal variation of sun-spots and the conditions of short-wave reception.

Mr. R. Holmes, G6RH, writing from Liverpool, has also observed that English

TRANSMITTERS' NOTES AND NEWS.

stations working on the 40-metre waveband are inaudible or, at best, very faint and subject to considerable fading, whereas more distant stations, such as EAR39, EU CSKW2, Moscow, and one in the Canary Islands, have been received at good strength. Mr. Holmes has found the 20-metre waveband unsatisfactory for the last few months, but considers that it is now getting better every day. This may possibly be attributable to increasing experience, as we understand that he has only been working for a short time on a full transmitting licence, unrestricted by the limitations of an artificial aerial.

On the 14-megacycle band he has worked with six stations in districts 1, 2, and 8, of U.S.A., Newfoundland, Canada, French Morocco, Iraq, and a

number of European stations. The best signal report came from YI 1CD in Iraq. Mr. Holmes is anxious to get into regular communication with Australia and South America.

Short-wave Working in New Zealand.

A listener in Canterbury, New Zealand, sends an interesting report of short-wave signals heard by him. In a letter dated April 4th he records having heard Marchese Marconi speaking from his yacht in Genoa to Amalgamated Wireless, Ltd., at Pennant Hills, New South Wales, and VK6AG testing from Inglewood, West Australia, with VSIAB in Singapore on about 42 metres. The signal strength on this occasion was only about R2-3 but as the modulation was extraordinarily good he had not much difficulty in overhearing. The distance between Singapore and Canterbury, N.Z., is about 4,000 miles, with the Continent of Australia intervening; at the time of writing the correspondent was unable to say what power to the aerial was being used by these stations.

A NEW A.C.

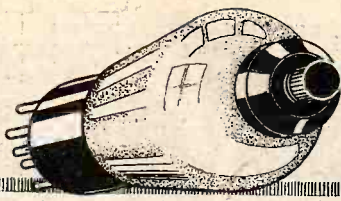
SCREEN-GRID
VALVE

Remarkable Figures of the Mullard S4VA Valve.

THE latest addition to the range of Mullard screen-grid valves has remarkable characteristics. The residual interelectrode capacity has been reduced to the lowest value yet obtained, namely, about 0.001 μF , making it possible to attain with a specialised coil a single stage gain of nearly 1,000, whilst with a cheap 2in. coil the stage amplification is over 200 times. By drawing load curves across the anode volts/anode current characteristics it can be seen that with a good coil only 1/5th volt (peak) grid swing can be accepted before rectification and cross modulation occur with apparent loss of selectivity. The small input that can be accepted should not be detrimental in a receiver in which a volume control is arranged before the S.G. valve.

THE improvement in valve characteristics shows no sign of abating, and set designers are perpetually being offered new and more efficient valves. The latest advance in screen-grid valves is the Mullard S4VA which, like the S4V that it supersedes, is intended for operation from the mains.

The appearance and construction of the valve follow what has now become almost standard practice. The valve is of normal size, and has the usual five-pin base, with the anode connection at the top of the bulb. The electrodes are sturdily constructed, and the screening-grid is of the square "box" pattern with the anode, in the form of two separate flat plates, outside it. Just above the pinch the screen spreads out into a circular disc that practically fills the bulb; the turned-over edge of the disc shows the position which the external screening must have in relation to the bulb in order that it may carry on correctly the screening within the valve.

The official characteristics of the valve, as given by the makers, are as follows:—

Max. heater voltage	4.0 volts.
Heater current	1.0 amp.
Max. anode voltage	200 volts.
Positive screen voltage	75-100 volts.
¹ Anode impedance	430,000 ohms.
¹ Amplification factor	1,500
¹ Mutual conductance	3.5 mA./volt.

As will be noticed, the working voltages are rather higher than is usual in valves of this type, which argues well for its amplifying powers; but the most striking feature is the value of the mutual conductance or slope, which is extraordinarily high for a screen-grid valve. A slope of 3 milliamps. per volt has not previously been reached in any valve save a few exceptionally good ones of low impedance; to attain so high a figure in conjunction with so enormous an amplification factor is an achievement of which the makers may well be proud.

On checking the characteristics of the valve it was found that the rated figures of slope, amplification factor, and A.C. resistance were exactly correct for the sample under investigation. Since even better characteristics might reasonably be expected with the highest permissible anode and screen voltages, the next measurement

was directed to finding the mutual conductance under these conditions, but with $-\frac{1}{2}$ volt on the grid. The figure found was 4.7 mA./volt, rising to 5.1 mA./volt with 125 volts on the screening grid.

After these preliminary measurements a full set of curves, including one of grid-current, was taken. These are shown, in the familiar form of mutual conductance curves (grid volts— anode current) in Fig. 1. It will be observed that grid-current starts when the grid of the valve is a little over 1 volt negative with respect to the cathode; in recognition of this, the curves are shown as dotted lines between $E_g = -1$ and $E_g = 0$. Owing to the grid-current damping that would result, the curves in the "dotted" region cannot be used, so that the highest

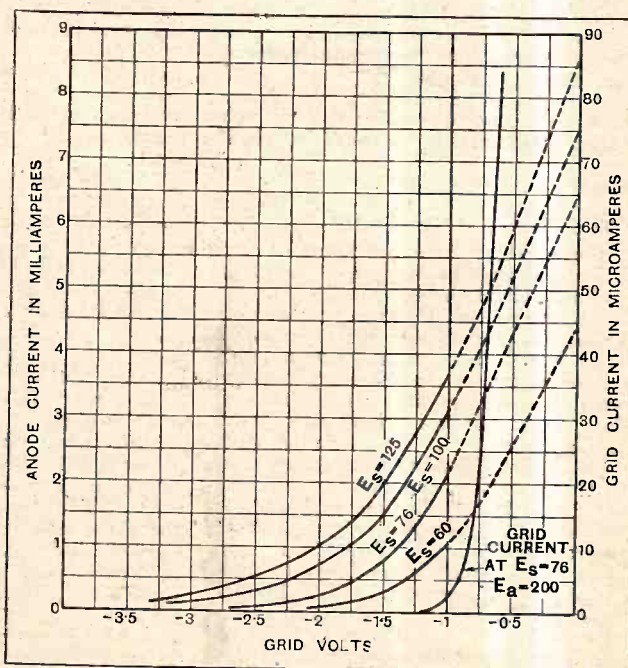

Fig. 1.—Grid volts/anode current curves of the S4VA valve. The anode current throughout is 200 volts and each curve refers to a different screen-grid voltage. Note that grid current starts at about -1 volt, therefore the dotted part of the curves do not represent working conditions.

¹At anode volts 100; screen volts 75; grid volts 200.

A New A.C. Screen-grid Valve.—

values of mutual conductance that have been quoted are not available in an actual receiver.

Figs. 2 and 3 show impedance curves (anode volts— anode current) for screen-grid voltages of 76 and 100 respectively. For the sake of showing the most important part of the curves on a larger scale, only that region which relates to anode voltages greater than the screen-grid voltage in use is included. On the assumption that the valve would be worked at the maximum rated voltages, and with a grid bias of $1\frac{1}{2}$ volts, load-lines have been drawn across Fig. 3 to represent tuned circuits of several different values of dynamic resistance.

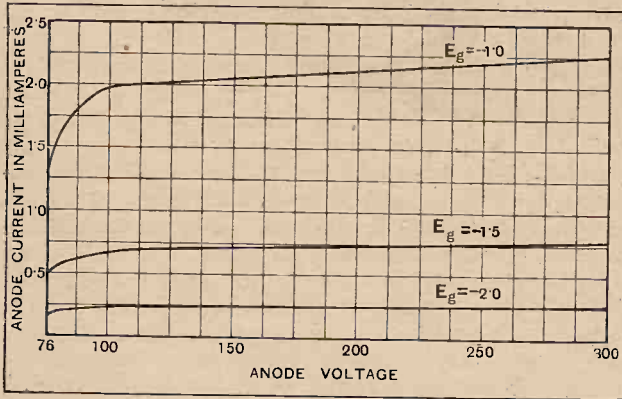

Fig. 2.—Anode volts/anode current curves taken with a screen-grid voltage of 76 in all cases. These can conveniently be called impedance curves.

The grid-swing with which the valve will deal is thus shown to be very small indeed, being not more than one-fifth of a volt on either side of the steady bias if the tuned circuit has a dynamic resistance of 200,000 ohms. The smallness of the input that can be accepted, however, is not in any way detrimental in practice, for at the operating voltages quoted the valve will hand on to the valve that follows it a grid-swing of nearly 150 volts without introducing serious distortion of the waveform, or permitting an unwanted signal to pass through the receiver as a modulation of the signal being received. Even with an anode-circuit load of no more than 50,000 ohms an output of about 50 volts (total swing) can be obtained. The S4VA may therefore be used to feed detectors requiring even the largest inputs without involving the user in any loss of selectivity.

Under Working Conditions.

The A.C. resistance and amplification factor of any screen-grid valve, measured under operating conditions, is liable to be widely different from the values determined under the highly artificial conditions laid down by the B.V.A. The S4VA is no exception to this rule, as consideration of the curves of Fig. 4 will immediately show. Under normal conditions of operation no value of screen-grid voltage can be found for which the rated values of μ and R_o are even remotely correct; the A.C. resistance of the valve, for example, is always over a megohm. Rules are rules, and we do not grumble at the makers for quoting the characteristics taken under the standard conditions, but we would draw the attention of

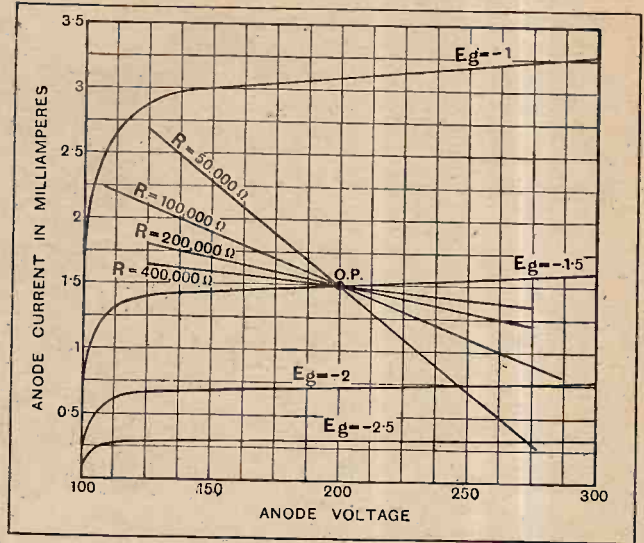

Fig. 3.—Load lines plotted through the operating point on the impedance curves, avoiding grid current. The screen grid was maintained at 100 volts positive throughout. It can be seen that when the anode load due to the dynamic resistance of a tuned circuit is 200,000 ohms, the available grid swing is a small fraction of a volt.

readers to the very different values assumed by the valve when the correct operating voltages are applied. By merely changing the grid voltage from zero to $-1\frac{1}{2}$, keeping the other voltages at the values of the official test, the A.C. resistance of the valve is increased over ten times, while the amplification factor is increased rather more than three times. So long as one knows of this effect it does not much matter, but the values of Fig. 4, and not the official characteristics, must be used as the basis of receiver design.

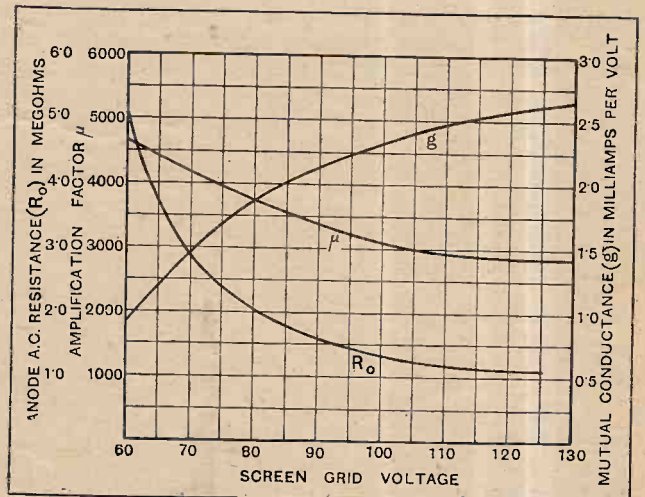

Fig. 4.—Variation of amplification factor μ , A.C. resistance R_o and mutual conductance g with operating voltages. Throughout the anode voltage is 200, and the grid voltage $-1\frac{1}{2}$. The values of μ , R_o , and g are those which hold under working conditions, and may be used with confidence in design calculations.

Over the whole of the range of operating voltages the screen-grid current is consistently low, being of the order of a quarter of a milliampere. The screen should therefore be provided with its voltage by using a potentiometer, which need not draw more than about 2 milli-

A New A.C. Screen-grid Valve. —

amps. from the H.T. supply. A series resistance direct to H.T. + will not provide satisfactory voltage control unless its value is chosen from measurements made on the individual valve to be used. A particularly satisfactory arrangement, which includes a pre-detector volume control, is shown in Fig. 5.

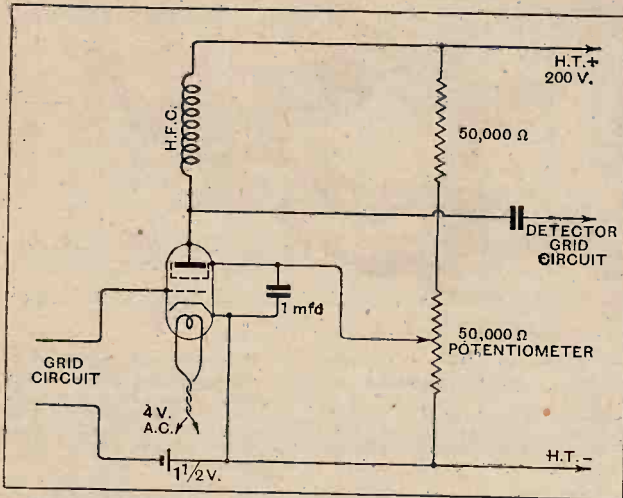

Fig. 5.—High-tension potentiometer for providing a suitable screen potential. By making the slider cover only half the available voltage a very convenient volume control is obtained, without risk of inadvertently applying a dangerously high voltage to the screening grid. So long as both potentiometer and fixed resistance have equal resistances, it does not matter, within reason, what values these resistances have.

Stage-gain Measurements.

Although Fig. 4 gives practically all the information about the S4VA that one is likely to need, some measurements of stage-gain were made as a matter of interest. For all the measurements the tuned-grid circuit, as shown in Fig. 6, was used. Various coils, good, bad, and indifferent, were put in in turn, and the values of stage-gain, measured in all cases at 300 metres, were found to be as follows:—

Record III Coil (400 μ H when not screened); detector valve decapped.	850 times.
3in. Litz coil on ribbed ebonite former 260 μ H; detector valve not decapped.	435 times.
2in. coil of solid wire. 200 μ H.	280 times.
Commercial 2in. solenoid, 175 μ H, with shorted long-wave coil on same bakelite former.	210 times.
Plug-in coil, 200 μ H, with layers well spaced (Gambrell B).	160 times.
Basket coil of 22 d.o.c. wire, approx. 200 μ H, in holder.	220 times.
60-turn plug-in multilayer coil, 240 μ H, with no spacing between layers of wire.	75 times.

So far as the writer knows, the gain of 850 times in a single stage sets up a new record in high-frequency amplification, though such enormous amplification can only be attained at the cost of considerable pains in the construction of the tuned circuit connected to the plate of the valve. With a plain tuned-anode circuit, with which the small losses due to the high-frequency choke would be avoided, and with the grid-bias reduced to $1\frac{1}{2}$ volts, it is even possible that the stage-gain might rise to 1,000 times.

¹ These figures were checked by calculation based on the measured characteristics of valve and tuned circuit; theoretical stage-gain 840 times and 270 times respectively.

The other figures for amplification, obtained with less exceptional tuned circuits, and with the detector valve inserted normally into a carefully chosen holder, are less sensational but of greater interest. They will well repay careful examination, since each coil chosen was a representative sample of its type. It is interesting to note that our old friend, the basket coil, puts up an unexpectedly good performance.

Interelectrode Capacity the Lowest Yet.

A valve which is capable of producing such exceptionally high stage-gain as the S4VA, if it is to be of any value in a receiver which does not employ neutralisation, must have a lower value of residual anode-grid capacity than is usually attained in screen-grid valves. In other words, the screening must be unusually effective if stability is to be retained in face of such high amplification. The makers have informed us that they believe the residual anode-grid capacity to be about 0.001 micromicrofarad, but that owing to the difficulty of making accurate measurements of so minutely small a capacity, they are at present not prepared to guarantee this figure. We have ourselves attempted to measure this capacity by an indirect method, but have been able to come to no conclusion save that it is quite certainly less than 0.0025 $\mu\mu$ F., and very probably less than 0.0015 $\mu\mu$ F. Whatever the exact figure, we are left in no doubt whatever that the internal screening of this valve is of the very highest standard, so that the remarkable figures for amplification can be made use of, even to the fullest extent,

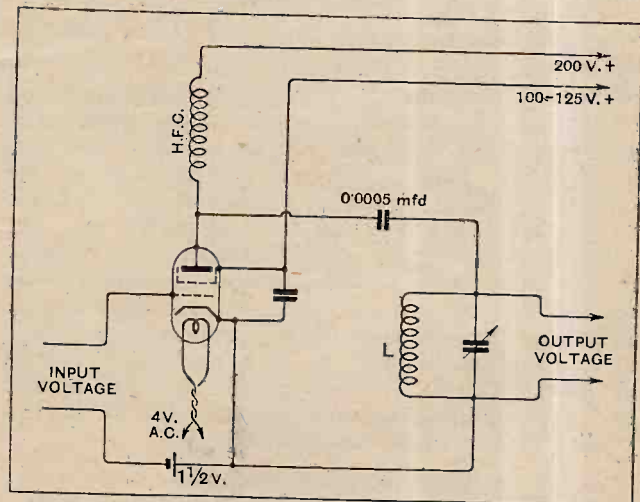

Fig. 6.—Circuit used for stage-gain measurements. Various coils, as described in the text, were used in the position of L, and the stage gain at 300 metres was noted for each.

in a practical receiver. Used in a Record III receiver, the neutralising arrangements of that set should not be required if sources of illegitimate coupling external to the valve are satisfactorily eliminated.²

The measurements that have been discussed cover fairly thoroughly the points of interest concerning the electrical properties of the valve as such. In view of the fact that it will inevitably be used with a tuned

² This statement will not necessarily hold if the S4VA, as well as the detector, is de-capped.

Valve.	Max. Anode Voltage.	Optimum Screen Voltage.	Average Anode Current (mA.).	Amplification Factor.	A.C. Resistance.	Anode Grid Capacity ($\mu\mu\text{F}$).	Max. Stage Amplification Un-neutralised.	H.F. Performance Factor.	Optimum Transformer Ratio.	Stage Amp. with 3 to 1 Transformer.	Price.
MULLARD. S4VA..	200	100	1.5	3,100	1,300,000 ohms	0.001 (approx.)	634 ¹	272	1.0	200	25/-

¹ On the assumption of equal dynamic resistance in grid and anode circuits.

This table is on the lines of "The Wireless World Valve Data Sheet" (December 4th, 1929) and gives the characteristics of the valve under actual working conditions: *i.e.*, with maximum voltages on anode and screen, and with $-1\frac{1}{2}$ volts grid bias. For further details, see "The Wireless World," December 4th, 1929, page 614.

circuit connected between grid and cathode, it is necessary also to have some idea of the losses introduced into that tuned circuit by the material of which the base is made. The unusually high excellence of the valve in all respects other than this led us to hope that the question of losses in the valve base had also received the careful attention of the designer, but on connecting the valve, unlighted, in parallel with a tuned circuit, we were sadly disappointed. We found that at 250 metres the losses introduced were equivalent to connecting a resistance of about 370,000 ohms in parallel with the

tuning condenser or a shunt conductance of $2.7 \mu\text{mnos}$. When the inductance preceding the valve is a plug-in coil of obsolete design, this loss would not be of great importance, but with any more modern coil than this the losses in the valve base would be seriously detrimental both to sensitivity and selectivity. We would deferentially suggest that some more suitable material be found for the valve-base, or a better cement, if that is the culprit, be chosen for attaching it, for one does not like to see even the smallest blemish in a valve of such outstanding excellence in all other respects.

POSSIBLE FORMS OF WAVE-TRAP.

Two Methods of Eliminating Unwanted Signals.

THE twin-programme transmitter must have turned the thoughts of innumerable users of simple sets in the direction of wave-traps of various types. There can, of course, be little doubt that the wave-trap does not provide the best possible means of securing selectivity, for it is in many ways but a poor second to the fully tuned and loosely coupled aerial circuit. If one were building a set for high selectivity, one would normally make use of the loose-coupler, or filter circuit, ignoring the wave-trap completely. But if it is a question of adding a little extra equipment to a receiver that is already in existence, the wave-trap is usually preferred, for the very sound reason that it is not usually easy to devise a satisfactory mode of coupling between the two coils of a filter-circuit when one of these is already built into the set.

Wave-traps are of several forms, and no one can be universally recommended in preference to the others. Two of the possible circuits are shown in the diagram, in which (a) shows the common "series trap." It will be seen that the trap is inserted between the aerial terminal of the receiver and the aerial itself. When correctly tuned it interposes a barrier of high impedance to the unwanted station, but of low impedance to signals of other wavelengths, in the path along which all signals must come. Tappings are usually provided so that the trap can be used to the best advantage with either long or short aerials.

At (b) is shown a type of absorption trap, working in rather a different way. It is connected across aerial and earth terminals of the set, and, when tuned to the

local station, offers so low an impedance to signals on that wavelength that it acts towards them as a virtual short-circuit. This type of trap has very marked advantages when the aerial is coupled to its coil by means of a small untuned primary, or is joined to a tap low down on the coil. With receivers using other modes of connection it is usually not satisfactory.

It should be noticed that both circuits require exactly the same components, so that in making up a trap it is best so to arrange the terminals that it may be connected in either of the two ways. A little experimenting will soon show whether (a) or (b) is the better for the particular set and aerial in use.

A. L. M. S.

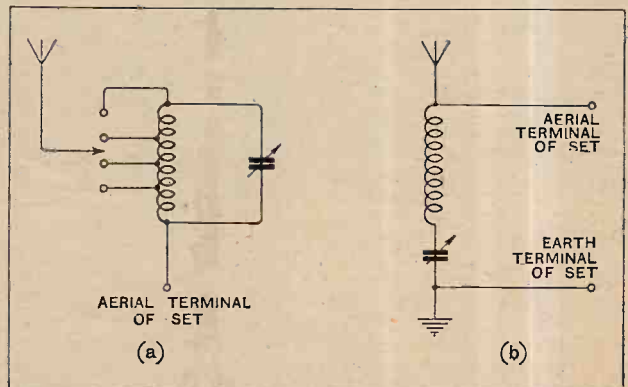

Two forms of wave-trap. (a) A series trap forming a barrier of high impedance to the unwanted station. (b) An absorption trap which offers a low impedance to the interfering signal.

Logging the



Amateurs' Twenty-Four Hours' Vigil.

By N. R. BLIGH and H. A. CLARK

ONE of the salient features of the Transatlantic flight made by Major Kingsford-Smith and his three companions in the "Southern Cross" was the use of wireless telegraphy with which they kept in touch with the rest of the world during their lonely hours over the sea. It was arranged that transmission should take place from the aeroplane on two wavelengths, viz., 600 and 33 metres.

Before dealing with the special arrangements made by the Radio Society of Great Britain and the General Electric Company for a continuous amateur watch in this country, it may be interesting to consider the type of wireless installation on the mammoth Fokker monoplane.

The equipment consists of two separate transmitters, one for 600- and 800-metre working, manufactured by the Marconi Company, and one for short waves. The short-wave transmitter is an American set made by Heintz and Koffman and consists of a simple tuned-plate tuned-grid circuit. The set is completely enclosed in an aluminium box. The only control is the tuning condenser in the grid circuit. There is a hot-wire aerial ammeter, 0.2 amps., in series with the aerial, which is coupled by a few turns to the anode coil. The aerial for the short-wave set hangs from the machine immediately below the transmitter. A maximum aerial current is obtained by adjusting the length of trailing aerial and the grid circuit tuning condenser, the anode circuit being tuned by means of a fixed condenser. Everything is done to eliminate weight, and the tuning coils themselves are wound of hollow aluminium tubes to assist in this direction.

The long-wave transmitter and receiver are operated on a separate aerial on the other side of the cabin. This aerial, being much longer (up to 300ft.), falls at a much steeper angle to the body of the plane, and hence clears the short-wave aerial. The sets are mounted in a light wooden frame, from which they are slung by rubber cords.

Both the transmitters work from the same supply, which is a wind-driven generator. This is of the permanent magnet type, and has two separate windings for L.T. and H.T. The high tension voltage is obtained by means of a step-up transformer. Keying is done in the transformer circuit.

This generator is so designed that with its correct load the output is independent of the air speed, and delivers A.C. to the anodes at about 250 cycles.

The receiver, which is contained in an aluminium screening box, is seen in the centre of the picture on this page. A three-valve circuit is used, giving reception on 600 to about 2,000 metres, the input circuit being tuned for long waves, but aperiodic for the shorter wave band. The first valve is an Osram S.215, and an Osram HL210 is used as a leaky grid detector.

It has been found impossible to receive on 30 metres while in the air owing to the serious electrical interference from magnetos; thus reception is confined to 600-metre shipping traffic and direction-finding stations on about 2,100 metres on the American coast.

Now let us turn to the arrangements made in this country to receive the short-wave signals. The Radio Society of Great Britain, in conjunction with the General Electric Co., arranged

for as many amateur stations in this country as possible to maintain a listening watch during the hours of the flight. As many stations as possible were asked to stand by on 33 metres, and it is anticipated that a great deal of useful information will be obtained when the full details of their reception are available. At the moment of going to press, however, we can only describe the flight as heard by the operators at G6OT, Harringay, London, N. Three men were available in order that emergencies could be dealt with without disturbing the third man, who was resting. It was arranged to have at least two receivers working on 33 metres to ensure that reception should not fail due to receivers breaking down.

Unfortunately, listening was not commenced until some hours after the "Southern Cross" had left Portmarnock, near Dublin, on June 24th, but one of the early messages originating from the VMZAB (the call-sign of the "Southern Cross"), which was addressed to G6OT, was fortunately intercepted by G6PP and received indirectly. The latter station was standing by during practically the whole flight, and obtained a very fine log.

The signals during the first four hours were remarkably

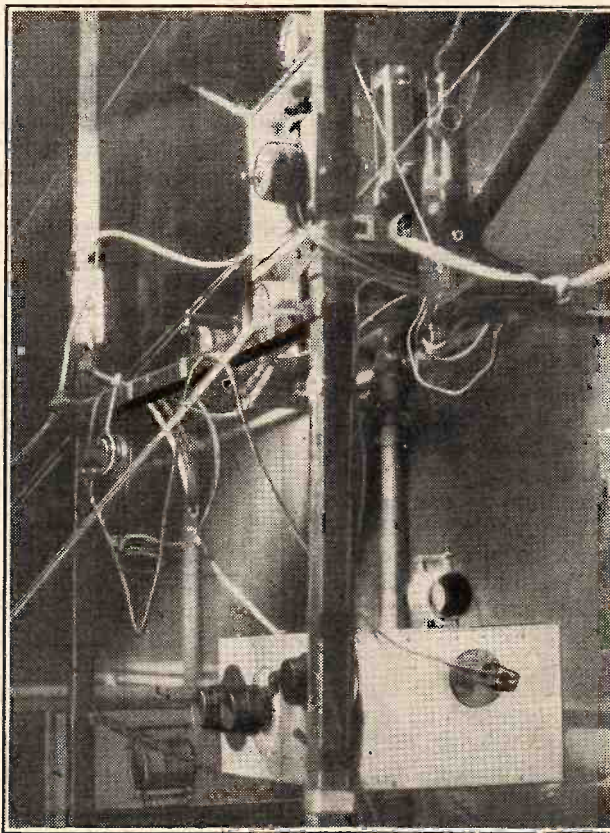

A glimpse in the rear cockpit of the "Southern Cross," showing the all-enclosed short-wave transmitter from which the signals were received. Below is the short-wave receiver.

Logging the Southern Cross.—

strong and easy to copy. Transmissions were received from the aeroplane almost every quarter of an hour. These generally indicated the cheerful and optimistic spirits of the men on board, and contained information as to weather conditions and a number of messages to private individuals. Signals continued to be very easily readable until about 12.30 B.S.T., when heavy jamming was experienced from the Italian short-wave station IDO. Unfortunately, this station, which operated for many hours on end during the flight, caused very serious interference with the reception of the "Southern Cross." This was accentuated by a simultaneous decrease

it was possible to receive the aeroplane's signals with the telephones lying on the bench. At about this period the pitch of the note of VMZAB was noticed to be varying a great deal and "bumpy" weather was reported from the aeroplane. Signals improved steadily during the next three-quarters of an hour, and many messages were copied on the Igranic three-valve receiver with no aerial connected.

At various intervals during the flight bearings were given, and great excitement was experienced while plotting these out on an Admiralty chart and thus mapping the course of the "Southern Cross." At 2 o'clock the aeroplane was only some 400 miles from Cape Race, Newfoundland. Efforts were made by Mr. Stannage to get a wireless bearing from the Cape Race station, VCE, but without success. Further efforts were made on both 600 metres and 33 metres to establish communication with VCE at intervals up to 4 a.m., at which time the occupants of the machine considered that they were only an hour's journey from Newfoundland.

Up till now the remarkable signal strength was maintained, but soon after break of day the strength of the signals began to fall. At 5 a.m. messages were received indicating that the fliers were none too sure of their actual position, and also that great difficulty was being experienced in the flight with that fatal enemy to long-distance flying—sleep. At 5.15 a.m. the first streak of dawn was seen from the aeroplane, and signals now definitely became weak. Nothing further was received at G6OT until 6.45, when some signals were audible, but were so weak as to be unreadable. A watch was maintained until 8 a.m., but no further signals could be heard from the "Southern Cross."

In view of the fact that daylight was now full and that the Italian station had resumed working, it was considered futile to attempt any further reception.

On several occasions during the night efforts were made to obtain reports from American amateurs, but conditions were not satisfactory for this after midnight, and to date no information as to the reception of the "Southern Cross" in other countries has come to hand, although in view of the large num-

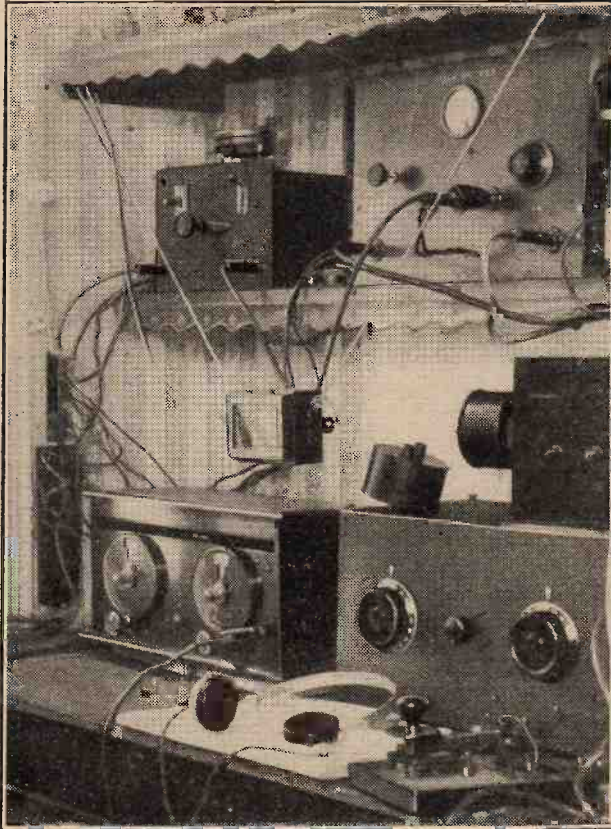

(Above) A corner of the receiving room of 6OT. On the left is a 20-metre set, while on the right is a standard G.E.C. short-wave receiver on which many of the "Southern Cross" signals were logged.

(Right) The 20-metre transmitter at 6OT intended for communication with American listeners to the "Southern Cross" signals.

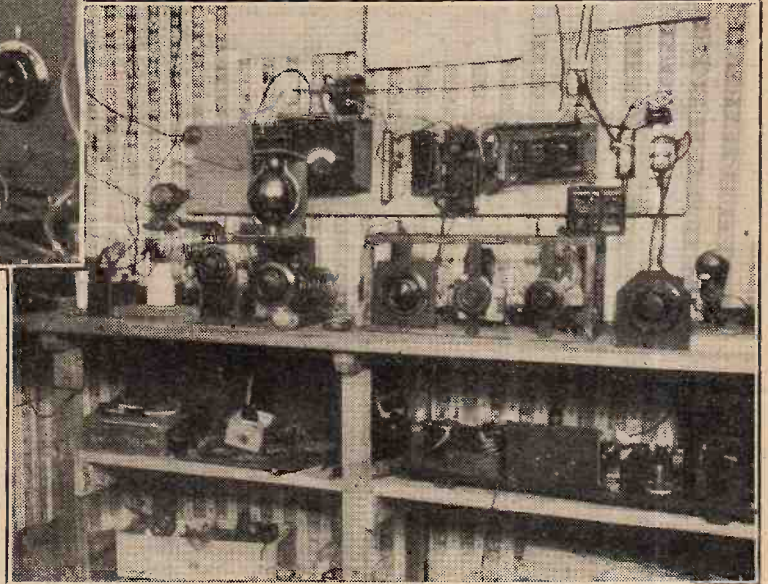

in the signal strength from the aeroplane itself.

When not actually transmitting a message or when the 600-metre transmitter was in use, the key of the 33-metre transmitter was short-circuited, thus leaving a continuous note enabling the receivers to keep in touch with the aeroplane. The note produced by VMZAB was of the tonic train character to be expected from the use of raw A.C. on the anodes. It was interesting to note that the pitch varied very considerably as the air speed of the machine varied on encountering "bumpy" patches. About this period also atmospheric interferences became noticeable, and as a combined result of this and the interference from IDO by 13.30 B.S.T. it became impossible to copy the messages.

A continuous watch was maintained during several hours of poor reception in spite of the pessimism naturally produced. Later on in the evening, however, conditions improved again, and great excitement was caused when IDO at last closed down.

By 12 midnight the strength had risen to such a value that

number of foreign stations who promised co-operation in this work, a very interesting mail is anxiously awaited.

In conclusion, the writers cannot refrain from commenting upon the magnificent way in which Mr. Stannage operated VMZAB throughout the trip. Scarcely a moment passed during the whole flight without his being "on the key" on one or more of the wavelengths employed. There can be no doubt of the confidence which must have been inspired in his companions by the knowledge that a great body of keen men were anxiously following the progress of this wonderful achievement.

WIRELESS
THEORY

SIMPLIFIED

By S. O. PEARSON,
B.Sc., A.M.I.E.E.

Part XXXV.—Self-capacity and Dielectric Losses in Coils.

(Continued from page 678 of previous issue.)

IT was pointed out in the previous section that dielectric losses could occur only in those parts of a circuit where electrostatic capacity is present. Capacity exists between any two conducting bodies separated by an insulating medium and manifests itself when a potential difference is applied between them. Therefore, in an ordinary tuning coil, capacity will exist between any one turn and the rest; that is to say, an inductive coil always possesses internal capacity or "self-capacity."

Equivalent Parallel Capacity.

If an alternating voltage is applied to the ends of a coil, and if the frequency of this voltage is gradually raised from a very low value to a very high value, it will be found that for the lower frequencies the coil behaves like a circuit with resistance and inductance, taking a lagging current and therefore having a positive reactance, but that after a certain value of frequency has been reached and passed it behaves like a circuit with resistance and capacity, taking a current which leads the voltage. In other words, at very high frequencies the coil acts as though it were a condenser, the resultant reactance being negative or "condensive."

This behaviour indicates that the actual coil, shown in Fig. 1(a), possessing self-capacity is equivalent to an imaginary coil with the same inductance value L , but having no internal capacity, connected in parallel with a condenser of capacity C_0 , as shown in Fig. 1(b). For such a circuit the current taken by the inductive branch decreases as the frequency is raised, whereas that taken by the condenser branch is directly proportional to the frequency; so that at low frequencies the current drawn from the source of supply is nearly all due to the upper branch, and is therefore a lagging one, whilst at high frequencies the condenser branch accounts for most of the current, so that the total current leads the voltage as regards phase angle. The angle of lag, or lead, as the case may be, is necessarily less than 90° , due to the presence of resistance.

If the coil of Fig. 1(a) and the circuit of Fig. 1(b) were each enclosed in a separate case with only the

terminals AB and A'B' respectively available, and if C_0 were given the proper value, it would be impossible to determine by ordinary electrical tests which case contained the actual coil. The value of C_0 which makes circuit (b) electrically equivalent to the actual coil is referred to as the self-capacity of the coil in so far as the numerical value is concerned. It is really the value of the equivalent parallel capacity which would have the same effect as the actual self-capacity.

The self-capacity of a coil is not of a simple nature like that of a condenser, because it is divided up and distributed over all parts of the coil; but for practical purposes it is necessary to express its effects in terms of a single concentrated capacity in parallel with the coil.

In a single-layer solenoid or coil wound on a cylindrical former, capacity exists not only between adjacent turns but between any one turn and each of the remainder; it will thus be realised what a complicated network of small condensers is represented by all the elements of internal capacity in the coil. But no matter to what extent the capacity is divided up, it still represents a store of electrostatic energy within the dielectrics in the neighbourhood of the turns when a potential difference exists between the ends of the coil. The value

of the equivalent parallel capacity C_0 depends on the voltage distribution over the length of the coil, and this in turn depends upon the frequency. For instance, if a steady D.C. voltage is applied between the ends of the coil the voltage per turn will obviously be the same throughout its length. But at high frequencies the voltage in any one turn is almost proportional to the magnetic flux linked with it; and since the greatest flux is linked with turns near the centre of the winding, it follows that the voltage per turn is greater near the centre than at the ends of the coil.

The voltage distribution along the coil changes with the frequency due to the presence of resistance. At very low frequencies resistance is the controlling factor and results in almost uniform distribution of voltage, but as the frequency is raised the reactance becomes more important relative to the resistance, the effects being greatest near the centre of the coil, and the voltage distributes itself accordingly. The net result is that a

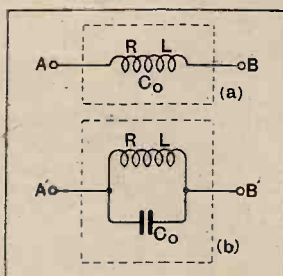

Fig. 1.—For convenience the self-capacity of a coil is expressed in terms of the capacity of an equivalent parallel condenser. As regards external voltage and current, the two circuits (a) and (b) are electrically equivalent.

Wireless Theory Simplified.—

change of frequency involves a corresponding (small) change in the stored energy in the electrostatic fields. Hence the self-capacity of a coil depends to a small extent on the frequency of the voltage applied. However, at high frequencies the resistance becomes negligible compared with the reactance, so that the voltage distribution and self-capacity can be assumed to be constant at radio frequencies.

Natural Wavelength of a Coil.

Suppose that a condenser of capacity C farads is connected across a coil whose inductance is L henrys, as shown at (a) in Fig. 2; then, on the assumption that there is no self-capacity in the coil, the frequency to which it is tuned would be calculated in the ordinary way from the

$$\text{formula } f = \frac{1}{2\pi\sqrt{LC}}$$

cycles per second; but actually, on account of the self-capacity C_0 in the coil, the combination is equivalent to that shown by the circuit of Fig. 2(b), and is therefore tuned to a somewhat lower

$$\text{frequency given by } f = \frac{1}{2\pi\sqrt{L(C+C_0)}} \text{ cycles per}$$

second. If the value of C is now gradually reduced the resonant frequency is correspondingly increased until, when C reaches zero, the frequency to which the coil

$$\text{is tuned becomes } f_0 = \frac{1}{2\pi\sqrt{LC_0}} \text{ cycles per second. This}$$

means that the coil alone is *tuned to resonance by its self-capacity*, and the particular frequency is referred to as the *natural frequency* of the coil, the corresponding wavelength being the *natural wavelength*.

The natural wavelength is sometimes difficult to determine in practice by direct measurement, because the high-frequency resistance at the natural frequency may be sufficiently large to render the resonance curve extremely flat, in spite of the high ratio of inductance to capacity. In practice the self-capacity is usually determined by finding the resonant frequencies for two or more known values of C and then finding C_0 by calculation.

Dielectric Losses in a Coil.

The insulating medium between any two turns of a coil consists of two or more dielectrics, namely, air, the insulating covering (if any) of the wire, and the material of which the former is made. Dielectric losses occur in the latter two.

Electrostatic lines of force are "conducted" through all solid dielectrics more easily than through air or a vacuum, and, expressed numerically, the degree to which a dielectric permits electrostatic lines of force to pass through it in comparison with a vacuum is called the *permittivity* or *dielectric constant* (previously known as specific inductive capacity) of the material. A definition

of permittivity was given in Part X, dealing with condensers and capacity.

For ebonite the permittivity is 3, and for bakelised fibre or paxolin tubes it ranges between 5 and 6. So in a coil wound on a cylindrical former the lines of electric force between turns will tend to follow the easiest paths and not necessarily the shortest ones. The coil-former itself allows a considerable number of lines of electrostatic force to pass within it from turn to turn, and Fig. 3 is given to indicate roughly how the electric field is disposed relative to the conductors in a single-layer tuning coil wound on an ordinary cylindrical former. At (a) the turns are closely wound so that consecutive turns are touching (the wire being covered) and at (b) they are spaced apart. It will be noted that in either case a large proportion of the electric field passes along inside the material of the coil-former, but that with the spaced winding the intensity of the field is greatly reduced.

The dielectric losses which occur at a given voltage and frequency depend on the quality of the insulating materials used, the intensity of the electric fields set up in them, and the volume of the dielectric which comes within the influence of the field. In designing a low-loss coil the dielectric losses can thus be reduced to a minimum by (a) using as little solid dielectric as possible where the field is most intense; (b) employing good material, such as high-grade ebonite for what solid dielectric is essential; and (c) spacing the turns.

As regards (a) the coil can be wound on a skeleton former or on a specially ribbed cylindrical former, the ribs serving to space the winding away from the cylinder itself. Special tubing with six or eight equally spaced ribs parallel to the axis is manufactured for this purpose. It should be remembered that the *magnetic* field has no direct effect on the insulating material. Spacing the turns was shown in the previous part to result in the lowering of the high-frequency resistance of the wire comprising the coil itself, and now we see that such a procedure has a twofold advantage.

With a view to the reduction of dielectric losses it is of fundamental importance that, in a coil intended for radio-frequency currents, the parts of the wire comprising the beginning and the end respectively of the winding should be kept as far apart as possible, because it is between the two ends that the greatest potential difference occurs. For a given voltage between two conductors the intensity of the electric field in the insulating medium between them is inversely proportional to their distance apart, and the power lost per cubic centimetre of dielectric is proportional to the square of the field strength.

It is thus clear that for reasonable efficiency the two ends of the winding should be well separated, and from this point of view the single-layer cylindrical coil is

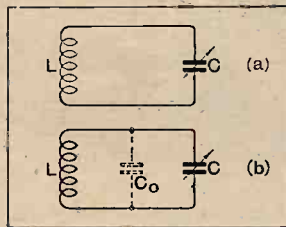

Fig. 2.—When a condenser is connected in parallel with a coil, the resonant frequency is given by

$$f_0 = \frac{1}{2\pi\sqrt{L(C+C_0)}} \text{ cycles per sec., where } C_0 = \text{self-capacity of coil and } C = \text{capacity of condenser in farads.}$$

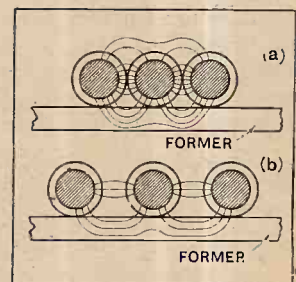

Fig. 3.—Diagrams showing approximately the distribution of the electrostatic lines of force between turns of a single-layer coil. (a) Closely wound coil. (b) Coil with spaced turns.

Wireless Theory Simplified.—

ideal. But apart from the electrical considerations, the actual dimensions, length and diameter, very often have to be taken into account in designing a tuning coil, by reason of the available space in the average set. For wavelengths below 600 metres or frequencies higher than 500 kilocycles per second a single-layer cylindrical coil can usually be made sufficiently compact without undue sacrifice of efficiency; but for the band of longer wavelengths used in broadcasting, namely 1,000 to 2,000 metres, a single-layer coil would be inconveniently large. For reasons which are obvious it is inadmissible to employ very thin wire on a small former as a means of obtaining the necessary number of turns in a single layer.

Multilayer Coils.

Having thus perforce to use wire whose diameter must not be less than a certain predetermined figure, the only alternative is to wind the coil with more than one layer, or to arrange the coils in groups wound in slots cut in a cylindrical former or in the ribs of a ribbed former of the type already mentioned and illustrated above.

There are one or two important points to be borne in mind in connection with multilayer coils. One of these is that a two-layer coil is possibly the worst type that could be constructed, because the first and the last turns lie almost as close together as it is possible to get them. Since the full voltage developed in the coil exists between these two turns the field strength in the dielectric separating them will be a maximum, with the result that both the self-capacity and the losses will be unduly large.

In order to obtain an efficient multilayer coil the voltage existing between any two adjacent turns in separate but consecutive layers should be a reasonably small fraction of the total voltage across the coil. The

greatest potential difference between adjacent turns obviously occurs between two turns at the ends of the layers (really the beginning of one layer and the end of the next as wound) and consequently it is better to employ a comparatively large number of fairly short layers rather than a few long layers. On the other hand, if the axial length or breadth of the coil is made too small the outer diameter becomes excessively large, especially if the layers are spaced.

In practice a compromise is struck between breadth and mean diameter to give a coil of reasonably small dimensions, the axial length of the innermost layer being made about half its diameter. A coil of this type can be made quite efficient if both the layers and the turns are spaced, using as little solid dielectric as possible.

If a coil has N layers, and if E is the voltage between the ends of the coil, the voltage between the end turns of a pair of consecutive layers will be $\frac{2E}{N}$, and since the self-capacities between consecutive pairs of adjacent

layers are all in series the self-capacity of the coil as a whole will be nearly inversely proportional to the square of the number of layers, i.e., to $\frac{1}{N^2}$.

A very widely used long-wave coil is the type where the winding is carried in slots on a ribbed cylindrical former. The slots are cut in the ribs and each carries a group of 10 or 20 turns. Although each group possesses considerable self-capacity on account of the wires being bunched together, the overall self-capacity of the coil and the consequent losses are reasonably small because the elements of self-capacity represented at each slot are all in series, the principle involved being the same as that of a multilayer coil.

(To be continued.)

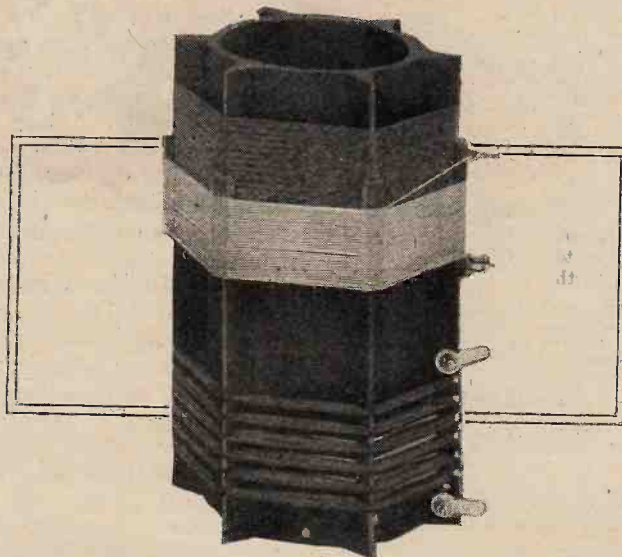

A typical "Wireless World" inductance of high efficiency.

The Acid Test.

Thirteen different types of loud speaker were tested behind a screen at last week's meeting of Slade Radio (Birmingham), members of the audience acting as a jury. A gramophone and special amplifier were used for the purpose of reproduction, the records consisting of orchestral, vocal and dance numbers. The results of the voting were interesting and instructive, and could be regarded as entirely impartial.

At a previous meeting Mr. A. C. Copey, of Messrs. L. McMichael, Ltd., gave an interesting talk, with demonstration, on super portables. Questions discussed included range and portability and the introduction of the screened grid valve. Two sets were demonstrated, the first comprising one S.G. detector and two L.F. with an Amplion B2 loud speaker unit, and the second two S.G. detectors and pentode with Celestion loud speaker. A number of stations were received at good strength, but it was noted that quality was largely dependent upon tuning skill.

CLUB NEWS.

The Society holds meetings every Thursday evening at 8 o'clock at the Parochial Hall, Broomfield Road, Slade Road, Erdington. All interested in wireless are welcome.
Hon. Secretary, 110, Hillaries Road, Gravelly Hill, Birmingham. ○○○○

Making a Screen Grid and Pentode Portable.

Diagrams and cardboard models explained in a fascinating manner a talk on correct needle-tracking given by Mr. G. W. Heath at a recent meeting of the Hackney Radio and Physical Society. The speaker gave many useful hints on the preservation of records, recommending the use of non-metallic needles and the careful cleaning and lubrication of the motor.
The construction of an efficient portable re-

ceiver comprising a screen grid H.F. stage and pentode output was described at a recent meeting of the Society by Mr. G. V. Colle. Mr. Colle showed how to obtain the advantage of a pentode output, at the same time keeping the anode current within reasonable limits.

The Society meets every Monday evening at the Electricity Showrooms, Lower Clapton Road, E.5, at 8 o'clock.

Hon. Secretary, Mr. G. E. Sandy, 4, Meadowway, Raynes Park, S.W. ○○○○

Television.

An interesting visit to the studios of the Baird Television Company in Long Acre was recently paid by members of the South Croydon and District Radio Society. The visitors were given every opportunity to examine the apparatus, and several members of the Society were "televised."

Hon. Secretary, Mr. E. L. Cumbers, 14, Campden Road, South Croydon.

Duplicating 5XX.

Dignified excitement is observable at Savoy Hill over the suggestion in last week's *Wireless World* that 5XX should be duplicated. Objections are raised, but this is natural, for the path of true broadcasting never did run smooth. It is feared, for example, that a suitable long wavelength would not be available, and that if the wavelength of a distant long-wave station, such as Moscow, were employed, the station in question would be unkind enough to boost up its power and cause jamming.

o o o

A Mere Bogey.

This is very distressing to contemplate, but I doubt whether a far-away transmitter like Moscow would trouble itself with the doings of Daventry, so long as its own transmissions were not upset.

o o o

No Alternative Programme.

The B.B.C.'s main argument, however, against the duplication of 5XX appears to be that the task would not be worth while. Admittedly, there are many communities scattered throughout the British Isles where the 5XX transmission alone gives satisfaction, and it follows that these people have no alternative programme. But are they worth considering?

o o o

The Ten-Shilling Sacrifice.

The more important question is whether, like their brethren under the masts at Brookmans Park, they pay ten shillings for a licence. The fact that they do, and that ten shillings represents as big a sacrifice in Wick as in Wigan, should guarantee the distant listener as good a service as possible.

The Postmaster-General conveys letters to Wick for the same fee as to Wigan; both towns receive equal service.

o o o

Paying for Average Service?

But, the B.B.C. would say, it is impossible for all listeners to be the same distance from the nearest broadcasting station. Variations in signal strength are inevitable, and the ten-shilling licence fee must be regarded as the cost of average service. If a man chooses to live at a greater distance from a broadcasting station he must be content with weaker signals.

o o o

A Graded Licence Scheme.

Yes, but should he be required to pay as much? Why not a graded licence scheme, the licensees being assessed, not according to financial standing, as in the case of income-tax, but in accordance with their distance from Brookmans Park or Sunny Slaitwhaite?

o o o

Flocking to the "Dead" Spots.

Within the service area we should pay our ten shillings cheerfully. Beyond that radius the P.M.G. might make a becoming reduction to seven and sixpence per licence. A nominal fee of only one shilling might be charged in the so-called "dead" areas, which would probably become Scotch colonies.



By Our Special Correspondent.

Broadcasting House.

Not so long ago one risked cold in the eye peering through the chinks of the Portland Place hoardings to note progress in the construction of "Broadcasting House." Secrecy is no longer possible, the steel framework having now reached the second floor.

The builders have plenty of time for their job, their contract allowing them until next summer—a floor a month!

o o o

Preparing for the Worst?

I hope the Electricity Commissioners are not anticipating trouble. In announcing that the new 132,000-volt overhead power lines are about to be energised in the Glasgow-Edinburgh-Dundee area and also in the Bedford and Luton neighbourhood, they state that it is not expected that there will be any interference with broadcast reception.

o o o

Sensible Leipzig.

Both in France and Germany the utmost care is taken to avoid "man-made static." I hear that Leipzig listeners can now enjoy their programmes undisturbed, the tramway authorities having equipped 800 cars with a new method of eliminating undesirable radiation.

o o o

Forthcoming Wavelength Changes.

A minor reshuffling of British broadcasting wavelengths will take place when

FUTURE FEATURES.	
National (261 and 1,554 metres).	
JULY 6TH.	Drumhead Service from Colchester.
JULY 8TH.	Opening of India House by His Majesty the King.
JULY 9TH.	"A Limehouse Night."
JULY 10TH.	"The Brass Bottle," a farcical play by F. Anstey.
JULY 11TH.	Eye-witness Account of the Test Match at Leeds.
London Regional.	
JULY 6TH.	Orchestral Concert from Eastbourne.
JULY 9TH.	"The Brass Bottle," a farcical play, by F. Anstey.
JULY 11TH.	Orchestral Concert of Music by Liza Lehmann.
JULY 12TH.	"Under Neapolitan Skies," music and songs of Southern Italy.
Midland Regional.	
JULY 7TH.	The "Ne'er-do-Wells," in comedy and vocal harmony, from Royal Leamington Spa.
North Regional (Manchester).	
JULY 11TH.	Eye-witness Account of the Test Match at Leeds.
Glasgow.	
JULY 6TH.	Children's Service, relayed from the Orphan Homes of Scotland, Bridge of Weir.
Belfast.	
JULY 11TH.	Irish Variety Programme.

the Northern Regional station comes into operation. As already reported in these columns, one of the twin stations at Moorside Edge will use 479.2 metres, the present wavelength of the Midland Regional (erstwhile 5GB). I now learn that the other transmitter will "poach" Aberdeen's wavelength of 301.5, leaving the Granite City to content itself with the national common wavelength of 288.5 metres.

Midland Regional will take Manchester's present wavelength, viz., 377 metres.

o o o

Musical Misgivings.

That offspring of music wedded to financial economy, viz., the new B.B.C. Symphony Orchestra, as it is to be called, is creating dubious feelings up and down the country, especially in those provincial areas which have hitherto possessed very good broadcast orchestras of their own.

o o o

A Plea from Manchester.

Birmingham's grief has already been given full rein; now Manchester has sent a deputation to Savoy Hill to plead with Sir John Reith for the retention of the Northern Wireless Orchestra. I am told that the "D.G." satisfied the deputation, stating that the Northern Wireless Orchestra would remain until the end of the year or be replaced by another orchestra.

o o o

The Substitute.

Needless to say, this other orchestra would be a portion of the B.B.C. Symphony Orchestra allotted on occasion for the service of Manchester listeners, but probably performing in a London studio. *Sic transit, etc.!*

o o o

Farewell to Jazz?

I have it from Philip Ridgeway, the B.B.C. revue producer, that the modern type of syncopation without melody is on the wane. In twenty years' time, however, we shall all be looking back at the 1930 music with the fondness that now marks our attitude to the songs of 1910.

Mr. Ridgeway ought to know, for he has been developing his prophetic faculties in the preparation of the last revue of his present series, "The Music Hall of 1950," to be given on July 5th.

o o o

Microphone at the Firing Point.

My paragraph last week on the forthcoming running commentary at Bisley contained a slip which I am glad to correct. There is, of course, no "Cup" in connection with this contest; the competitors shoot for "The King's Prize," a sum of £250 presented by His Majesty, to which the National Rifle Association adds a gold medal and gold badge, together with £1,000 divided amongst 399 otherwise unsuccessful competitors. Captain Ernest Robinson, who will give the commentary from the 1,000 yards firing point on July 19th, tells me that over a thousand competitors will be gathered from all parts of the Empire.

CORRESPONDENCE

The Editor does not hold himself responsible for the opinions of his correspondents.

Correspondence should be addressed to the Editor, "The Wireless World," Dorset House, Tudor Street, E.C.4, and must be accompanied by the writer's name and address.

EMPIRE BROADCASTING.

Sir,—Many of your readers will have read with interest the letter from Captain Ian Fraser, in *The Times* of June 15th, in which he makes an appeal for a "big step forward" to be taken in Empire broadcasting.

This letter should serve to bring home the importance of the project, but it is a pity that Captain Fraser should not make acknowledgement where it is due, having overlooked or ignored the fact that Empire broadcasting was first proposed by *The Wireless World*, and has only been brought to its present stage as a result of persistent efforts of *The Wireless World*. Even the term "Empire Broadcasting" was first employed in its pages. If Captain Fraser cares to look back over early issues he will find that most, if not all, of his proposals have already been made in *The Wireless World*, including the suggestion for local transmitters in the Colonies to relay the Home transmissions. I have to go back four years to the issue of July 14th, 1926, wherein you state:

"In comparatively few cases would it be possible for individual listeners to pick up the transmissions direct, but central receiving stations of high efficiency would have to be put up which would supply the programmes from the Mother Country for rebroadcasting from local transmitters." S. E. HARDY.

Banstead.

Sir,—I would like to express my appreciation of the news transmission from G5SW. At 10.50 p.m. local time last evening the whole of the news bulletin broadcast from Chelmsford came through and was received at good loud-speaker strength. The quality was excellent, every word being perfectly clear. To those living in remote parts of the Colonies the transmission of news at a reasonable hour is a great boon, and is some three or four days ahead of the daily paper. Calcutta transmissions are useless on account of Static. The usual transmissions of the National programme by Chelmsford is also received well, and in quality and strength is always superior to that from PHOH, which transmits at an earlier hour.

To hear Big Ben is always a thrill to those abroad, and if the time signal from this can be transmitted at a reasonable hour it will always be appreciated. May I suggest the present news transmission from G5SW should also give the local time. I shall never forget the first time I heard "Big Ben." It was a hot night and "Skeeters" were having their evening meal! Just as the deep notes of "Big Ben" came through, and with it a temporary vision of Parliament Square, London traffic and its lights, I was startled by the appearance of a porcupine which wandered in through the open door.

Also at that moment a leopard on the prowl outside gave its long guttural call.

Tezpur, Assam.

May 13th, 1930.

ERNEST J. NICHOLLS.

STENODE RADIOSTAT.

Sir,—I was much interested to read in your issue of May 21st Mr. Pearson's suggested explanation of the functioning of the "Stenode Radiostat." In common, no doubt, with others who are engaged in radio work, I have been eagerly awaiting some precise explanation of this system which apparently accomplishes a thing which the state of the art a few months ago would have condemned as impossible.

The first Press announcements with regard to the Radiostat seem to have been followed only by protracted and fruitless arguments as to the existence or non-existence of side bands. As Mr. Pearson points out, the system must be equally explicable in terms of a single modulated frequency or of side bands. There are certain points in Mr. Pearson's explanation, however, which are not quite clear to me. He points out that a

carrier plus two side bands are the equivalent of a single central carrier frequency of modulated amplitude. This is true enough; but he goes on to say that two frequencies, such as the carrier of the required station and the carrier of a station causing a heterodyne interference, have their equivalent in an oscillation whose amplitude is not only modulated but whose frequency is also modulated. This is not quite correct. If $\sin \omega_1 t$ represents one carrier and $\sin \omega_2 t$ the other we have as a standard trigonometrical relation:

$$\sin \omega_1 t + \sin \omega_2 t = 2 \cos \frac{(\omega_1 - \omega_2)t}{2} \cdot \sin \frac{(\omega_1 + \omega_2)t}{2}$$

the right-hand side representing the side bands produced by modulating a carrier whose frequency is the mean of the two original frequencies by a lower frequency equal to half the difference of these two frequencies. This indicates the production of a new and slightly different steady frequency but no frequency modulation.

In any case the interfering carrier frequency is by supposition at least as close to the required carrier frequency as the more outlying side bands of the required transmission, so the explanation of the Radiostat cannot rest solely in terms of selectivity. There must be some subtle effect which differentiates between the kind of beat effect produced between two steady unmodulated frequencies and the kind of beat effect produced by a pair of side bands and their associated carrier. Now in the original brief descriptions of the Radiostat and also in such of Dr. Robinson's patent specifications as I have been able to see a special point is made of a periodical reversal at a supersonic frequency (say, 20,000 cycles per second) of the phase of signal E.M.F.'s applied to the receiver. With such a system one can visualise the production of special effects; but our hopes of some fundamental new principle have now been shattered by Mr. Pearson's statement that the same results are obtained with nothing more original than an ultra-selective supersonic heterodyne with a tone corrector at the L.F. end to compensate for the attenuation of the outlying side-bands. But why does this not compensate equally for the beat note due to a heterodyning station? We still await a precise quantitative explanation.

At the moment the "Stenode Radiostat," like television a year or so ago, seems to enjoy a publicity which is in advance of the solid technical facts available.

Cookham Dean, Berks.

E. HOWARD ROBINSON.

WIRELESS RESEARCH AEROPLANES.

Sir,—In your issue of May 28th you had a paragraph giving credit to the Ferranti aeroplane for being the only machine used for radio research. In your issue of June 1st Messrs. Alfred Graham claimed that they have had an aeroplane engaged in research work for twelve months.

As there seems to be some competition for credit in this matter may I point out that the Marconi Company has possessed an aeroplane used exclusively for research and experimental work since 1920, and that its first aeroplane, a De Havilland D.H.6, was the first civil aeroplane to be registered for commercial use by the Air Ministry. It had the registration mark GE AAB, and did all the pioneer work in the early days in the commercial development of wireless telephony for civil aviation.

A Renault Avro, with the registration mark GE BAJ, succeeded the D.H.6, and at the present time the Marconi Company is using a "Bristol Fighter," with registration mark G EBIO for the development of short wave wireless telephone and telegraph apparatus, which is the latest phase in wireless for civil aviation purposes.

W. G. RICHARDS.

Marconi's Wireless Telegraph Company, Limited.

READERS

PROBLEMS



The Service is subject to the rules of the Department, which are printed below; these must be strictly enforced in the interest of readers themselves.

Charging H.T. Accumulators.

I am about to fit up a charging board so that my H.T. accumulator battery can be recharged from the D.C. mains by operation of a switch. Is it advisable to make provision for completely disconnecting the batteries from the receiver while they are on charge? To do so means a slight complication of the switching system, which I should like to avoid. F. G. C.

To be on the safe side, we recommend that there should be no metallic connection between set and batteries while charging is in process. We should point out that if this advice is not observed, it will be essential to fit a condenser in the earth lead in order to prevent "earthing" of the mains.

o o o o

Extra Tuned Aerial Circuit Causes Instability.

I have just added a capacity-coupled aerial tuner to my existing H.F.-det.-L.F. receiver, which was formerly quite stable over the whole of both medium and long wavebands. Now, unfortunately, it is hopelessly lacking in stability unless the H.F. valve filament is dimmed so much that amplification is negligible. Can you tell me what is likely to be wrong? W. H. R.

It seems that this trouble must be due to one of two causes. It may be that your receiver was originally stabilised by aerial loading, or that the coil in the extra circuit is so mounted that it is coupling with the anode circuit inductance. In either case, the remedy is to pay attention to the isolation of circuits, and, if nothing more can be done in this direction, to reduce

RULES.

- (1.) A query must be accompanied by a COUPON removed from the advertisement pages of the CURRENT ISSUE.
- (2.) Only one question (which must deal with a single specific point) can be answered. Letters must be concisely worded and headed "Information Department."
- (3.) Queries must be written on one side of the paper and diagrams drawn on a separate sheet. A self-addressed stamped envelope must be enclosed for postal reply.
- (4.) Designs or circuit diagrams for complete receivers or eliminators cannot ordinarily be given; under present-day conditions justice cannot be done to questions of this kind in the course of a letter.
- (5.) Practical wiring plans cannot be supplied or considered.
- (6.) Designs for components such as L.F. chokes, power transformers, complex coil assemblies, etc., cannot be supplied.
- (7.) Queries arising from the construction or operation of receivers must be confined to constructional sets described in "The Wireless World"; to standard manufactured receivers; or to "Kit" sets that have been reviewed.

"The Wireless World" Supplies a Free Service of Technical Information.

magnification by adjustment of the interval coupling. A receiver can hardly be considered as satisfactory unless it is inherently stable without taking into account the effect of aerial loading.

o o o o

Power Transformer Construction.

The power transformer described in "The Wireless World" of April 30th meets my needs, except that I wish to run a Westinghouse rectifier, Type A.3, for energising the field of a moving-coil loud speaker. If it is possible to add the necessary winding, will you please give me information as to the correct gauge of wire and number of turns? C. C. O.

It should be possible to accommodate an extra winding for this purpose; it may consist of 84 turns of No. 20 D.C.C. wire.

o o o o

Too Many Turns.

As far as reception of most stations is concerned, my det.-2 L.F. receiver seems to work much better with the earth lead entirely disconnected, although its sensitivity is always rather disappointing. Can you make a suggestion as to what is wrong?

All this applies to the medium broadcast waveband; results on the long waves are as good as one can expect from a receiver of this sort.

E. C. R.

We think it fairly certain that your aerial tuning inductance (it is assumed that the set has a directly coupled aerial) is too large, with the result that most of the stations on the broadcast waveband cannot be accurately tuned in unless capacity on your aerial is, in fact, almost completely removed by disconnecting the earth wire.

We advise you to try the effect of removing turns from the medium-wave coil, or, alternatively, to try the simpler expedient of connecting a fixed condenser of 0.0001 or 0.0002 mfd. in series. We take it that plug-in coils are not used, but, if they are, the remedy is to use a smaller coil for medium-wave reception.

A selection of queries of general interest is dealt with below, in some cases at greater length than would be possible in a letter.

For Greater Selectivity.

In the article describing the "Yachtsman's Three" (June 4th) it was recommended that a two-circuit aerial tuner should be used in cases where a fairly large aerial could be erected. Will you please suggest a suitable arrangement for this extra circuit, bearing in mind the fact that simplicity of operation is a factor to be considered?

W. R. B.

There is really very little to choose between the methods of coupling a tuned aerial circuit to its associated secondary; but, as you make a point of easy operation, we doubt if you could better the simple "auto-transformer" arrangement shown in Fig. 1. This employs fixed (or, per-

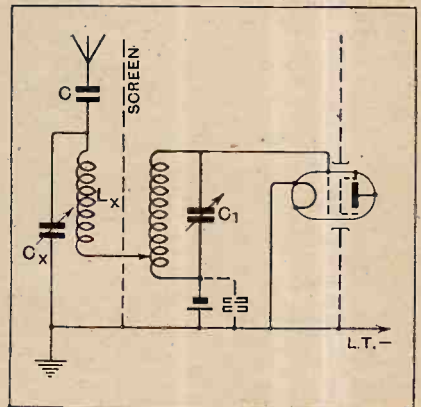

Fig. 1.—A two-circuit aerial tuner for the "Yachtsman's Three" receiver.

haps, semi-fixed) coupling, which, when once adjusted to a good average position, need not be touched again.

The grid coil as specified—but with perhaps four extra turns in each section to compensate for the removal of aerial capacity—will do for the secondary circuit: in the diagram the ends of the coil are lettered to correspond with the original circuit. Generally speaking, the tapping for the loaded aerial connection should be joined to a point about five turns above the end marked e.

Condenser C is the original series aerial capacity, and Cx is the extra aerial tuning condenser, which may have a capacity of 0.0005 mfd. Lx is the aerial loading coil, of which the inductance will naturally depend to an extent on aerial constants.

As the grid bias cell for the H.F. valve is now included in the aerial oscillatory circuit, it would be wise to shunt it with a large condenser (as shown in dotted lines), or else to replace it as soon as it shows signs of developing a high internal resistance with age.

Sense of Reaction Windings.

I seem to remember having read in "The Wireless World" some time ago that the correct sense of the reaction winding can be determined without the need for making a test, the rule being that imagining oscillatory currents to originate on grid and plate of the valve, they should flow through the coupled grid and plate coils in opposite directions. Now, I know, from actual experience that this is correct, but it can also be demonstrated that reaction winding sense is also correct in a Reinartz type of circuit, where the feed-back coil is in the same direction as the winding, being merely an extension of it. Will you please explain?

T. C. G.

We think that you have overlooked the fact that the sense of magnetic coupling is

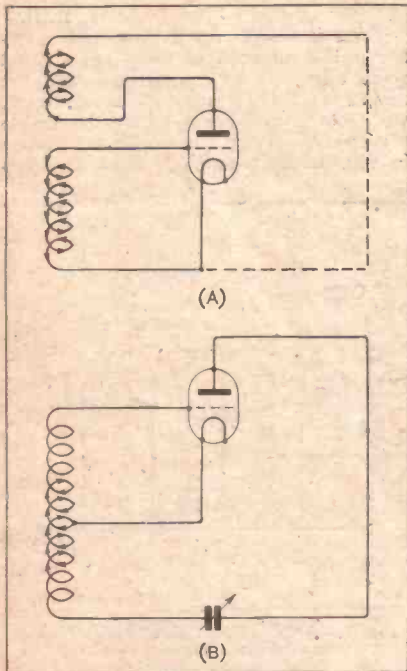

Fig. 2.—Diagram A shows the direction of grid and plate windings for production of self-oscillation, while diagram B shows that the two sections of a Reinartz coil are in the same sense.

not entirely a matter of direction of winding of the coils; by reversing the connections to either one coil the same effect is produced as when the direction of winding of one of them is changed.

Regarding the Reinartz type of circuit, we think that the matter will be made clear by a consideration of the accompanying diagram (Fig. 2). Circuit A is that usually drawn to demonstrate the rule you quote; it shows the conditions necessary for producing regeneration. Currents flowing outward from grid and plate respectively are passed through the coils in opposite directions. In the Reinartz single-coil circuit (diagram B) it may be considered that the connections to the reaction winding (lower section of the coil) have been reversed by joining the plate via the reaction feed condenser to the end of the

reaction coil remote from the negative filament connection, which is, as always, the starting or finishing point of the circuit. The arrows show that the sense of coupling is the same as in circuit A.

o o o o

A Resistance Filter.

Is there any reason why a wire-wound resistance of suitable value should not be used in place of a choke in a loud speaker filter feed device?

H. H. C.

It is possible to do this, but the scheme is hardly practicable. If a resistance of sufficiently high value were inserted in series with the anode of the output valve an excessively high voltage drop would be produced. In compensation, a considerable excess pressure would have to be provided.

o o o o

Easily Modified.

Will you please tell me if the circuit arrangement of the "Ideal Home Receiver," described in your issue of March 19th, is likely to lend itself for use with indirectly heated A.C. valves, and, of course, H.T. current from an eliminator?

C. H. F.

A receiver of this kind, with single medium-gain H.F. and L.F. stages, is always easy to modify in this way, and no special difficulties should be encountered.

The alterations involved will be mainly confined to the cathode circuits, but we should add the warning that in order to attain anything like the full magnification obtainable from most A.C. screen-grid valves, it would be advisable completely to screen the components associated with the H.F. intervalve coupling.

o o o o

Detector-Amplifier Conversion.

For my proposed H.F.-det.-L.F. three-valve receiver I am thinking of using a 7:1 ratio L.F. transformer. Components of this sort are, as you know, designed essentially for following a grid detector. Is it not a fact that when the detector is converted into an L.F. amplifier for gramophone reproduction, its impedance will go up considerably, and, in consequence, quality will not be so good as when the set is used for wireless reception?

Do you think that my fears are well grounded?

S. E. M.

Provided that your 7:1 ratio transformer is of good design, we do not consider that you need be apprehensive. While it is a fact that valve impedance will be higher when its grid is negatively biased for amplification than when it is acting as a grid rectifier, this rise can, if necessary, be offset to a certain extent by making an appropriate increase in anode voltage. In any case, if you decide to use a valve of about 12,000 ohms rated impedance as a detector—the modern tendency is to do so—there is no reason why bass reproduction of gramophone records should not be entirely adequate; the high step-up ratio of the proposed transformer may be helpful in providing extra magnification, which might be needed if your pick-up is insensitive.

Out of Step.

The first tuning condenser of my "New Kilo-Mag Four" receiver shows a considerably higher dial reading than the others, which are fairly well in step over both wavebands. Although this is not a very serious matter, I always find it easier to memorise the tuning adjustments corresponding to various stations when all condenser readings are similar. Will you please tell me how to put matters right?

E. F. L.

The most obvious suggestion to make is that you should remove a few turns from both medium- and long-wave grid windings. By doing this carefully it should be possible to arrange matters so that the dials are fairly closely in step: the adjustment should preferably be made when the set is tuned to a station at about the middle of the frequency band.

Again, it is possible that aerial coupling is unnecessarily "tight," with the result that an undue proportion of the aerial capacity is being transferred to the grid coil. Accordingly, it might be worth while to try the effect of moving the aerial tappings nearer the earthed ends of the windings.

Before making any alterations you should assure yourself that the input coil connections are exactly as described; cases have come to our notice where the aerial connections have been made to points near the "grid" ends of the windings.

FOREIGN BROADCAST GUIDE.**ROME (1RO)**

(Italy).

Geographical Position: 41° 54' N. 12° 29' E.
Approximate air line from London: 890 miles.

Wavelength: 441 m. Frequency: 680 kc.
Power: 50 kW.

Time: * Central European (one hour in advance of G.M.T.).

* B.S.T. coincides with C.E.T.

Standard Daily Transmissions.

08.15 and 11.00 B.S.T. News bulletin;
10.00-10.45 concert (Sun.); 13.00 news and concert; 16.00 concert (Sun.); 17.30 Time signal—(a series of nine dots and one dash, high-pitched note) followed by concert; 20.00 news, weather, etc.; 21.00 main evening programme (studio concert or opera).

Rome frequently exchanges broadcasts with Naples.

Female announcer only. Call: *Ente Italiano Audizioni Radiofoniche, Stazione di Roma*. Abbreviated, between items to: *Eh-yah (E.I.A.R.) Radio Roma*.

Opening signal: High-pitched tuning note.

Closes down with Italian National Anthem (*Marcia Reale*) and Fascist Hymn (*Giovinetta*) and words: *Fine della trasmissione, Buona notte a tutti*.

Receivers for Sale.—Contd.

McMICHAEL Portable Four, as new; £12.—Florin, 84, Lansdowne Av., Leigh-on-Sea, Essex. [9832]
MARCONIPHONE Portable, new condition, £12; screened 4-valve, £10; S.W. set, £10; new 5-valve cabinet set, £15; Marconi type 61, £20; moving coil speaker, £3; numerous components.—2a, Salisbury Rd., Seven Kings, Essex. [9886]
PORTABLE 5-valve, new; sell £6/10, cost £8/8.—C. P. G., Lynette Av., South Side, Clapham. [9885]
COMPULSORY, regardless of cost.—Selector cabinet, portable, mahogany, £16/10; McMichael transportable four, £14; Ormond portable five, £7; Pandona standard five, £8/10.—BM/MF3H, London, W.1. [9880]

ACCUMULATORS—BATTERIES.

WET H.T. Replacements.—Sacs (capped or uncapped), highest grade, No. 1, 10d. per doz.; No. 2, 1/9 per doz.—See below.
ZINCS—Best quality (wired), No. 1, 8d. per doz.; No. 2, 9d. per doz.; orders valued 5/- carriage paid, otherwise 6d. for postage.—British Battery Co., Clarendon Rd., Watford, Herts. [0253]

ACCUMULATOR HIRE.

DON'T Buy Accumulators or Dry Batteries, join our C.A.V. low- and high-tension accumulator hire service, the largest and best in London; better and cheaper reception with no trouble; regular deliveries within 12 miles of Charing Cross; no deposit, payment on each delivery or by quarterly subscription; over 10,000 satisfied users; explanatory folder post free; phone or write to-day.—Radio Service (London), Ltd., 105, Torriano Av., N.W.5. Phone: North 0623-4-5. [8751]

CHARGERS AND ELIMINATORS.

TANTALUM and **Lionium** for A.C. Rectifiers; for inexpensive chargers; blue prints for H.T. and L.T., 1/- each; Lionium electrodes, 2-5 and 5-8 amps.—Blackwells Metallurgical Works, Ltd., Garston, Liverpool. [8298]

SAVAGE Transformers and Chokes.

STOCKTAKING—The following new transformers are for sale owing to alteration of models: 22T20, 14T21, 12T22, and 5T23; also 34G and C28G chokes, all by Savage, of Bishopsgate.—Apply to Faraday, 8, Bridewell Place, Ludgate Circus, E.C.4. [9731]

PHILIPSON'S Safety High Tension Supply Units for A.C. and D.C. Mains, 200-250 volts 40-60 cycles, also 230 volts 25 cycles.

10/- Down and Small Monthly Payments Secures the Finest H.T. Supply Available.

PHILIPSON'S Safety H.T. Units are Guaranteed for 12 Months Against All Defects.

ALL Models Sold on 7 Days' Approval to Ensure Complete Satisfaction.

PHILIPSON'S Safety H.T. Units are the Cheapest to Install and the Cheapest to Run; £1/17/6 to £6.

WRITE for Our Booklet "Radio Power," which gives illustrations and full particulars.

PHILIPSON'S Safety Loud Speaker Output Filters for All Receivers, power valve, or Pentode; a remarkable output filter at a very low price; 16/6.

PHILIPSON and Co., Ltd., Radio Engineers, Astley Bridge, Bolton. Phone: 2038 Bolton. [0318]

ACVOKE L.T. Charger, rotary, operates on 220v. D.C., and provides 25v. 10 amps., complete with charging board, meters, etc.: cost over £30, will accept £10, or offer.—Norton, High St., Porlock, Somerset. [9783]

CHESTER BROS.—All types of mains transformers and chokes to any specification.—Chester Bros., 244, Dalston Lane, London, E.8. [9798]

ZAMPA H.T. Eliminator Kit, comprising rectifying unit (incorporating transformer, condensers, Westinghouse H.T.3), necessary condensers, choke, terminals, baseboard, etc., output 120 volts at 20 ma.; complete 45/-; seven days' approval against cash; other Zampa kits and transformers on request.—Mic Wireless Co., Market St., Wellingborough. [9797]

POWER Unit, A.C., output 200v. 50 m.a., and 6v. with power amplifier (3v.); £9/10, only tested, cost £13/10; demonstration.—Grangewood 1806. 632, Barking Rd., Plaistow, E.13. [9853]

EKCO Model I.V.20, 200-250 D.C., brand new; 30/-.—Bevan, 18, Clarendon Villas, Hove. [9833]

TRANSFORMERS—Ready Power, London.—Transformers and chokes for eliminators and chargers; the best and cheapest British made, list free.—Lallemand, 5, Charles St. (Hatton Garden), Holborn, London, E.C.1. [9831]

PHILIPS Charger (200 A.C.), L.T., 1.3 amps., H.T. 100 m.a.; cost £5/10, sell £2; as new.—Below.

RADIELLE Model R.K. Eliminator (200-250 A.C.), output 400v. 60 m.a., and 2 variable tappings, cost £13/15, sell £5/10; brand new, bargain.—Priestley, 74, Aberdeen Rd., Highbury, London, N.5. [9836]

Make Lotus
Coils & Condensers
your choice!

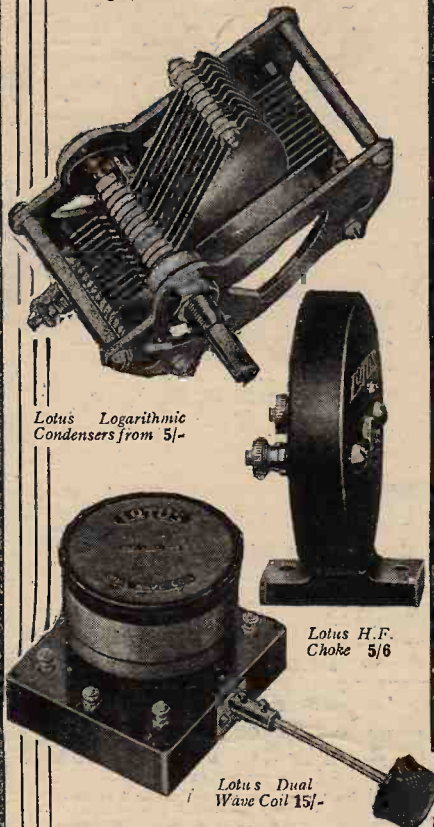

Illustrated here is the Lotus Logarithmic Condenser which is available in all capacities. These Condensers are truly logarithmic and have chemically cleaned brass vanes and end plate. The Lotus H.F. Choke is equally suitable for both reaction circuits and parallel feed H.F. circuits. Lotus Dual Wave Coils embody in one unit tuning and reaction coils, and serve the same purpose as the four coils which were previously required.

Write for full range of Lotus Components and Catalogue.

LOTUS COMPONENTS

Garnett, Whiteley & Co., Ltd.,
Lotus Works, Mill Lane,
Liverpool.

Chargers and Eliminators.—Contd.

H.T. Oldham Trickle Charger, Westinghouse, 240v. A.C., perfect condition, no faults; genuine bargain, 35/-.—21, Randall Av., London, N.W.2. [9868]

CLIMAX H.T. Eliminator, 220v. A.C., 50 milliamps at 150v., 10 tappings; £3.—A. Crozier, "Balmoral," Fulwood Hall Lane, Preston. [9888]

SAVAGE'S Specialise in Wireless Power from the Mains; reliable apparatus at reasonable prices.

SAVAGE'S—Transformer laminations and Bakelite bobbins; intending home constructors should write for list.

SAVAGE'S—Reliable smoothing condensers, 1,500 volt D.C. test, 1 mid., 2/-; 2 mid., 3/-; 4 mid., 5/3; 500 volt. D.C. test, 1 mid., 1/6; 2 mid., 2/3; 4 mid., 3/9.

SAVAGE'S—Super smoothing and output chokes, many types available; write for list.

SAVAGE'S—Mains transformer for Westinghouse H.T.4 unit, with additional winding, 4 volts centre tapped 3 amps, 23/-; transformers for other Westinghouse units available.

SAVAGE'S—Mains equipment for new Foreign Listeners. Four, transformer N.F.L.4, 33/-; smoothing choke, C32G, 20/-; output choke C30, 20/-.

SAVAGE'S—Mains transformer for Power Pentode Two transformer, P.P.2, 33/-; output choke, L.C. 36P.G., 19/6; smoothing choke, L.C.36G, 18/-.

SAVAGE'S—Mains transformer B.T.4, 500-0-500 volts, 120 m amps, 7½ volts 3 amps, 6 volts 3 amps, 4 volts 2 amps, 4 volts 1 amp, 4 volts 1 amp, all centre tapped, specially developed for automatic bias; 57/6.

SAVAGE'S—Mains transformers and power chokes are carefully and individually constructed from first class materials, with an exceptionally generous margin of safety.

SAVAGE'S, 146, Bishopsgate, London, E.C.2. Phone: Bishopsgate 6998. [9165]

PHILIPS' A.C. All-mains, unpacked, list price £23, accept £10/10; Ekco eliminator, £9/15 model, D.C., £4.—Rogers, 92, Barry Rd., Dulwich. [9866]

CABINETS.

CABINETS for All Requirements.—F. W. Ramsey, 63, Shaftesbury St., London, N.1. Clerkenwell 7139. [9736]

DIGBY'S Cabinets.—Table models in solid oak and mahogany; from 11/6 to 71/-.

DIGBY'S Cabinets, fitted with Radiou or Resiston ebonite if required.

DIGBY'S Cabinets.—Pedestal model, with separate battery components; from 56/- to £12.

DIGBY'S Cabinets Made to Customers' Own Designs.

DIGBY'S Cabinets.—Write for new 16-page art catalogue.—F. Digby, 9, The Oval, Hackney Rd., E.2. Phone: Bishopsgate 6458. [0128]

COILS, TRANSFORMERS, ETC.

TRANSFORMERS and Chokes for Battery Eliminators.—Chester Bros., 244, Dalston Lane, London, E.8. [9706]

BERCLIF Coils, the standard of excellence, for all "Wireless World" receivers; latest lists post free; trade supplied, all quantities.—Simmonds Bros., Shireland Rd., Smethwick. [8735]

600 and 1,000 Ohms Decoupling Resistances, specified for the largest and most important "Wireless World" receivers; 1/6 each, post free.—Groves Brothers, St. Mary's Place, Shrewsbury. [9864]

DYNAMOS, ETC.

NEWTON Motor Generator, comprising 230v. 50-cycle motor and starter, direct coupled to D.C. generator (volts 16/330/8) (amps. 4.5/1.5/4.5), new condition; £25.—Below.

M.L. Motor Generator, input 230v. A.C., output 350v. D.C. 80 m.a., 6v. 3a., H.T. and L.T. smoothing equipment, almost new; £12/10.—Below.

E.P.E. Rotary Converter, input 100 v. D.C., output 500v. D.C., 500 m.a.; £6.—Franks, 42a, St. George's St., London, E.1. Phone: Royal 8546. [9889]

GRAMOPHONES, PICK-UPS, ETC.

B.T.H. Latest Type Pick-up and Arm; cost 45/-, sell 25s., brand new.—Priestley, 74, Aberdeen Rd., Highbury, London, N.5. [9834]

BURNEDEPT Pick-up, new; £2, or offer.—Thornely, 13, Philbeach Gardens, S.W.5. [9844]

LOUD-SPEAKERS.

BAKER'S ELHURST RADIO 36-page Booklet. "Sound Advice is Yours for the Asking"; write now for new edition; see displayed advertisement on page 12. [0231]

AMPLION Lion, new condition, chassis only; £2/10.—Raymond Amis, 29, Maybank Rd., South Woodford, Essex. [9824]

Caution

Loud-Speakers.—Contd.

EPOCH Moving Coil Speakers are Masterpieces, designed and produced by master engineers.

EPOCH Moving Coil Speakers are the Standard by which other Speakers are Compared.

EPOCH Moving Coil Speakers are in Use in Many Editorial Offices.

EPOCH Moving Coil Speakers are in Use in Several Famous Laboratories.

EPOCH Moving Coil Speakers are in Use in Many Broadcasting Stations.

EPOCH Moving Coil Speakers are in Use by Most Prominent Musicians.

EPOCH Moving Coil Speakers Bring Unbounded Joy to Thousands upon Thousands of Homes.

EPOCH Moving Coil Speakers, the only speakers that give clear, uncoloured reproduction.

EPOCH Moving Coil Speakers do Render Speech Perfectly and Music Correctly.

EPOCH Moving Coil Speakers Provide the Perfect Illusion of the Artist's Presence.

EPOCH Moving Coil Speakers Represent the Finest Intrinsic Value Ever Offered.

EPOCH Moving Coil Speakers are Guaranteed for a Year, but last for ever.

EPOCH Moving Coil Speakers Bring the Grand Concert out of the Most Modest Set.

EPOCH—You can hear a hundred moving coil speakers, but Epoch is different.

EPOCH—If you own the best set, only by Epoch can you confirm it.

EPOCH—Away with the tin can and cracked banjo reproduction, and install an Epoch.

EPOCH—Away with the drumminess, droniness, and huskiness of the average moving coil speakers.

EPOCH—The clearest, sharpest, cleanest reproduction—a marvel of accuracy and beauty.

EPOCH Moving Coil Speaker Models from £2/10 to £30.

EPOCH Moving Coil Speakers.—Models for every requirement and taste.

EPOCH Permanent Magnet Moving Coil Speakers.—Nine models from £3/15.

EPOCH Permanent Magnet Moving Coil Speakers Require no Mains or Batteries.

EPOCH Permanent Magnet Speakers are more Sensitive than most Energised Moving Coil Speakers.

EPOCH Energised Models are the Finest ever put on the Market.

EPOCH Super Cinema Speaker has Created the Biggest Sensation for Many Years.

EPOCH Super Cinema Model is many times as Sensitive as the so-called Supers.

EPOCH Super Cinema Speakers give Enormous Volume from a 1-watt Amplifier.

EPOCH Super Cinema Speakers are used on many 100-watt Amplifiers and never "rattle."

EPOCH Super Cinema Model is Standard on several Talkie Equipments.

EPOCH Super Cinema Model is already in use in over 200 Cinemas.

EPOCH Super Cinema are the only Moving Coil Speakers used in Large Theatres, unaided.

EPOCH Super Cinema Speakers provide alone the Upper as well as the Lower Register.

EPOCH—Other Moving Coil Speakers require the help of exponential horns to provide depth.

EPOCH—A list of many prominent cinemas using the Speakers supplied on request.

EPOCH Speakers are not Made of Tin or Aluminium Stampings, but are sound, solid, engineering jobs.

EPOCH Heartily Invite Comparison, on all counts, with any make, regardless of price or claims.

EPOCH—Don't accept our quality claims without verification, but don't accept any other maker's either.

EPOCH—Order one on 7 days' approval, and test with a switch-over; the only real test.

EPOCH Moving Coil Speakers may be heard in our Demonstration Room Daily.

EPOCH—Our demonstration room is in the heart of London.

EPOCH—Its accessibility has been studied for the convenience of callers.

EPOCH—If you cannot call, write for booklet W.S.3, and approval terms.

EPOCH RADIO MANUFACTURING Co., Ltd., Farringdon Av. (near Ludgate and Holborn Circus). Phone: Central 1971. [8983]

METAL CABINETS

for all Wireless World sets from **22/6**. Aluminium screening boxes, all sizes, to order. Standard size from stock, 6x6x6½, price **4/-** each.

W. H. PARKER, Sheetmetal Workers,
Back Autumn Terrace, Leeds Tel. 52859.

Electrically sealed

METAL CABINETS

Complete with Base for 1930 Everyman Four, New Kilomag Four, and W.W. Record III. Jacobean Finish.

TERMS: CASH WITH ORDER Price **57/6**.

RIGBY & WOOLFENDEN, SHEET METAL WORKERS,
MILNROW RD., ROCHDALE.

REPAIRS

Any make of L.F. Transformer, Loudspeaker or headphones repaired and dispatched within **48 HOURS—TWELVE MONTHS' GUARANTEE** with each repair. **4/-** Post Free.

Terms to Trade.

TRANSFORMER REPAIR CO.,
Dept. W.,
953, Garrett Lane, Tooting, London, S.W.17

"LONDONA" PERMANENT MAGNET MOVING COIL LOUDSPEAKER

As described in "The Wireless World", Jan. 15, 1930.

No Field Coil to energise. High Resistance Coil in 1½ mm. gap.

£5 - 7 - 6

Write or call for full details.

A. M. E. Sherwood, 66, Hatton Garden, London, E.C.1

EXACT TUNERS

250 to 2,000 metres.

No further coils are required, tuning is as simple as A.B.C. see "Wireless World" January 25th: "We can strongly recommend these tuners." Send postcard for particulars and Circuits FREE to

THE EXACT MANUFACTURING CO.
Croft Works, Priory Place, COVENTRY.

BONA FIDE TRADERS' GUIDE.

Send for our comprehensive Illustrated List. QUICK SERVICE. QUICK SERVICE.

THE QUALITY HOUSE.

PERSEUS MFG. CO., LTD. (Dept. W.W.),
BRANSTONE RD., BURTON-ON-TRENT

POWER CHOKES

75 only, Power Chokes Silk Wire wound, heavy Core, 30 Henries, a production of the B.T.H.

F. W. Jolly,
410-416, Aston Lane,
Witton, Birmingham. POST FREE

10/6

"TILTRACK"

Registered Trade Mark

Patent STEEL STORES System

For the Wireless Experimenter, Factory, Factor and Retailer.

Full Particulars from Sole Manufacturer and Patentee:—
BERTRAM THOMAS, Worsley Street, Hulme, MANCHESTER.

Loud-Speakers.—Contd.

GENUINE Bargains in Loud Speakers. Marconiphone moving coil, mahogany cabinet (original type), A.C., with rectifier less valve; listed at £17/17, for £8.

AMPLION Lion L.C. 450 Oak Floor Cabinet, only slightly shop soiled; £6/5.

TRUVOX Mahogany Cabinet Speaker, listed at £7, case only slightly shop soiled; for £4/15.

GECOPHONE Stork Speaker, very handsome, perfect, new condition; listed £4/10, for £3.—Fairbairn, Ltd., 181, High St., Ayr. [9862]

LARGE Amplion Lion Chassis, £3; Amplion public address loud-speaker, type P.S.1, £3.—H. Harding, Treve Cottage, Ebbw Vale. [9849]

STIRLING (Baby), splendid condition, beautiful tone: £1/5.—Phone: King, Central 4000. [9846]

GAMBRELL Novotone, brand new, makers' guarantee; £3, offer—3, Gopsall St., N.1. [9891]

VALVES.

AMPLIFIER Valve.—If you require power you cannot do better than one of these:—

FILAMENT Volts 6, plate volts 400 (maximum), grid bias 84 volts (approx.), impedance 800 ohms, amplification factor 3.8, mutual conductance 4.35 m.a./volts; price £5/10; see article "The Wireless World," 24th July, 1929, then send to North London Valve Co., Ltd., 22½, Cazenove Rd., Stoke Newington, London, N.16. [9812]

PX.4, 10/-; P625A, 8/-; M.H.L.4, 10/-; L.S.6A, 18/-; U5, 10/-; all in new (original boxes).—Priestley, 74, Aberdeen Rd., Highbury, London, N.5. [9835]

COMPONENTS, ETC., FOR SALE.

BELLING-LEE Panel Fittings are designed to give an expert finish to any home-constructed set; catalogue post free.—Belling and Lee, Ltd., Queensway Works, Ponders End, Middlesex. [0018]

COMPONENTS Lent on Hire.—Details from Alexander Black, Wireless Doctor, 55, Ebury St., S.W.1. Sloane 1655. [0329]

SOLDER, specially prepared for radio joints, 2ft. strip; 6d., post free.—C. O. Pattison, 548, Shields Rd., Newcastle-on-Tyne. [9716]

AMAZING Bargains, amateur's surplus.—Transformers, condensers, drum dials, valves, etc., list post free; new Ferranti trickle charger, 200-240 A.C., £1/10.—Raymond Amis, 29, Maybank Rd., South Woodford, Essex. [9825]

MARCONI Pick-up, latest type, £2; Philips 5 guinea cone speaker, £2; Garrard D.S. gramophone motor, 32/6; No. 10A Ormond cone and chassis, 13/-; Dimic 1A and base, 4/-; Tunewell, D/E coil, 5/-; Watmel, Lewcos, Lotus, 7/-; Cosmos Anap broadcast, with base, 5/-; Wearite Titian coil, 7/6; Talisman, 4/6; moving coil, 2in., 2,000 T.C.T., 5/-; pair Marco S.M. dials, 5/6; A.C./H.L., 7/6; A.C./S.G., 12/6; B.T.H. 1-1 transformer, 7/-; Brown Vee unit, 12/6; Ohmax binoc. choke, 4/-; genuine, as new.—G. A. Ryall, 182, Kennington Rd., London. [9851]

RETAILERS' Bankrupt Stock of New Goods, all genuine: Cossor L.F. transformers, 13/-; Mullard Permacore, 13/-; Polar Ideal variable condensers, 0.0005, 7/-, slow motion; Philips 506 rectifier valves, for H.T., 14/-; Philips 328 and 451 valves, for L.T., 7/-; Geophone transformers, 2-1, 6/6; portable turntables, 2/-; Graham Farish resistances, carry 10 m.a., 2, 3, 4, 5, and 30, 40, 100, 250, 500, thousand ohms, suitable for decoupling, 1/6 each; Mullard grid leaks, 0.25, and 2 meg., 9d. each; Ediswan vacuum anode resistances, carry 1 m.a. at 180v., 30, and 250, thousand ohms, 9d.—G. A. Ryall, 182, Kennington Rd., London. [9850]

AMATEUR'S Surplus—Valves, coils, transformers, amplifier, etc., etc.: cheap; stamp for list.—BM/RDRG, London, W.C.1. [9845]

DF.A.7, new and unused, 12/6; wanted, A.C. volt-meter.—H. Claricot, 66, Archery Rd., S.E.9. [9843]

WEARITE Coils, "Wireless World" hit set, 25/-; Mazda 215 S.G., 15/-; Utility mite condensers, 0.0005 and 0.0003, slow motion dials, 6/- each; 2 T.C.C. 0.1 mfd, 1/3 each; 2 Wearite 600 ohms, decoupling, 1/- each; Irganic 50 ohm rheostat, 1/6; Aermonic S.G. holder, 6d.—W. Fisher, 71, Seven Sisters Rd., Holloway, N.7. [9842]

OFFERS.—Dixonometer, 6 multipliers, magnetic charger, 110v., 6v. 6a., Mo. m.a., 0-100, by Weston, 4-valve short wave receiver, in cabinet, Australia and America telephony.—Ivins, Henlow Camp, Beds. [9841]

PARMEKO Mains Filament Transformer, 4 volt 4 amp., 6 volt 0.25 amp., 18/6; M.S.4, 16/-; P625, 8/6; wanted, electric gramophone motor.—Gleed, Optician, Raynes Park. [9837]

RADIO HOUSE, HUDDERSFIELD, issues the Reliability Wireless Guide, which will be sent post free upon request by Messrs. J. H. Taylor and Co., 15, Macaulay St., Huddersfield. [7823]

PART Exchange.—See our advertisement under Receivers for Sale.—Scientific Development Co., 57, Guildhall St., Preston. [0028]

**Specified
for the
"BAND PASS"
FOUR.
MAGNUM
ALUMINIUM
SCREENING BOXES**

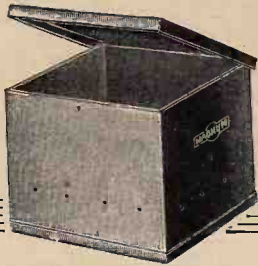

Similar to illustration, size 4½" x 6½" x 6"
Frosted finish.

PRICE 5/- EACH

We specialise in the "BAND PASS" FOUR and can supply as a constructional kit, ready wired and tested or parts separately. Full particulars and interesting literature, free on request.

**BURNE-JONES
AND COMPANY LIMITED,**

"Magnum" House, 295 Boro' High Street, London, S.E.1.
Telephones: Hop 6257 & 6258.

"ALL MAINS"

suit any electric supply, A.C. or D.C.

NO AERIAL OR EARTH
H.T. BATTERIES
L.T. ACCUMULATORS
HUM-TROUBLE.

4-VALVE SCREENED GRID MODEL.



Complete with good loud speaker, will receive principal British and Foreign Stations (long and short waves), mounted on turntable **£18-18-0**
Demonstrated in your home without **Complete.**
charge or obligation.

Illustrated Catalogue Post Free or Call.

I.D.S. 4, Golden Sq. (Piccadilly Circus), W.1.
Telephone: Gerrard 2437.

Components, Etc., for Sale.—Contd.

BANKRUPT and Surplus Stock—All Marconiphone, moving coil speakers, all types, £3/3, list £6/6; D.C.B. amplifiers, £6/6, list £12/12; A.C.G.A. eliminator, with valve, £4/5, list £6/10; Ideal transformers, L.F., 6-1, 8-1, 12/6, list 25/-; power transformers, 100 or 200v., 18/6, list 37/6; all types, 100 volts, 12/6; receivers: model 23, £5, list £8/18/6; 23A, £6/10, list £11/15; 32A, pedestal, £15; 51 5-valve, £10/10, list £23/15; all with valves, as new; Ediswan smoothing unit, 30/-, list £4; Threesome kit sets, complete, 39/6; Telag 3-guinea pedestal speaker, 32/6; W.B. 39/6 speaker, 29/6; Triotron and 12in. chassis, 16/6; double cone chassis, 7/6, list 11/6; see advt. "W.W.", June 18; all guaranteed; stamp for my list of surplus goods.—Commercial Hill Crest, Horninglow, Burton-on-Trent. [9381]

EDISWAN 2v. Pentode, 12/6; Cossor H.F., 5/-; 2 P.M. 2S, 7/6 each; Dubilier R.C. unit, 4/-; Ormond 0.00035 all-metal S.L.F., 7/6; all practically unused.—27, Jersey Av., St. Annes, Bristol. [9878]

FOUR Haynes Griffen Super Het. Intermediate Transformers, 17/6; 5 Lewcos C.T. coils, 10/-; 8 Lisenin coils, 17/6; postage extra.—Watts 1, Elton Rd. (entrance Elmdale), Tyndall's Park, Bristol. [9876]

HAND Generator, 600 volts, £2/10; transmitting valves, filament volts 5.8, 5/-; guarantee and perfect; Marconiphone, on stand, never used, 12/6; Marconi Ideal choke, 10/-; Powquip transformer, 4/-; Brown's amplifier, 12/-; resistance unit, etc., etc., 4/-.—Turner, 13, Elgin Av., London, W.9. [9875]

BROWN'S 'Phones, Dimic and Irganic coils, valves, excellent condition; cheap.—143, Frimley Rd., Camberley. [9874]

EKCO IV 20 A.C. Eliminator, as new, £3 or offer; A.C. charger, 0-12 volts, 24-96, 30/-; Colvern Orgola coils, 12/- pair; Colvern dual range coil, 10/-; 66K unit, 12/6; P.M.12, 12/-; P.M.2D.X., 5/-; P.M.22, 12/-.—J. Rose, 10, Fairmile Av. Streatham, S.W.16. [9872]

GRASSMAN M.C. Speaker, 200v., D.C., 60/-; 2 Climax 300 m.a. chokes, 14-28 hy., 8/- each; R.I. automatic pick-up arm, 8/6; D.O.20 valve, 15/-.—Clark, 35, Higher Drive, Purley. [9870]

BAKER'S M.C. Speaker, 45/6; Marconi M.C. speaker, 35/6; both 6-volt; Blue Spot double line diaphragm, £1; 2 L.S.5As, 7/6 each; B.T.H. type universal gram. motor, 55/6; Palliard 3 record spring motor, 25/6; seen and heard.—Davison, 18, Cavendish Rd., New Malden. [9869]

SENIOR Mullard Orgola Parts Sold Separately; any article half list price; Varley push-pull transformers, input 12/-, output 11/-; L.F. choke, 10/-; Colvern coils, 21/-; filament transformer, for L.S.6As, in push-pull, 10/-; 2 H.F. chokes, 3/6 each; 2 Varley Antimobo units, 4/- each; 1 R.C. unit, Mullard, 7/6; 3 G.E.C. condensers, 0.0005, 8/- each; 3 T.B. valves, unboxed, 11/- each; 3 L.S.6As, 15/- each; H.T. eliminator, new, output 400 volts, 173 milliamps, £8.—Newth, 31, George St., Hanover Sq., London, W.1. [9890]

MISCELLANEOUS.

ALEXANDER BLACK,
THE Original Wireless Doctor, will call (London and Home Counties) and cure your set.

CONSULTATIONS by Appointment Without Obligation, sets installed, maintained, and brought up to date, gramophone pick-ups, eliminators, and Webson moving coil speakers demonstrated; purity reproduction specialists.

55 Ebury St., Victoria, S.W.1. Sloane 1655. [0277]

SCOTT SESSIONS and Co., Great Britain's Radio doctors, officially approved as wireless repairers by Radio Society of Great Britain and Wireless League; old sets of every type repaired, rebuilt, modernised; send set for immediate quotation.

SCOTT SESSIONS and Co.—New sets constructed with your or our components, guaranteed finest workmanship; we specialise in "The Wireless World" circuits; remember, we have satisfied customers throughout the British Isles and in three Continents; if you so desire, we will design and construct high grade apparatus to suit your especial circumstances for quality, range and selectivity.—Tel.: Tudor 5326. [0262] Muswell Hill, London, N.10.

ENGINEERS, novice or expert, £300, £400, £500 per year or more is within your grasp. In our handbook, Engineering Opportunities, Prof. A. M. Low explains where the good posts abound. This handbook has shown the way to better things to over 20,000 of your fellows. It contains details of A.M.I.Mech.E., A.M.I.E.E., A.M.I.C.E., A.M.I.A.E., A.M.I.Struct.E., Matric, C. & G., G.P.O., etc., exams., outlines home study courses in all branches of electrical, mechanical, motor and wireless engineering, and shows the unique advantages of our Appointments Department. Why stay in the Hammer and File Brigade? Send for our free handbook at once, stating branch, post or exam, which interests you.—British Institute of Engineering Technology, 87, Shakespeare House, 29-31, Oxford St., London, W.1. 9726



**"ECHOPHONE"
DOMESTIC & OFFICE
TELEPHONE**
Calling and Speaking both ways. The most economical and reliable private Telephone known.

So sensitive that conversation can be carried on in a whisper. The New "ECHOPHONE" eliminates the most unreliable part of all small telephones, i.e. the electric bell call. An entirely new call system is employed—discreet yet sufficiently loud to attract attention.

NO BREAKDOWNS owing to corroded electric bell or spring contacts are possible; such contacts are entirely avoided in the "ECHOPHONE." There are no delicate mechanical parts likely to get out of order. Each pair of Instruments is **GUARANTEED** for 2 YEARS.

PRICE, including 25 yards connecting wire,
Per Pair 28/6

Extra connecting wire 2d. per yard. Any small pocket battery will operate the "ECHOPHONE" for many weeks, or we can supply two Dry Cells lasting 18 months for 3/-.
CAN BE INSTALLED BY ANYONE IN LESS THAN 1 HOUR.

Delivery from stock, by return post.
FREDK. ADOLPH, Actual Maker, 'Phone: 27, Fitzroy Street, London, W.1. Museum 8329.



**THE
POWERFUL
PERFORMER!**

It reproduces gramophone records with surprising fidelity... far better than you would think possible! The volume can be regulated to suit the requirements of 5 to 500 people. It can be wired to provide music simultaneously in two or more rooms (or halls). All from the A.C. mains. Amplifier comprises switch, fuses and mains equipment. The whole unit (save valves) is enclosed in a case of steel. We shall be pleased to send you full particulars of the

**TRIX
POWER
AMPLIFIER**

Manufacturers:
ERIC J. LEVER (TRIX) LTD.,
8/9, Clerkenwell Green, London, E.C.1.
'Phone: Clerkenwell 3014/5.

Miscellaneous.—Contd.

EASY Payments.—We supply, by easy payments, components, accessories, and sets, any make; 10% down, balance spread over 11 months.—Send list of requirements to London Radio Supply Co., 11, Oat Lane, London, E.C.2. [0337]

COMFORTABLE Digs. for Wireless Students Study in London, good food; very moderate.—Moore, 41, Finborough Rd., South Kensington, London, S.W.10. Phone: Kensington 1427. [9857]

IDEAL Radio Service.—Have your set periodically examined and kept in first class condition; do away with unnecessary replacements. Sets inspected regularly; small charge.—Full particulars from F. A. Field, 111, Highbury Park, London, N.5. [9871]

E. C. WIRELESS, all mains specialists; conversions, repairs; special parts to individual requirements; 14 years' experience.—28, Premier Place, High St., Putney, S.W.15. [9882]

PATENT AGENTS.

PATENTS and Trade Marks, British and foreign.—Gee and Co. (H. T. P. Gee, Member R.S.G.B. and A.M.I.R.E.), 51-52, Chancery Lane, London, W.C.2. Phone: Holborn 1525. [0001]

REPAIRS.

SCOTT SESSIONS and Co., Great Britain's radio doctors; read advertisement under Miscellaneous column. [0263]

THE BARNES RADIO SERVICE.—Repairs, re-building, demonstrations, radio gramophones and scratch filters; reproduction specialists; any distance.—53, High St., Barnes, S.W.13. Prospect 5633. [9705]

GUARANTEED Repairs by Experts.—Loud-speakers, headphones, cone units, pick-ups, any type, re-wound, remagnetised, and adjusted post free 4/-; transformers, from 4/-.—Howell, 91, Morley Hill, Enfield, Middlesex. [9555]

WANTED.

ALL Types of Electrical and Wireless Apparatus Purchased for Cash; large quantities only.—T. W. Thompson and Co., 17, Strutton Ground, S.W.1. [0331]

WANTED, 200 volts H.T. accumulator, 5 ampere-hour, must be in good condition; also Burnpelt pick-up.—T. H. Bridgewater, 74, Egmont Rd., Sutton, Surrey. [9847]

PYE Plug in Coils, Nos. 34, 50, and 132; good condition essential.—Box 6541, c/o *The Wireless World*. [9829]

OLD Magnavox Horn M.C. Speaker; large exponential horn.—252, Berkhamsted Rd., Chesham. [9867]

EXCHANGE.

RADIO Part Exchange.—Particulars of the first and largest service in existence will be forwarded upon request to The Secretary, Appleby's, Chapel St., Marylebone, London. [0339]

EXCHANGE Camera, headphones, speaker; for new wet H.T., anything useful.—Race, Silsden, Keighley. [9879]

BUSINESSES & PROPERTY FOR SALE, TO BE LET, OR WANTED.

ACCUMULATOR Charging Station for Sale, East London district, modern; ill-health; all at, £250, or near offer; genuine opportunity for live man.—Apply, first instance, Charger, 130, Whitechapel Rd., E. [9856]

WIRELESS, gramophone and cycle business, North-west coast; good position and agencies; a real opportunity at £185, all in, stock worth more; frank details to principals.—Box 6594, c/o *The Wireless World*. [9840]

RADIO Business, well established, paying concern, living accommodation, low rent, genuine bargain, £850, including stock value £200, and other assets; situated south coast Devon.—Box 6614, c/o *The Wireless World*. [9861]

72 PAGE CATALOGUE

JULY ISSUE NOW READY.
Crammed with illustrations and details of all sorts of fascinating and useful gear, at very reasonable prices.

RADIO-ELECTRICAL-SCIENTIFIC INSTRUMENTS-MOTORS-GENERATORS

Just send a stamped envelope.
ELECTRADIX RADIOS,
218, Upper Thames Street, E.C.4
City 0191. Electradix, Cent, London.



The Finest High-grade Speaker in the World

PERFECT RECEPTION FOR MUSIC LOVERS

BAKER'S 'selhurst' RADIO

Offices: 89, Selhurst Rd., S. Norwood, S.E.25. Works: 42, Cherry Orchard Rd., Et.Croydon.

Super Power Moving Coil Speaker.

PAREX



BAKELITE DRUM DIALS and Escutcheons 5/6 per set. Cabinets, Coils, etc., for New Kilomag 4, Kit Set, etc.

"THE BAND PASS 4"
Set of 5 Screening Boxes, 25/-
Set of 10 Coils - - 55/-

E. PAROUSSI,
10, Featherstone Buildings, W.C.1.
Phone: Chancery 7010.

BOOKS on WIRELESS

Write for complete list to
LIFFE & SONS LTD.,
Dorset House, Tudor St., London, E.C.4.

SITUATIONS VACANT.

WIRELESS Operating; fees payable after appointment; amateur Morse classes.—Manager, Wireless School, 21, Manor Gardens, London, N.7. [9375]

FOUR Travellers Required by Leading Radio Manufacturers, 2 for Birmingham and Midlands area residing in that district, and 2 for London, Southern and Home Counties; must have experience of radio retail trade; salary and expenses.—Write age, experience, Box 6612, c/o *The Wireless World*. [9884]

WIRELESS Services.—The premier telegraph college in the British Isles (established 34 years) gives a sound training to all students, with assured positions on qualification; fees are not disguised under expensive board-residence scheme, but are payable by easy instalments, if desired.—Apply for Prospectus, Dept. "W.W.", The London Telegraph Training College, Ltd., Morse House, Earl's Court, S.W.5. [9877]

SITUATIONS WANTED.

SERVICE Engineer Requires Post with Manufacturers or Talkie Company, trained under leading electrical and gramophone companies, experienced modern mains receivers, radiograms, power amplifiers, sales experience.—Box 6604, c/o *The Wireless World*. [9858]

REQUIRED, position with wireless firm; good knowledge wireless telegraphy; excellent references.—Box 6557, c/o *The Wireless World*. [9830]

ADVERTISER (32), married, 15 years' experience marine radio work, 1927 P.M.G., A.M.I.R.E., desires post instructor wireless school, inspector or superintendent reputable wireless concern; salary £300.—Box 6606, c/o *The Wireless World*. [9860]

EXPERIENCED Wireless Traveller Seeks Improved Position, excellent connection London and Provinces, and own car.—Box 6611, c/o *The Wireless World*. [9883]

BOOKS, INSTRUCTION, ETC.

FREE: Inventor's Guide on Patents.—T. A. A., 253, (W), Gray's Inn Rd., London, W.C.1. [6373]

TELEVISION.—The complete authorised book on television (Baird Experimental) transmission and receiving is now ready; order "Television To-day and To-morrow" (Moseley and Barton Chapple), 7/6 net.—Pitman's, Parker St., Kingsway, W.C.2. [9309]

STEP by Step Wireless.—A complete course of instruction for wireless engineers; send 1/- for first 4 weeks.—Clifford Pressland, A.M.I.E.E., Hampton-on-Thames. [0195]

SPECIFIED for the

"BAND PASS FOUR"

Polar "Universal" 0005 - - 7/6.

WINGROVE & ROGERS Ltd.
188-9, Strand, London, W.C.2.



POLAR

The AMATEUR PHOTOGRAPHER & CINEMATOGRAPHER

The Journal for Everybody with a Camera

EVERY WEDNESDAY 3d. W.W.37

INDEX TO ADVERTISEMENTS.

	PAGE		PAGE		PAGE
Abbey Radio	11	Garnett, Whiteley & Co., Ltd.	9	Paroussi, E.	12
Adolph, Fredk.	8	General Electric Co., Ltd.		Partridge & Mee, Ltd.	6
Appleby, E. Hetherington	12	Healyard, P. C., & Co.	Cover i & page 1	Parsens Manf. Co., Ltd.	10
Baker's "Selhurst" Radio	8	Holzman, L.	Cover i	Perrin, Ltd.	7
Belling & Lee, Ltd.	11	Hughes, F. A. & Co., Ltd.	Cover i	Philips Lamps, Ltd.	3
Burne-Jones & Co., Ltd. (Magnum)	2	I.D.S., Ltd.	11	Player's	6
Celestion, Ltd.	Cover i	Imperial Airways, Ltd.	2	Potter, H. B., & Co., Ltd.	2
Cole, E. K., Ltd.	10	Jackson Bros.	10	Regent Radio Supply Co.	10
Darwins, Ltd.	11	Jolly, P. W.	11	Rich & Bundy, Ltd.	8
Day, Will, Ltd.	5	Lever, Eric J. (Trix), Ltd.	11	Rigby & Woolfenden	10
Eastick, J. J., & Sons	12	London Electric Wire Co., & Smiths, Ltd.	Cover ii	Sherwood, A. M. E.	10
Edison Swan Electric Co., Ltd.	10	Marconiphone Co., Ltd.	4	Thomas, Bertram	10
Electradix Radios	10	McMichael, I., Ltd.	Cover ii	Transformer Repair Co.	10
Ever Ready Co. (G.B.), Ltd.	8	M-L Magneto Synd., Ltd.	Cover i	Varley (Oliver Pell Control, Ltd.)	
Exact Manf. Co.	8	Mullard Wireless Service Co., Ltd.	Cover i	Westinghouse Brake & Saxby Signal Co., Ltd.	Cover iii
Exide Batteries	8	Parker, W. H.	10	Wingrove & Rogers, Ltd.	12
Fonteyn & Co., Ltd.	7			Wright & Weaire, Ltd.	Cover iii
Forno Co.					

Mention of "The Wireless World," when writing to advertisers, will ensure prompt attention.

Reliability is essential

This illustration shows a



METAL RECTIFIER

of six kilowatts output, mounted on top of a switchboard and transformer cubicle. Two of these sets are installed in sub-stations operating a large railway power signalling installation. The D.C. outputs are used for the operation of electric point machines, and these rectifiers have been delivering the necessary heavy output efficiently for nearly eighteen months.

The same degree of reliability and efficiency is obtainable from the smaller rectifiers for radio mains equipment.

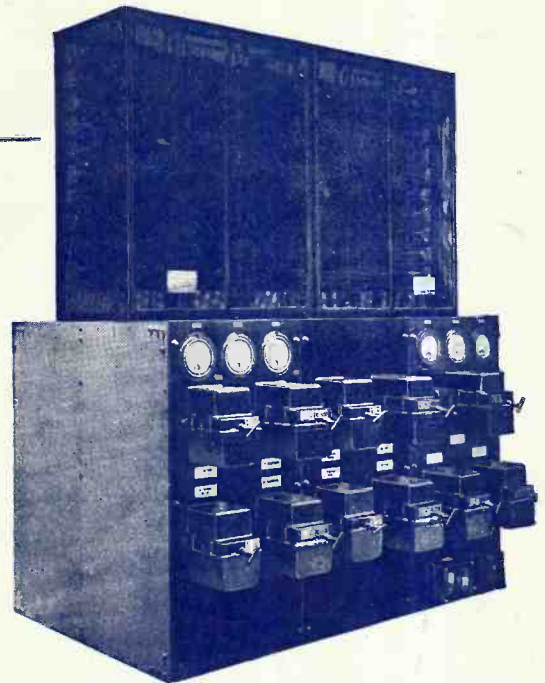

Full details and circuits for all units for radio mains equipment are given in our 32-page booklet, "The AM Metal Way—1930." Send 2d. stamp for a copy to

The Westinghouse Brake & Saxby Signal Co., Ltd.
82, York Road, King's Cross, London, N.1.

The Yachting World and Motor Boating Journal

Covers Every Aspect
of Yachting and Motor Boating
FOUNDED 1894

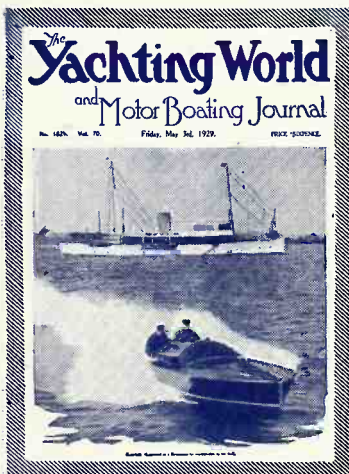

All who are interested in power-craft, whether cruisers, speed-boats or outboards, will enjoy reading "THE YACHTING WORLD and MOTOR BOATING JOURNAL."

It is a well-produced and attractive paper dealing with yachts and boats of all types and tonnages on sea and inland waters.

Racing, cruising, deep-sea sailing, practical seamanship and the construction of small craft are among the chief subjects of interest.

SUBSCRIPTIONS: Home and Canada, £1. 10. 4, other countries abroad £1. 12. 6, per annum, post free

Every Friday 6^d.

ILIFFE & SONS LTD., Dorset House, Tudor Street, London, E.C.4.

W.W.81

GUARANTEED

WEARITE

COMPONENTS

MAINS TRANSFORMERS AND L.F. CHOKES

Type	Output	Use	Price.
T.1	4 v 5 a	For Heaters of A.C. Valves	25/-
T.2	4 v 5 a 5.5 v 2 a 250 v 80 m/a	For H.T. & L.T. For A.C. Valves Also U.5 Type Rectifier	
T.3	135 v 0 m/a	For Westinghouse Rectifiers Styles H.T.3 & H.T.4	37/6
T.4	135 v 50 m/a 4 v 5 a	As T.3 with addition of windings for A.C. Valve Heater	27/6
T.5	230 v 50 m/a 4 v 5 a	For Westinghouse Rectifier Style H.T.1, also A.C. Valve Heater Winding	32/6

Type	CONSTANT INDUCTANCE		L.F. CHOKES.	Price.
	Inductance (Henries)	Resistance (Ohms)	Current-carrying capacity	
L.T. 1	0.1	0.5	1.5 amps	18/6
L.T. 2	0.25	1.5	1.0 "	18/6
H.T. 1	10	190	120 m/a	21/-
H.T. 2	20	350	75 "	21/-
H.T. 3	40	850	50 "	21/-
H.T. 4	100	1850	25 "	21/-
H.T. 5	20	400	30 "	12/6
H.T. 6	60	2500	15 "	15/-

Special Transformer for "Orgola" High Power H.T. Supply Unit 30/-
H.F. By-Pass Unit 4/6

Write for free illustrated lists

WRIGHT & WEARE LTD.,
740, HIGH ROAD, TOTTENHAM, N.17. Phone: Tottenham 3847/8.



The family favourite

THE fall in the value of metals and raw materials, and increased production, enables us to reduce prices.



ARE DOWN IN PRICE

WINNER SERIES

60 VOLTS ~~7/~~ 6/6

66 VOLTS ~~7/6~~ 7/

99 VOLTS ~~11/6~~ 10/9

120 VOLTS ~~14/~~ 13/

Obtainable Everywhere

These reductions give value second to none, for two-valve sets requiring 6 m.a. emission. Ask for an EVER READY next time if you require 100% service at minimum cost.

The Ever Ready Co. (G.B.) Ltd.,
Hercules Place, Holloway, London, N.7.

Printed for the Publishers, ILLIFFE & SONS LTD., Dorset House, Tudor Street, London, E.C.4, by The Cornwall Press Ltd., Paris Garden, Stamford Street, London, S.E.1.

Colonial and Foreign Agents:
 UNITED STATES—The International News Co., 131, Varick Street, New York. FRANCE—W. H. Smith & Son, 248, Rue Rivoli, Paris; Hachette et Cie, Rue Réaumur, Paris.
 BELGIUM—W. H. Smith & Son, 78, Marche aux Herbes, Brussels. INDIA—A. H. Wheeler & Co., Bombay, Allahabad and Calcutta. SOUTH AFRICA—Central News Agency, Ltd.
 AUSTRALIA—Gordon & Gotch, Ltd., Melbourne (Victoria), Sydney (N.S.W.), Brisbane (Queensland), Adelaide (S.A.), Perth (W.A.), and Launceston (Tasmania).
 CANADA—The American News Co., Ltd., Toronto, Winnipeg, Vancouver, Montreal, Ottawa, St. John, Halifax, Hamilton; Gordon & Gotch, Ltd., Toronto; Imperial News Co., Toronto, Montreal, Winnipeg, Vancouver, Victoria. NEW ZEALAND—Gordon & Gotch, Ltd., Wellington, Auckland, Christchurch and Dunedin.

BATTERY AND D.C. FOREIGN LISTENER'S FOUR

The Wireless World

AND RADIO REVIEW

The Paper for Every Wireless Amateur

Wednesday, July 9th, 1930.

4^D

BurTON VALVE HOLDER



MANUFACTURED BY C. F. & H. BurTON

PROGRESS WORKS WALSALL, ENG.

Pentode - Valve - Holders 1/6 each

Patent No. 316708



TELSEN L.F. TRANSFORMERS

Radio's Choice

Have acquired a world-wide reputation for Quality and Value. Built by Specialists in Transformer construction they have set a Quality of Performance above reproach. Your Set will work better with a Telsen Transformer - - - Fit one now!

Radio grand 12/6
Ratios 3-1 & 5-1
Radiogram 7-1
Ratio Price 17/6.

TELSEN ELECTRIC CO. LTD., Miller St., Birmingham.

VIVIDLY NATURAL RADIO WITH THIS SUPREME SPEAKER



If your set is old or new, large or small, the Ultra Air Chrome Speaker will give you radio with a atmosphere, character, temperament and vitality. Vividly natural, playing, singing or talking, with perfect acoustic balance over the full compass of orchestra and voice. From all dealers

50%

ULTRA AIR CHROME SPEAKER

WITH THE DOUBLE LINEN DIAPHRAGM

ULTRA ELECTRIC LIMITED, 661, HARROW ROAD, LONDON, N.W.1

McMICHAEL PORTABLE RECEIVER 22 GNS.

Point No. 1.

SELECTIVITY.

At the gates of Brookmans Park (both wavelengths being radiated) both programmes and Continental stations were received with complete separation.

Hear it at any high-class radio store or our London showrooms.

L. McMICHAEL LTD., Wexham Road, Slough, Bucks, 179, Strand, London, W.C.2.



THE FACTOR OF SAFETY!

"Why pay 3/- for a 2 Mfd. condenser tested at 500 v. when I can buy one of this capacity tested at 1,500 v. for the same money?" This question was put to us by a manufacturer only a few days ago, and as the point must interest many other manufacturers, we will repeat the answer we gave.

A high test voltage can very easily be given by lowering the ratio between test and breakdown until the figure for the test voltage is only just under that of the breakdown. The condenser which breaks down at, say, 1,700 or 1,800 volts having been offered as being tested at 1,500 v.

But a first-class condenser should have a high safety factor between the test voltage and the breakdown voltage. For instance, a Hydra condenser sold

under, say, a test figure of 500 v. D.C. would not break down under 1,700 v. average, which, therefore, gives a safety factor of over three times the test voltage.

As an instance of the Hydra safety ratio, the Hydro Electric Commission of Canada took six Hydra units, tested at 1,000 v. D.C., from stock, and found that the average breakdown voltage was 3,800 v., and some of the units stood up until 4,700 v. were applied.

It pays to find out the ratio of test voltage to breakdown.

Hydra condensers are the first paper di-electric condensers to receive the approval of the Canadian Hydro Electric Commission as *safe* condensers for use across motors to suppress radio interference, and between mains and set.

**LOUIS
HOLZMAN LTD.
37, Newman Street
W.1.**

'Phone: Museum 2641.

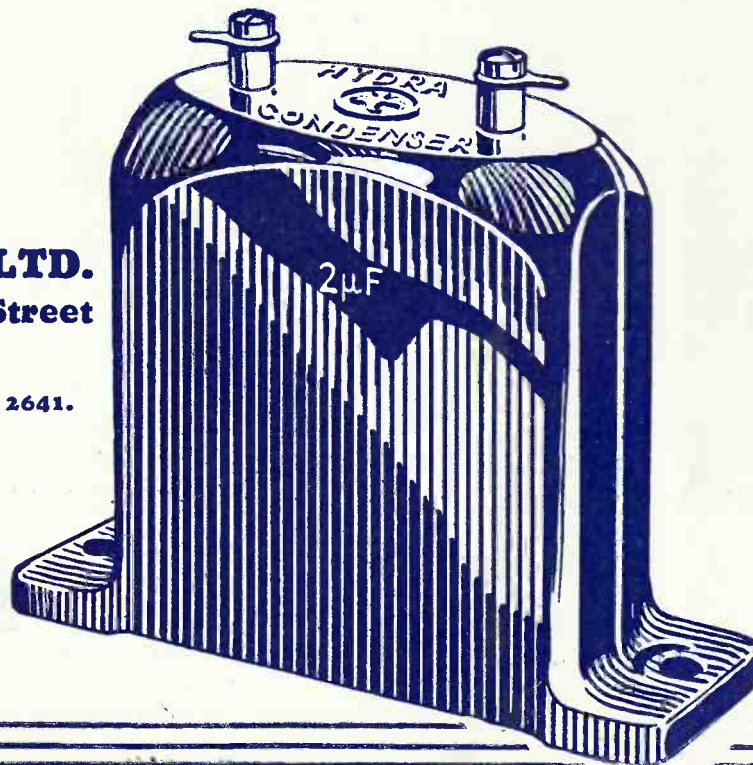

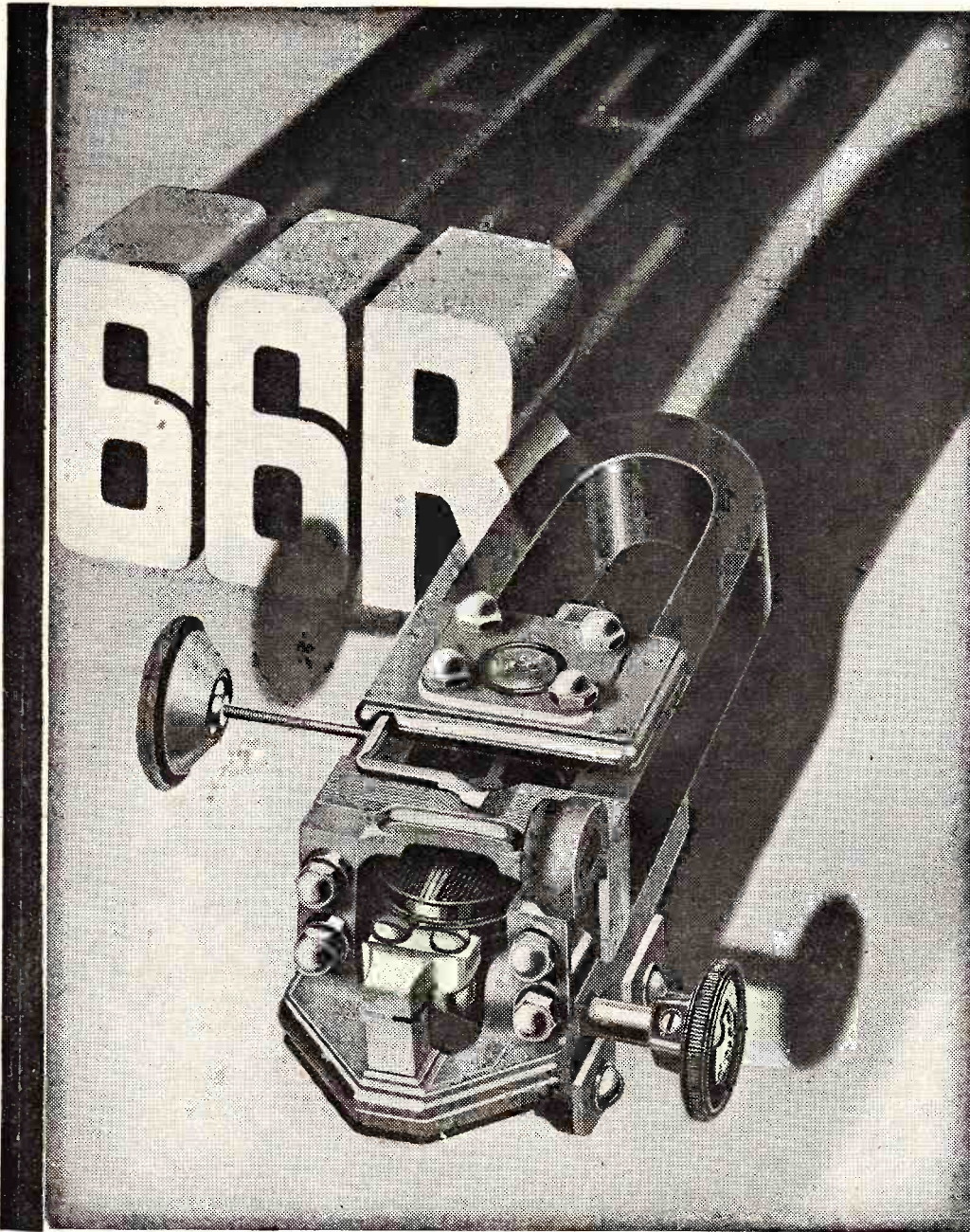

BLUE SPOT'S MASTERPIECE 35/-

F. A. HUGHES & CO., LIMITED, 204-6 GREAT PORTLAND ST., LONDON, W.1

*Distributors for Northern England, Scotland and North Wales: H. C. RAWSON (Sheffield and London), LTD.,
100 London Road, Sheffield. 22 St. Mary's Parsonage, Manchester.*

TESTS OF TIME

Built by ..

... Sir Christopher Wren in 1671—259 years ago, the Monument certainly has stood the test of time. T.C.C. "the condenser in the green case," too, has stood the test of time—and come through with flying colours.

The Telegraph Condenser Co. have been making condensers for a quarter of a century—so, remember, run no risks when choosing the condensers for your Set, follow the experts' lead: choose T.C.C. the guaranteed condenser and know that you are getting dependability.

Every good Wireless Dealer sells them!

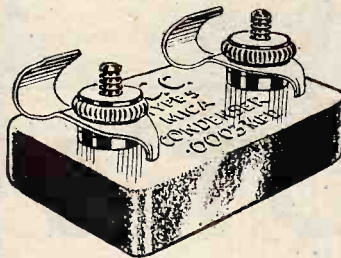

The condenser illustrated is the .0003 mfd. T.C.C. flat mica type 1/3d.

THE MONUMENT

ADVERT. OF THE TELEGRAPH CONDENSER CO. LTD., BENTON, W.3.

Utility

IMPROVED PATTERN ANTI-CAPACITY SWITCH

Write for Illustrated List POST FREE.

Absolutely the latest Switch for portables—small size, compact, and with several unique constructional features that will appeal to you. Fully Guaranteed by the makers and stocked by all high-class Wireless Dealers. Write for List of Dials, Condensers, etc.

WILKINS & WRIGHT LTD
HOLYHEAD? *Utility* BIRMINGHAM

SWITCH W.190

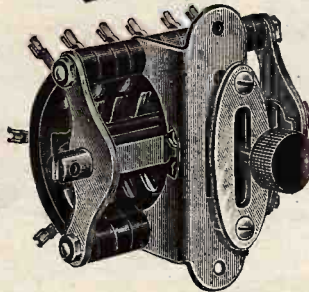

PRICES

W.190/1	1-pole change over	4/3
W.190/2	2-pole	5/-
W.190/3	3-pole	6/-
W.190/4	4-pole	7/6
W.190/5	5-pole	9/6
W.190/6	6-pole	9/6

RADIO DATA CHARTS

A SERIES OF ABACS

providing most of the essential Data required in Receiver Design

By R. T. BEATTY, M.A., B.E., D.Sc.

"Radio Data Charts" provide designers of wireless apparatus with a ready and convenient means of solving problems without having recourse to complicated formulæ and mathematics.

By the use of the charts it is possible to tackle all the more familiar problems in radio receiver design; including, for example, finding the relationship between inductance capacity and frequency, and working out the design of high frequency transformers. All keen amateurs will appreciate this helpful book.

Price 4/6 net. By post 4/10.

From all leading booksellers or direct from the publishers.

Published from the Offices of "THE WIRELESS WORLD,"

Dorset House, Tudor Street, London, E.C.4. W.W.93

ALL MAINS RADIO AT



ITS BEST!

PRICE:
A.C. or D.C.
£25

Generous Hire Purchase terms can be arranged.

Dubilier all mains sets are the result of the specialised knowledge of Dubilier engineers combined with modern manufacturing methods to produce real instruments—not an assembly of odd components. All the latest practices have been incorporated in the design of Dubilier sets and they are unequalled by any other 3-valve set for quality, range and volume.

DUBILIER CONDENSER CO. (1925) Ltd.,
Ducon Works, Victoria Road, North Acton,
London, W.3.

DUBILIER

ALL ELECTRIC RADIO

PLUG SIX-SIXTY VALVE ADAPTORS INTO EXISTING SOCKETS—

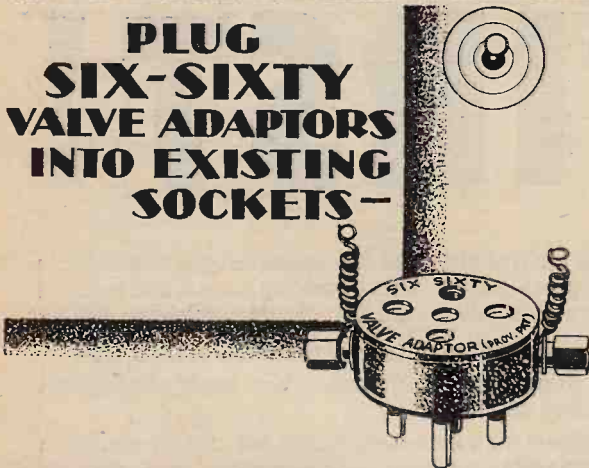

YOUR SET CONVERTED FOR A.C. VALVES

You can convert an A.C. set for D.C. Valves or a D.C. set for A.C. Valves with the **SIX-SIXTY VALVE ADAPTORS**. All you have to do is to plug in **SIX-SIXTY VALVE ADAPTORS** into existing sockets—if you are converting your set to A.C. Valves you connect up the wires attached to the Mains drive—and your set is ready. **SIX-SIXTY VALVE ADAPTORS** will modernise your set. Price 2/- each for A.C. Adaptors, 1/6 each for D.C. Adaptors.

SIX-SIXTY VALVE ADAPTORS

Made by the makers of the famous Six-Sixty Valves.

Six-Sixty Radio Co. Ltd., Six-Sixty House, 17/18, Rathbone Place, Oxford St., W.1.
Telephone: Museum 6116/7.

Weston sets the world's standard



Model 506, Pin Jack Voltmeter complete with high range standard testing cables.

Price £2. 10. 0

To obtain the very best results from your receiver, you must be quite sure that the High Tension, Low Tension and Grid Bias Voltages are regulated correctly.

For exact measurements of these variable voltages be sure you use a Weston Pin Jack Voltmeter.

It is sold by all Radio Dealers as the finest instrument for accuracy and reliability.

WESTON

ELECTRICAL INSTRUMENT CO., LTD.,

15, Great Saffron Hill, London, E.C.1

A.2



**Comparison
has placed it**

FIRST!

PRICE £3.3.0

INCLUDING TEMPLATE FOR FIXING

**Ask your Dealer
for a Demonstration.**

The common faults of almost all Pick-ups have been eliminated in the Marconiphone design. Tests by leading musical and technical experts have definitely proved that the Marconiphone Pick-up

- 1 has an ideal response curve over the whole musical scale
- 2 gives a rising bass characteristic which amply compensates for recording deficiencies
- 3 yields brilliant high note reproduction but cuts off sharply to eliminate needle scratch
- 4 has a properly designed carrier arm which ensures correct tracking
- 5 imposes less wear on records than any other Pick-up
- 6 will follow the record grooves perfectly down to 25 cycles
- 7 is the most convenient for ease of operation owing to its cleverly designed swivelling head
- 8 gives the highest output of any Pick-up on the market ensuring full volume with only two amplifying valves.

Marconiphone Pick-up

Mention of "The Wireless World," when writing to advertisers, will ensure prompt attention.

The Wireless World

AND
RADIO REVIEW
(18th Year of Publication)

No. 567.

WEDNESDAY, JULY 9TH, 1930.

VOL. XXVII. No.2.

Editor: HUGH S. POCOCK.

Assistant Editor: F. H. HAYNES.

Editorial Offices: 116-117, FLEET STREET, LONDON, E.C.4

Editorial Telephone: City 9472 (5 lines).

Advertising and Publishing Offices:

DORSET HOUSE, TUDOR STREET, LONDON, E.C.4.
Telephone: City 2847 (13 lines). Telegrams: "Ethaworld, Fleet, London."

COVENTRY: Hertford Street.

Telegrams: "Cyclist, Coventry." Telephone: 5210 Coventry.

BIRMINGHAM: Guildhall Buildings, Navigation Street.

Telegrams: "Autopress, Birmingham." Telephone: 2970 and 2971 Midland.

MANCHESTER: 260, Deansgate.

Telegrams: "Hiffe, Manchester." Telephone: 8970 City (4 lines).

GLASGOW: 101, St. Vincent Street, C.2.

Telegrams: "Hife, Glasgow." Telephone: Central 4857.

PUBLISHED WEEKLY.

Subscription Rates: Home, £1 1s. 8d.; Canada, £1 1s. 8d.;
other countries abroad, £1 3s. 10d. per annum.

Entered as Second Class Matter at New York, N.Y.

As many of the circuits and apparatus described in these pages are covered by patents, readers are advised, before making use of them, to satisfy themselves that they would not be infringing patents.

greater than the difficulty of deciding how the cost of the service was to be defrayed. The B.B.C. now emphasises the potential value of the service to the Empire, and undertakes to organise and conduct the service provided that some other authority is prepared to meet the out-of-pocket expenses incurred.

In the discussion on Empire Broadcasting which followed Sir John Reith's evidence before the Conference, it is understood that the project met with unanimous support, so that one is inclined to adopt a distinctly optimistic view of the possibility of the necessary funds becoming available to enable Empire Broadcasting to go forward on a proper basis.

It is, perhaps, difficult at this stage to visualise the potentialities of the establishment of a service which will reach all parts of the Empire, but we believe that in years to come Empire Broadcasting will have proved to be one of the strongest links in maintaining the unity of the British Empire.

o o o o

THE B.B.C. REPORT.

THE third annual report of the B.B.C. to His Majesty's Postmaster-General has now been published, and constitutes a record of the progress and activities of the Corporation during the year 1929.

Reading the report one cannot help being struck with the number of tasks which the organisation undertakes, though many of these tasks, we must add, appear to be self-imposed, and not necessarily essential to the conduct of a broadcasting service. To have built up so strong and efficient an organisation in a comparatively short space of time is undoubtedly an achievement of which those responsible are entitled to be proud. It is, however, a pity that an attitude of self-satisfaction and complacency should find expression so freely in a purely official report. There have been, and there still exist, a number of instances where B.B.C. policy has by no means met with unanimous approval from the public. As an instance, we find on the first page of the report that the Corporation relies upon statistics to justify an educational bias. Statistics are notoriously misleading when employed with the object of arriving at conclusions on public opinion. We do not doubt but that the B.B.C. has had an enormous response from appreciative listeners in respect of their educational activities, but one should not therefore jump to any conclusions as to the prevailing tastes of that much larger proportion of listeners who have failed to express themselves either for or against the B.B.C.'s educational policy.

CONTENTS OF THIS ISSUE.

	PAGE
EDITORIAL VIEWS	29
D.C. FOREIGN LISTENER'S FOUR. BY F. H. HAYNES	30
APERIODIC H.F. AMPLIFICATION (CONCLUDED). BY A. L. M. SOWERBY	35
TELEVISION ON THE SCREEN	39
CURRENT TOPICS	40
LABORATORY TESTS ON NEW APPARATUS	41
PRACTICAL HINTS AND TIPS	42
WIRELESS THEORY SIMPLIFIED. PART XXXVI. BY S. O. PEARSON	44
CORRESPONDENCE	47
BROADCAST BREVITIES	49
READERS' PROBLEMS	50

EMPIRE BROADCASTING.

Signs of Real Progress at Last.

THE subject of Empire Broadcasting was one of the matters due for discussion at the Colonial Conference now sitting, but it had not been disclosed in what way the subject would be introduced. We now learn that Sir John Reith, representing the B.B.C., was called upon to give evidence and express an opinion in regard to future development.

We are glad to see that there has apparently been a complete change of attitude on the part of the B.B.C. towards the project, for in his evidence Sir John Reith is reported to have said that the present experimental station should not be regarded as all that could be done by a regular organised service, and he believed that if a high-power short-wave station were erected an efficient broadcast service to the Colonies would be possible. This is a very different view from that adopted until recently by the B.B.C., for our recollection is that the technical difficulties were considered to be even

D.C. FOREIGN LISTENER'S FOUR

BATTERY AND MAINS OPERATED MODELS



An Easily Constructed Long-range Receiver for Use with Limited H.T. Potential.

By F. H. HAYNES.

CONSTRUCTION that consists exclusively of the assembly of components has been rigorously respected in putting forward the present design. There should be no uncertainty, therefore, that the work of the constructor will not result in the performance claimed, nor will he regret the expenditure on the various components. Of the three designs given these observations apply particularly to the battery and D.C. high-tension eliminator models, which are capable of giving loud speaker reception of no fewer than twenty stations when connected to quite a small aerial. Careful switch-over tests between the battery set and a modern receiver of generous design chosen by experience as possessing the best distant station - getting properties have been made, using a loft aerial. With the one set as a standard of comparison no instance occurred of a station being tuned in where the programme could not equally well be followed from the battery-operated set.

Nearly a year has passed since the inclusion of a description of the Foreign Listener's Four, and in putting forward yet another design precisely the same circuit principle has been retained. Sufficient time has elapsed to confirm the performance of the receiver as an all-round set for long-range reception, and representing a combination of four valves most suited to average requirements.

The layout has, however, been rendered more compact, giving an easier and somewhat cheaper construction, while a well-finished appearance has been obtained as compared with the previous experimental assemblies. This time the circuit has been adapted for battery and D.C. mains working, although this modified form of assembly has been applied in the course of testing the set to A.C. mains by the use of a deeper

base-box that will house the A.C. rectifying equipment specified.¹

Details of the circuit principles having been previously discussed, a few general details only are given. By the use of two H.F. stages, long-range reception results not only by virtue of high overall magnification but by good selectivity, which this arrangement can provide. Detection by leaky grid also ensures long-range reception, while the non-linear sensitivity of this detector happily corrects for fading. The single output stage is adequately loaded by the detector, so that ample power output

results from the use of a modern output valve or pentode. Among the modifications now introduced is the inclusion of a volume control acting by regulation of screen voltage as an alternative to an adjustment of grid bias. While this is occasioned by the adaption of the receiver for battery working, it permits the H.F. stages to be operated right up to the point where amplification is limited by regeneration and brings about the desirable condition where range of reception is enor-

mously increased by the effects of reaction. This control of screen voltage is a desirable feature of receivers of this class, for as the tuning changes the ratio of inductance to capacity, and therefore considerably modifies both the amplification and the tendency to oscillate, this additional control maintains the circuits in a condition of maximum amplification, introduces reaction, and avoids uncontrollable self-oscillation. In operation, this control, which consists of a potentiometer, is particularly smooth in its action, is not critical in its setting for threshold regeneration, while, unlike the more usual

SPECIFICATION.

Two H.F. Stages with tuned grid couplings.
Totally Screened Tuning Coils incorporating wave-change switching and feed condensers.
Leaky Grid Detection.
Small Power Valve or pentode output.
Single-dial Tuning with aerial circuit trimmer.
Sensitivity Control regulating both volume and regeneration and having no effect on the critical ganged tuning.
Parallel-fed L.F. Amplifier.
Complete Screening and decoupling.
Sub-base Eliminator with metal earthing screen.
Circuits for (1) all-battery working, (2) H.T. from D.C. mains, (3) all D.C. mains working
All Wiring Easily Accessible.
Designed for Easy Construction and with a due regard to cost.

¹ Foreign Listener's Four, July 31st and August 7th, 1929. New Foreign Listener's Four, 12th and 26th February, 1930. Notes on the New Foreign Listener's Four, May 28th, 1930.

D.C. Foreign Listener's Four.—

methods of reaction control associated only with a positively biased detector, it suffers neither from "overlap" nor causes the circuit to suddenly drop into oscillation. It is, moreover, a control of selectivity, and, as the signal is weakened so as to avoid overloading, the number of degrees occupied by a station on the tuning dial narrows up rapidly. A broadening of the threshold setting of the regeneration control for maximum stable amplification results from the use of a potentiometer of so high a resistance value that the voltage drop produced by the screen current tends to off-set an increase in screen potential, while the current consumed is less than 3 mA. Little skill is required, therefore, to operate the set to its best advantage, the controls merely consisting of one-dial tuning and trimmer, a wave-change key, and a volume control which at the maximum end of its scale becomes an adjustment of reaction.

forms a complete barrier between the eliminator, or voltage regulator apparatus, and the signal carrying circuits, while providing a common point of earthing so that stray back couplings are avoided such as would occur by the picking up of earth connections at various points along a single lead. Secondly, the difficulties of wiring within screening compartments have been removed together with the mechanical difficulties of setting up and aligning the ganged wave-change switches. Screening containers have been produced to accommodate the coils so that the danger of inadequate bonding of corners and the stray couplings which may possibly result have been removed.

S.G. Stages Not Impaired by Coil Screening.

Amplification tests have been made to determine the effect of the screens on the coils and the minimum safe distance which should be allowed between them, like-

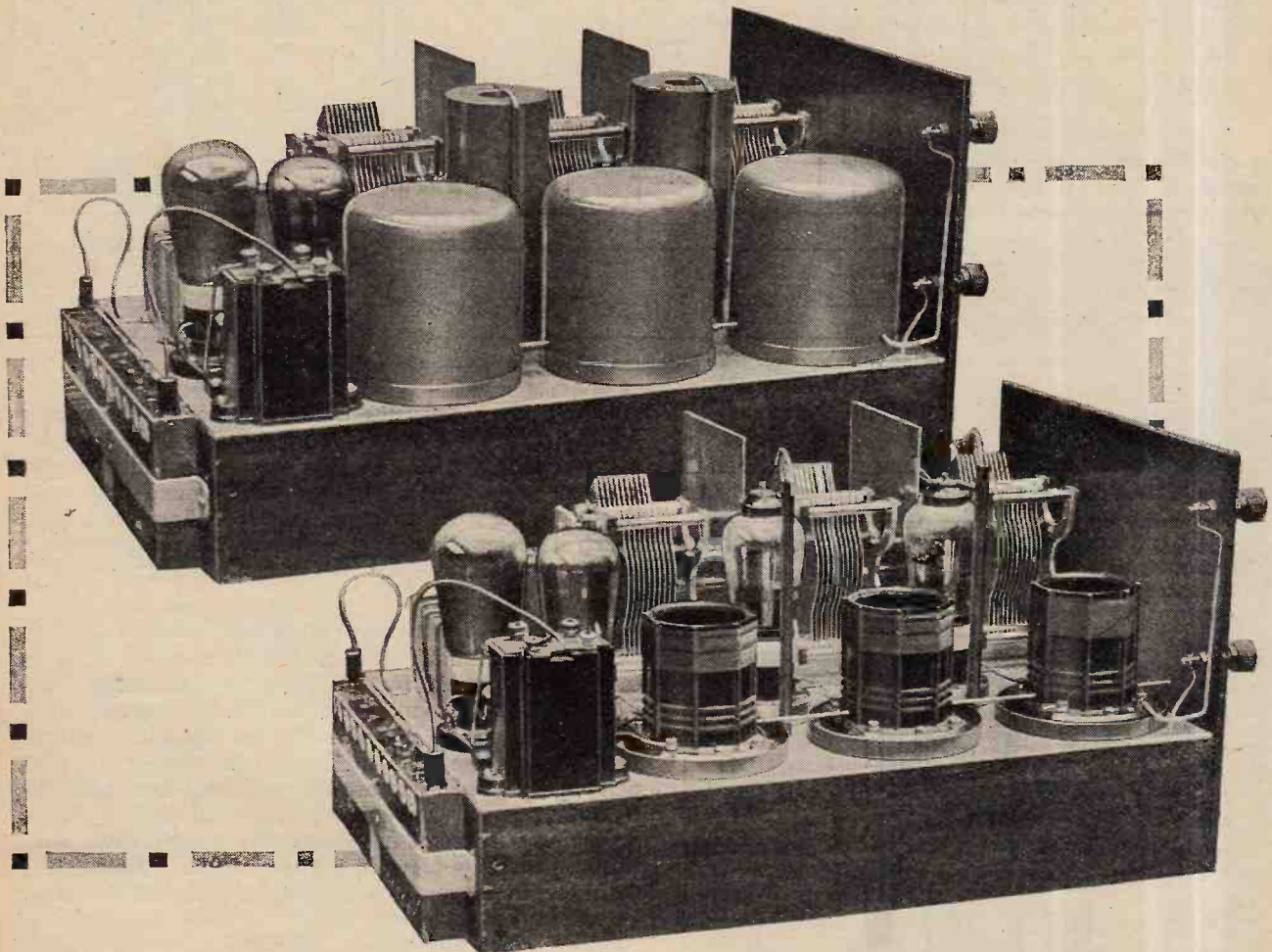

The layout of the components gives compactness with easy access for wiring. Very little of the wiring is exposed. The aerial trimming condenser, while in this case assembled on the base, is best fitted in the centre of the panel immediately over the volume control. When used with an aerial more than 20 feet in length an additional fixed-capacity condenser is inserted in the lead between the coil and the aerial terminal.

Constructional modifications on the previous designs include three features. The first, a hollow base which with an aluminium plate on its top side (or a piece of tin plate on the top or under side)

wise the influence of the long-wave section when tuning to the broadcast band. Safe working distances at which the selectivity and amplification given by the tuned circuit remain practically equal to those of the open coil

D.C. Foreign Listener's Four.—

were found by trial. It is curious to note that allowing for a small increase in the turns of the screen-enclosed coil that the efficiency of the tuned circuit as an inter-valve coupling following an S.G. valve with screened

ends of the coil and around it in the same way that the short-circuited long-wave section must not approach too closely to the broadcast band winding, though as soon as a certain distance is exceeded the effect is unobservable from a reception standpoint. In wave

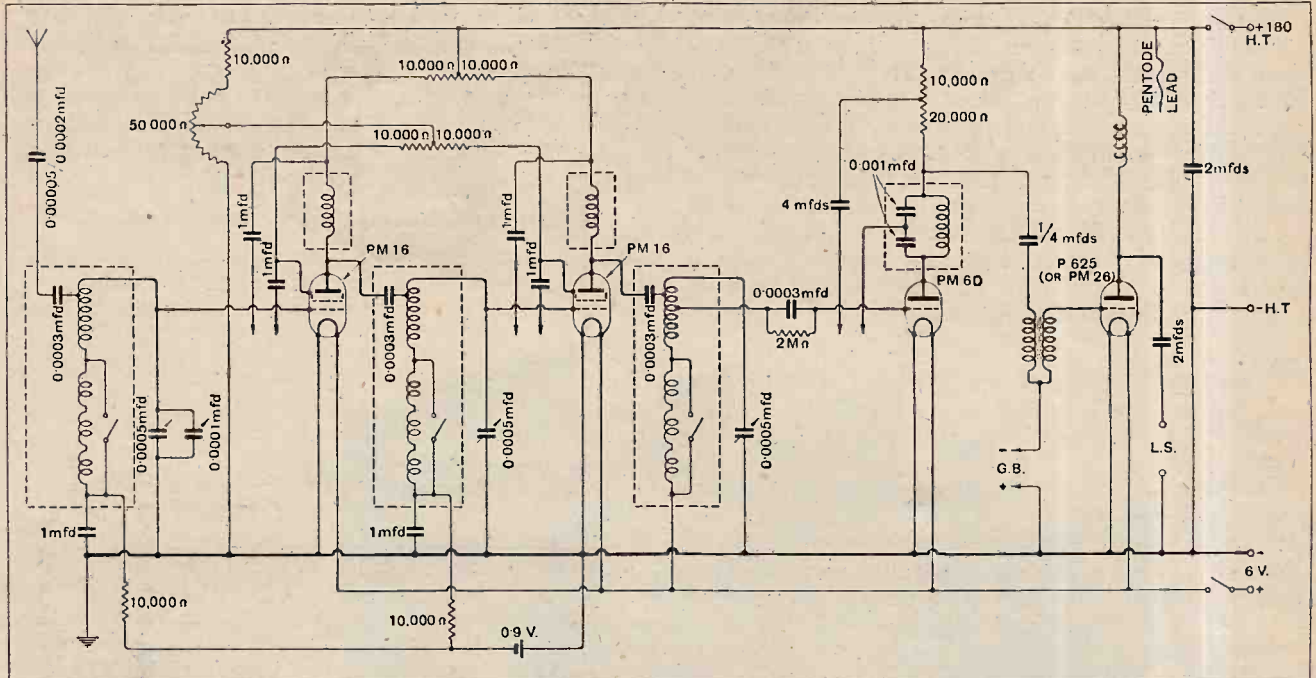

Circuit for battery-operated receiver with resistance values suitable for 180-volt H.T. supply.

or unscreened coil, proved to be the same at 400 metres, assuming the use of equal values of tuning capacity. There is, however, a certain critical distance which must be allowed at both the

changing the constructor is not involved in the setting up of switches, as simple spring contacts have been incorporated in the coils so that they are wired in circuit with the same ease as if they were wound only to a single range. In addition, the coupling condenser, which it is important to screen from the components of other stages, forms part of the complete screened coil unit.

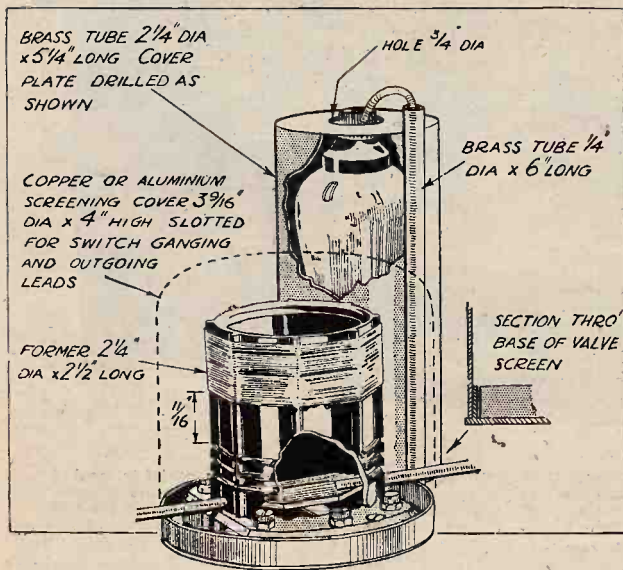

Coil and valve screens showing the leading dimensions. A rectangular piece of bakelite held in by a grub screw is rotated on an $\frac{1}{16}$ in. brass rod and actuates the wave-change switch in the base of the coil. The removal of the top terminal of the S.G. valve is facilitated by a saw-cut in the bakelite.

Capacity Shields for Valves and Condensers.

Lastly, the tuning condensers have been set up so as to be unobstructed by the customary screening compartments, and mounted and driven very simply by a direct drive on the end of a common spindle. Spacing bars such as are used in the construction of the condensers are used to secure the units together, holes already existing in convenient positions in the end plates. Screening barriers of flat metal effectively prevent electrostatic coupling between the sets of fixed plates. It is desirable, moreover, to completely cover in the two H.F. valves under screening tubes, as the stray capacity coupling which they present one to the other is considerable. Likewise, the anode lead is run through a tube down to the H.F. feed chokes. This latter requirement would be obviated were the grid connection taken from the top of the valve instead of the plate, and connected directly to the tuned circuit, as was the practice in certain early types of S.G. valves.

Three circuit arrangements are shown for building receivers for all-battery working, accumulator L.T. with

LIST OF PARTS.
BATTERY AND MAINS H.T. MODEL.

- 3 Variable condensers, square law, 0.0005 mfd. (Cylton A.5).
- 6 Spacing bars for ganging and end bracket.
- 1 Silver steel spindle, 13 x 1/4 in.
- 1 Potentiometer, 50,000 ohms (Colvern).
- 1 L.F. transformer, 4:1 (R. I. Hypermu).
- 1 Fixed condenser, 0.0003 mfd. with clips (Dubilier No. 620).
- 7 Fixed condensers, 1 mfd. 1,500 volt D.C. test.
- 5 Fixed condensers, 4 mfd. 1,500 volt D.C. test.
- 1 Fixed condenser, 2 mfd. 1,500 volt D.C. test (2 when pick-up is fitted).
- 1 Fixed condenser, 0.0001 mfd. (Polymet F.C. 1101).
- 1 Grid leak, 2 megohms (Loewe).
- 2 Resistances, 10,000 ohms (Loewe). (3 when pick-up is fitted).
- 2 Grid leak holders (Bulgin Porcelain).
- 4 Valve holders (W.B. 5-pin A.C.).
- 1 Variable trimming condenser, 0.0001 mfd. (Polar Volcon).
- 1 switch (Bulgin S.56).
- 3 L.F. chokes, 20 henrys (Pye).
- 1 L.F. choke, 32 henrys (Pye).
- Feed resistances in accordance with circuit diagram (Colvern Colvenstat).
- Centre tapped resistances can be used to feed to the H.F. stages.
- 3 H.F. chokes (McMichael Binocular Junior).
- 2 Decoupling resistances, 1,000 ohms (Groves).
- 1 Grid bias battery, 16 1/2 volts (Siemens).

- 1 S.G. cell, 0.9 volt (Siemens).
- 3 Tuning coils, 2-range incorporating wave-change switch and coupling condenser (Colvern T.G. 8.25 C.S.).
- 3 Cylindrical coil screens (Colvern T.G. 8.25 C.S.). Brass rod, 14 x 1/4 in., together with operating knob for ganging coil switches.
- 2 Ebonite shrouded terminals, marked "Aerial" and "Earth" (Belling Lee).
- 1 Bakelite panel, 11 x 9 x 3/16 in. (Hughes Trohitax).
- 2 Tubular valve shields (H. & B. Radio, 24, Beck Street, London, W.1.). Thin tinned plate for choke screening boxes, if these are not obtained ready made.
- 1 1/4 in. Brass tube, 1/4 in. (thin walled) for screening plate leads.
- 1 Aluminium base plate, 15 1/2 x 11 in., No. 16 S.W.G. (Cylton, Colvern, etc.), or piece of tinned plate.
- Hard-rolled aluminium sheet, No. 20 S.W.G. for making condenser shields, if these are not obtained with tuning condensers.
- 1 Geared condenser dial (Burnlept Ethovermier, No. 1151).
- 2 Spade ends.
- 2 Wander plugs.
- Plug adapter.
- Wood, screws, wire, systoflex, etc.

Approximate cost £14.

Battery Model with low voltage condensers £9 10s.

D.C. mains H.T. supply, and all D.C. mains operation. Several experimental receivers have been built following the first two circuits, and have given consistent results. The third, however, is more complicated, incorporates more expensive valves, and compared with the alternative process of charging an L.T. battery from a D.C. supply, is no more economical to run. All three types follow exactly the same layout above the base, while if the underbase arrangement of the feed components is followed there will be no stray couplings along the leads, the decoupling apparatus being right up against the point of through connection to the top panel. Only the H.F. chokes require to be accurately placed with regard to the location of the components above the base.

Constructional Hints.

In proceeding with the construction a start is made with the wooden base container. By purchasing planed white wood or mahogany time will be saved. Take every care to make corners exactly square, finishing with a medium file and glass-paper. All edges are glued and screwed. A flat sheet of hard rolled aluminium about 1/8 in. in thickness (No. 16 S.W.G.), such as is used for radio panels, can be obtained cut to size, with the edges finished square. As the aluminium sheet is to be held down by the components, it is only necessary to use a fixing screw at each corner. All screw heads appearing above the panel are nickel-plated, and one is reminded of the need to take care to avoid scratching the aluminium in the course of assembly. Stout tin plate may be used as a substitute for this aluminium cover. Preferably with the aid of dividers, accurately set out the valve-holder positions. Each valve-holder is then temporarily screwed down, and the positions of the four (or five) valve-holder terminals marked through on the aluminium, using a valve-holder stripped of its terminals as a template. Using a sharp 1/8 in. drill clean holes are made in the aluminium beneath every terminal, any burr being subsequently removed with the point of a larger drill. Guard against chips of aluminium remaining around the under side of the valve-holders. Before assembling the valve-holders, the screw terminals are reversed, with the exception of the grid connection, so that the screws project downwards through clearance

holes into the base box. Next, position the coil containers and secure the metal bases with a pair of countersunk screws prior to placing the coils in position. A fine hole drilled through later from the centre of the coil containers will indicate their position on the underside of the wooden base, and a circle may be subsequently

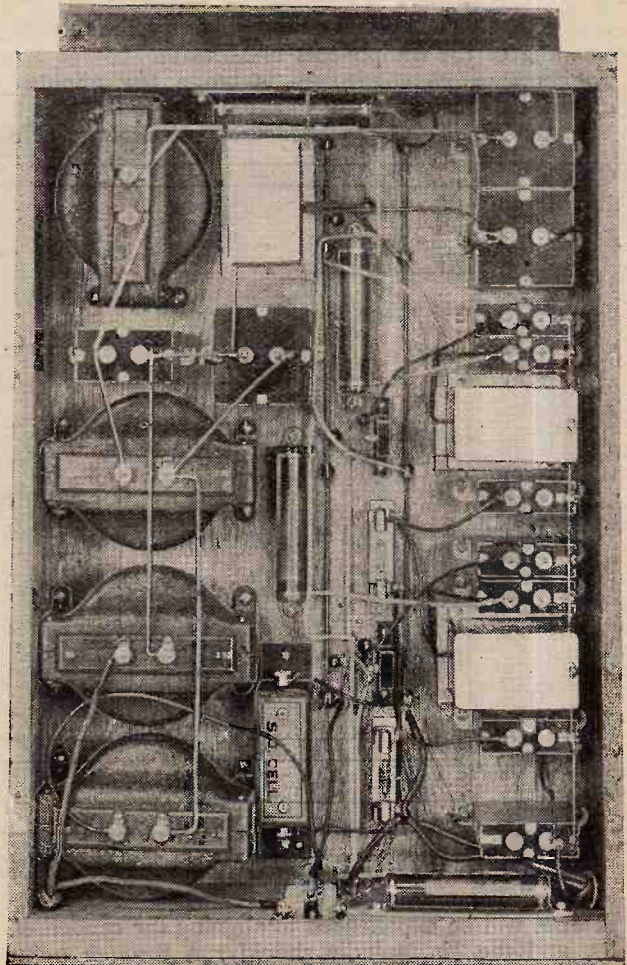

Underside view of a set wired for accumulator L.T. and D.C. eliminator H.T. supply. There is ample space for the components, and the positions of the chokes associated with the H.F. stages only are important.

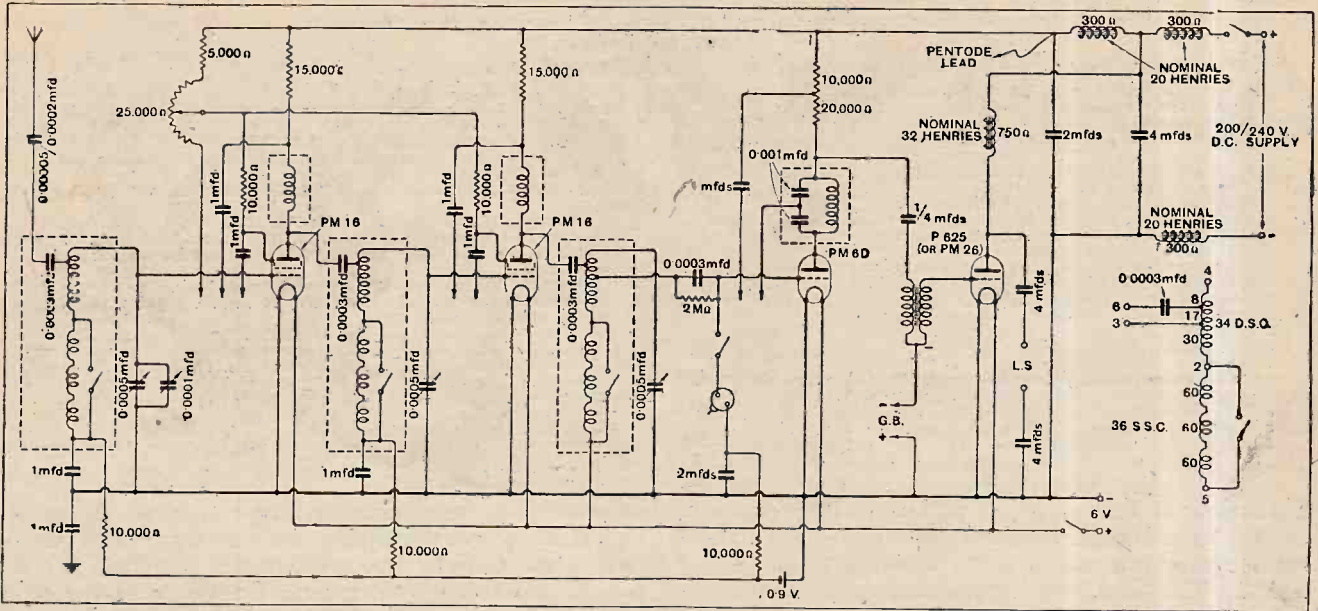

This circuit arrangement is best suited for D.C. supply and contains little complication. The resistance values may be retained with D.C. supplies of 200/240 volts.

swung on the wood to serve as a guide for the relative positioning of the components underneath.

To combine the condensers is but a few minutes' work, six rods being needed exactly similar to those used in the construction of the condensers themselves. No

at the back end also engaging on three fixing screws will be required. These parts, if necessary, can be readily obtained from the manufacturers of the condensers. Before permanently fixing the aluminium top plate in position, all fixing holes, as well as two fixing and two

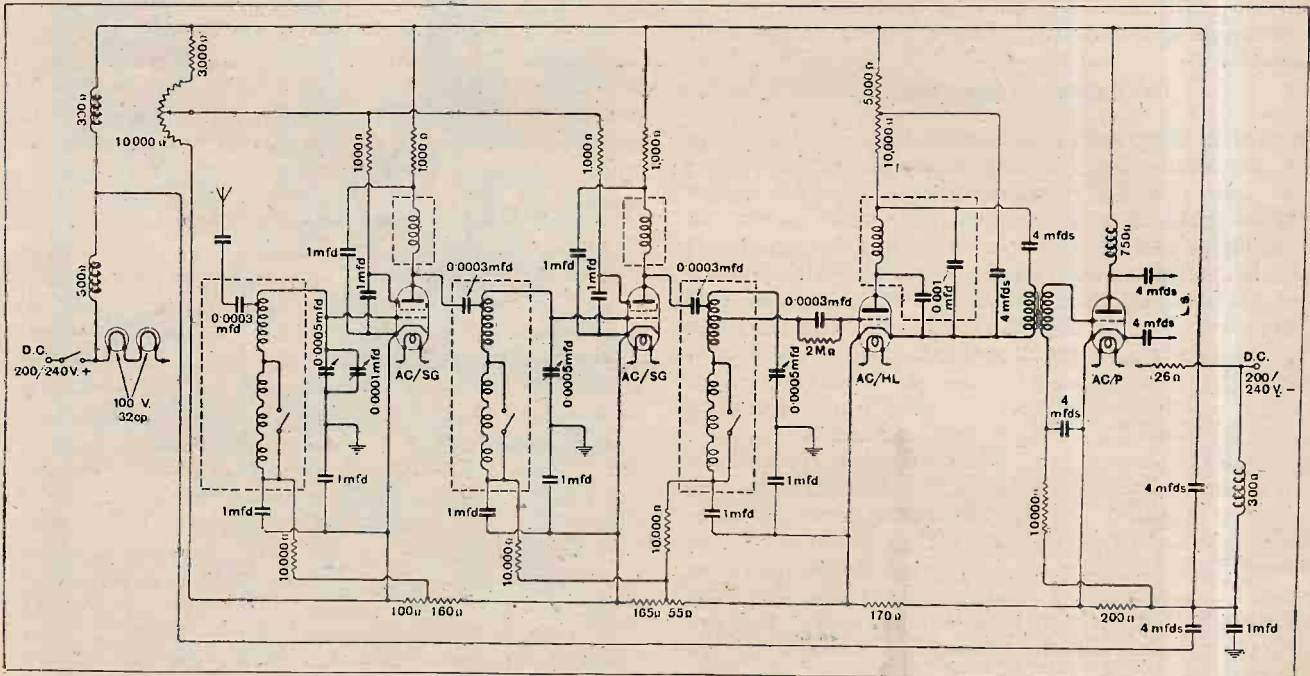

Circuit using indirectly heated valves and arranged for all-mains working from D.C. supply. The voltage regulating resistances provide grid biasing potentials and adjust the cathode potentials to that of the heaters.

difficulties will be experienced in aligning the condenser units, and the $\frac{1}{4}$ in. spindle should run through quite freely. While the front of the condenser is supported by a three-hole fixing to the panel, a supporting bracket

lead-out holes from each coil, should be made in order that any burr may be removed so as to allow the panel to be absolutely flat on the wood.

(To be concluded).

Aperiodic H.F. Amplification

The Effects of Negative Reaction.

By A. L. M. SOWERBY, M.Sc.

(Concluded from page 6 of previous issue.)



AT the end of the first instalment of this article attention was drawn to the fact that grid-circuit damping is a prominent feature of the aperiodic high-frequency amplifier. The fundamental reason for this is the existence of a small capacity between the grid and plate of the valve, which acts as a path through which the amplified voltages on the plate can be fed back to the grid. It can be shown by suitable mathematical methods¹ that the physical result attending this feed-back of amplified voltage depends primarily on the nature of the components connected in the plate circuit of the valve. If the impedance in the plate circuit is, on the whole, inductive, the energy fed back has such a relationship to the grid voltages that these are reinforced by it, and the signals applied to the grid are therefore strengthened. We have, in fact, the well-known condition of "natural reaction," which may, in an unfavourable case, rise to such magnitude as to induce spontaneous oscillation.

If, on the other hand, the impedance in the plate circuit is mainly capacitive in character, the amplified energy fed back through the plate-grid capacity

does the application of a reaction coil connected the wrong way round.

We saw, in beginning the discussion of the choke-coupled amplifier, that the anode circuit of the valve contained an inductive impedance (the choke itself) of some 500,000 ohms, in parallel with a capacity (the "stray" capacities) having an impedance of about 5,000 ohms. With so many inductive ohms and, by comparison, so few capacitive ohms, one might thoughtlessly conclude that "inductance has it," and that the plate circuit of the valve must be labelled as inductive.

Precisely the opposite is the case. Since we are discussing the effects due to the flow of the plate current—or rather, the high-frequency component of it—we must fix our attention not on the branch through which only a minute current flows, but on the branch which carries practically all the current. If the stray capacities have only about one-hundredth of the impedance of the choke, 99 per cent. of the current will flow through these capacities, and the plate current is very definitely capacitive on balance.

How a Frame Aerial is Affected.

In any aperiodic amplifier we must, therefore, expect to have to face a feed-back of energy through the valve in such a direction as to tend to damp out the signals that we are applying to its grid. When making the measurements of stage-gain that were quoted in the first half of this article, the voltage fed to the grid of the valve was produced in a manner which made it impossible for the valve to feed back energy enough to alter the input voltage by more than about one per cent. at the very outside. A tuned frame aerial, or an ordinary tuned circuit lightly coupled to an outside aerial, is very susceptible indeed to the effects of damping, whether arising from reverse reaction or any other cause, as the elaborate precautions necessary to obtain a "low-loss" tuned circuit bear eloquent witness. Some measurements were therefore made with the view of obtaining an idea of the extent to which a choke-coupled amplifying stage will damp a tuned circuit connected in its grid circuit.

For this purpose, the circuit of Fig. 1 was put together. It consisted merely of a single-stage, choke-coupled amplifier feeding its output into a second valve V₂. V₂ was not lighted in any of the measurements made; it was inserted into the holder only to ensure

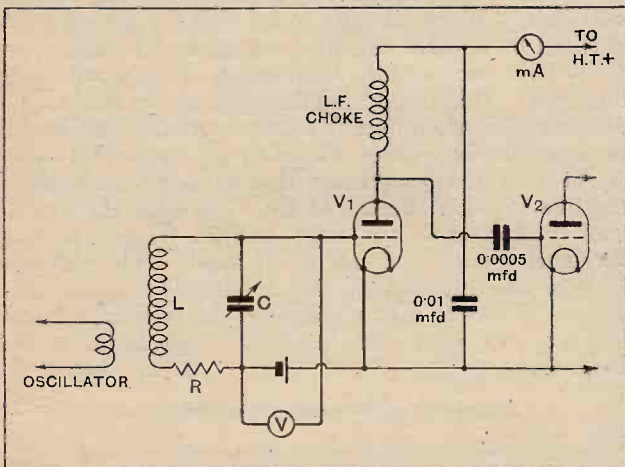

Fig. 1.—With the aid of the circuit shown here, the damping imposed by an aperiodic amplifier upon the tuned circuit connected to its grid was investigated. V is a valve voltmeter used to read the high-frequency voltages produced across LC by coupling to the oscillator coil.

of the valve tends not to reinforce, but to damp out, the signal voltage on the grid. In this case the valve is said to be providing "negative reaction," since it tends to kill the signals in exactly the same way as

¹ See, for example, *Experimental Wireless*, Sept., 1928, p. 509, or Peters, "The Theory of Thermionic Vacuum Tube Circuits," Chap. VIII (McGraw-Hill Book Co.).

Aperiodic H.F. Amplification.—

that the stray capacities connected to the plate of V_1 should be those arising in a practical set, and not greatly different in magnitude from those present when the stage-gain measurements already detailed were being carried out

As a preliminary, the tuned circuit was energised from an oscillator, and the coupling between the two adjusted until the valve voltmeter V , which reads the voltage developed across the coil, showed full deflection (about one volt). The filament of V_1 was lighted, but so far the H.T. lead had not been plugged in, so that the valve was not amplifying, although all the incidental losses due to connecting it and its holder across the tuned circuit were already present. On plugging the H.T. lead into the battery, the voltage read on V dropped instantly to zero and there obstinately remained in spite of frenzied retuning on C .

The original idea of making some rough comparative measurements of the voltage across the tuned circuit with and without V_1 in action was thus seen to be impossible, as the ratio of voltages was clearly greater than could be covered by the valve voltmeter, on which no voltage much less than 0.1 is comfortably detectable. The preliminary experiment has yielded the information that the voltage normally picked up by the coil L is reduced by the negative reaction effect to something less than one-tenth of its original value.

A more systematic mode of attack was then planned. Provision was made for the insertion (at R , Fig. 1) of a series of interchangeable resistances of fine wire, with the aid of which the approximate measurement of the

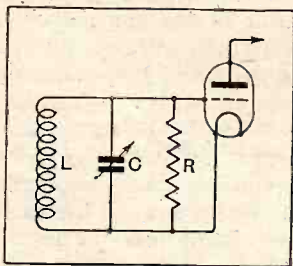

Fig. 2.—The damping introduced by negative reaction effects is expressed throughout by giving the value of the resistance which, connected as at R above, would produce the same effect on the tuned circuit.

of Fig. 1, but as being equivalent to a resistance connected across grid and filament of the valve in parallel with the tuned circuit, as suggested in Fig. 2. To check the soundness of this mode of expressing the results, the addition to the series resistance produced by connecting the amplifying valve was measured at 300 metres with two different coils connected in turn at L .

With a coil of inductance 260 microhenrys, the series resistance was raised from 13 ohms to 337, and with a 96-microhenry coil from 3.7 ohms to 48.6. The additional *series* resistance is very different in the two cases; the equivalent *parallel* resistance, connected as at R in Fig. 2, in both cases works out to 8,000 ohms.

It is thus clear that the results will be of much more general application if they are expressed in terms of equivalent parallel resistance, the figures for which are quite independent of the tuned circuit, rather than as series resistance, when the values would be correct only for the actual tuned circuit used for the measure-

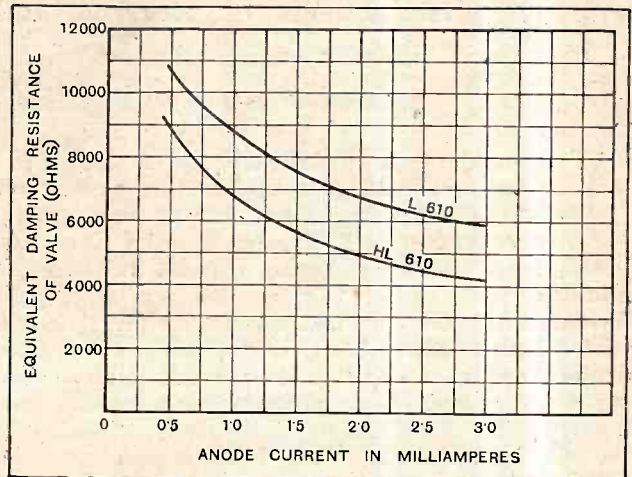

Fig. 3.—Equivalent damping resistance of amplifying valve. The grid circuit is damped, by negative reaction, to an extent equivalent to connecting in parallel with it resistances of the value given. The lower the resistance, the greater the damping and consequent loss of signal strength.

ment. It must, however, be carefully borne in mind that a *high* parallel resistance corresponds to *small* damping, and vice versa.

Still using the circuit of Fig. 1, a whole series of measurements of input damping was made, using the valves found most satisfactory from the point of view of stage-gain. It was at once found that the damping introduced by a valve at a fixed anode current was practically independent of the wavelength of the signal being amplified. This result would appear to be due to the interaction of two opposing factors. As the wavelength increases, the impedance offered by the anode-grid capacity of the valve gets greater, thus tending to reduce the negative reaction effect. At the same time the amplification afforded by the stage becomes greater, so that the signal voltage available at the anode of the valve to drive a current through the anode-grid capacity increases. Thus at any wavelength the resistance introduced by the valve into its grid circuit is about the same.

Damping of Enormous Magnitude.

Fig. 3 gives numerical values of the equivalent parallel resistances introduced by the L.610 and H.L.610 valves into the tuned circuit, and hold for any wavelength within the broadcast band. The lower the equivalent resistance, the greater is the damping effect, so that the H.L. valve flattens the tuning of its grid-circuit rather more than the L. valve, provided that both are worked at the same anode current. Since the plate-grid capacity of the two valves is probably about the same, this is to be expected, as for the same plate current consumption the H.L. valve gives greater amplification than the L. valve.

Aperiodic H.F. Amplification.—

Attention is particularly drawn to the enormous magnitude of the damping—that is to say, to the extremely low value of the resistance that is equivalent to the valve. If we remember that the dynamic resistance of quite a modest tuned circuit is in the neighbourhood of 150,000 ohms, the loss of signals produced by shunting this with so low a resistance as 6,000 ohms will begin to become manifest.

If we collect signals from the local station on a frame aerial, we shall find that connecting a choke-coupled amplifier in parallel with it in place of an anode-bend rectifier or a high-frequency stage of normal design will reduce the high-frequency voltage induced in the frame to about one-fiftieth of its original magnitude. The meagre amplification, provided by the choke-coupled stage, amounting at most to about eight times, will not nearly make up for this tremendous drop, so that on balance the amplifier *reduces* the signal voltage to about one-sixth of the amplitude that could be had by connecting the frame directly to the next valve of the set.

The Screen-grid Valve as Aperiodic Amplifier.

Actual curves for the two best valves examined are given in Figs. 4 and 5. These are calculated on the assumption that the choke-coupled stage follows a frame aerial—after which such a stage is generally used—and that the frame has a dynamic resistance of 150,000 ohms at all wavelengths. This figure, for a competently designed frame, is low rather than high, so that the overall amplification curves err on the side of optimism. Reference to the curves will show that at 500 metres the best that the choke-coupled stage can do is to

discarded as being unutterably tedious to use. Without the amplifier, even a 200 to 1 reduction gear had to be handled gingerly if accurate measurements were wanted.

In a practical receiver, of course, things are not nearly so bad as they have here been made out. Not that the

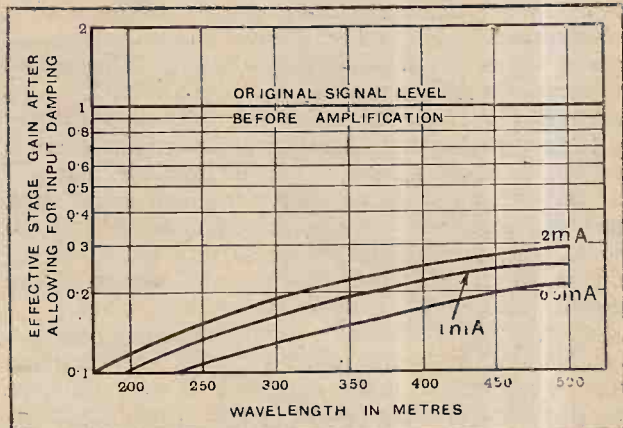

Fig. 5.—Effective stage-gain of choke-coupled stage, after allowing for damping of input tuned circuit. The valve is an L610.

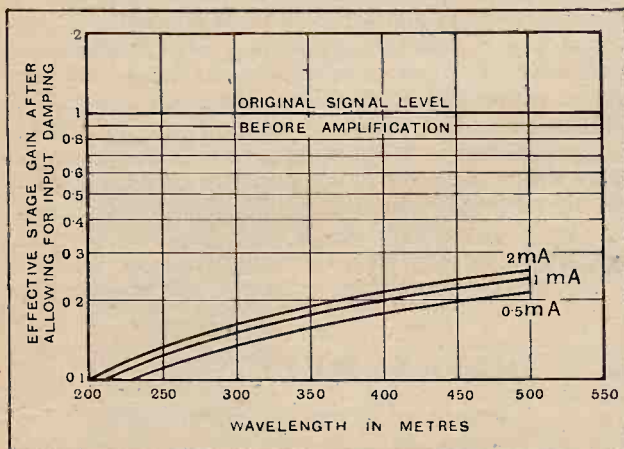

Fig. 4.—Effective stage-gain of choke-coupled stage, after allowing for damping of input tuned circuit. The valve used was an HL610.

liver just under 30 per cent. of the voltage that could have been had if the so-called amplifier had been omitted. At 200 metres this figure drops to 10 per cent. only.

Concurrently with this drop in signal voltage there is a heavy loss of selectivity. This was very noticeable when making the measurements of the resistance of the tuned circuit; when the choke-coupled stage was put into action the slow-motion drive on the condenser was

damping described does not take place—it does, unless the stage stops amplifying—but its evil effects are counteracted by reaction into the tuned circuit LC of Fig. 1. If we compare results with and without the aperiodic amplifier on the understanding that in both cases reaction is to be applied to the frame until a standard sharpness of tuning is attained, then the deliberate positive reaction compensates exactly for the negative reaction inherent in the amplifier, and the signal voltage across the frame is brought up again to its original value. On this understanding the full amplification, as measured and published in the first instalment of this article, is effective, and for the same quality of reception the signal voltage is some six times greater than it would have been if the amplifying stage had not been interposed between frame and detector.

The necessity for introducing reaction in this way, however, rather spoils the delightful simplicity of the aperiodic amplifier, for reaction control is always very critical indeed when applied to such a very high-resistance circuit as the heavily damped frame aerial becomes. It would, in fact, probably be less difficult to handle the extra tuning control of a tuned stage of normal design which, besides giving anything up to twenty times the amplification of the aperiodic stage, would make a welcome addition to the selectivity of the receiver of which it formed a part.

It has already been stated that the energy required for the input damping is transferred to the grid circuit through the grid-plate capacity of the valve. Why not use a screen-grid valve and avoid this damping altogether?

Pursuing this, a Mazda 215 S.G. valve, chosen for its exceptionally efficient internal screening, was put into the position of V_1 in Fig. 1, and the input damping was measured. As expected, the damping found was small, and was about equivalent to connecting a 150,000-

Aperiodic H.F. Amplification.—

ohm resistance in parallel with the tuned circuit; that is to say, the damping was about one-twentieth of that found with the triodes. It is probable that if metallic screening had been used to cut out the last remaining traces of capacity between the components in plate and grid circuits, and from the plate of the valve itself, the damping would have been reduced still further.

Measurements of amplification were also made, using various values of anode current as before. Throughout the series the grid-bias was kept constant at $1\frac{1}{2}$ volts negative, the anode current being controlled entirely by varying the screen-grid voltage. The results of these measurements are shown in Fig. 6, from which it will be seen that, apart from negative reaction, there is not much to choose between this valve and the best of the triodes. (If valve makers were to turn out a screen-grid valve of characteristics designed for aperiodic amplification, there might be another tale to tell.)

Fig. 7, however, in which input circuit damping has been allowed for on the rather generous scale that the rough measurement made suggested, is very different from the corresponding figures (4 and 5) relating to triodes. Here, for the first time, we have found an aperiodic stage which will amplify without the need for reaction to help it.

If reaction is to be incorporated in any case, there is not very much point in choosing a screen-grid valve instead of a triode for aperiodic amplification, except on the score that the reaction control is likely to be smoother and more easily handled when it has only a small amount of damping to overcome. In any receiver where a real "no-control" H.F. stage is wanted, however, a screen-grid valve offers the only possible solution to the difficulty.

All the remarks so far made apply primarily to re-

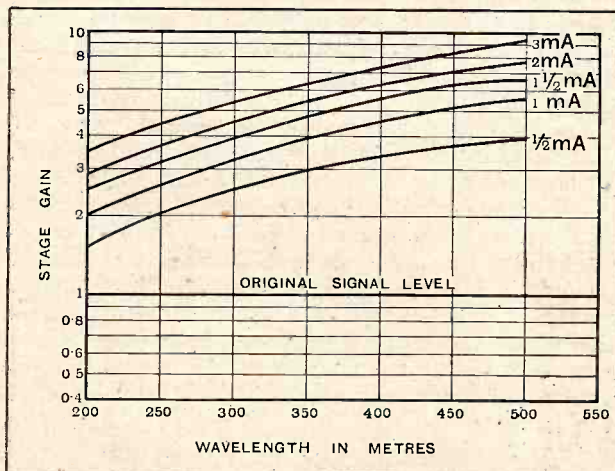

Fig. 6.—Stage-gain from choke-coupled stage employing Mazda 215SG valve, for various values of anode current.

ceivers in which there is but a single stage of aperiodic amplification; with more stages the input damping still exists, but incidental and accidental reaction, as well as the modifying effect that each stage has on the one that precedes it, may partially or completely nullify the damping—or even bring about the reverse effect, spon-

aneous oscillation. The simple rule that a capacitive plate circuit damps, and an inductive plate circuit energises the frame aerial is complicated by so many in-calculable factors in a multi-stage set that almost any-

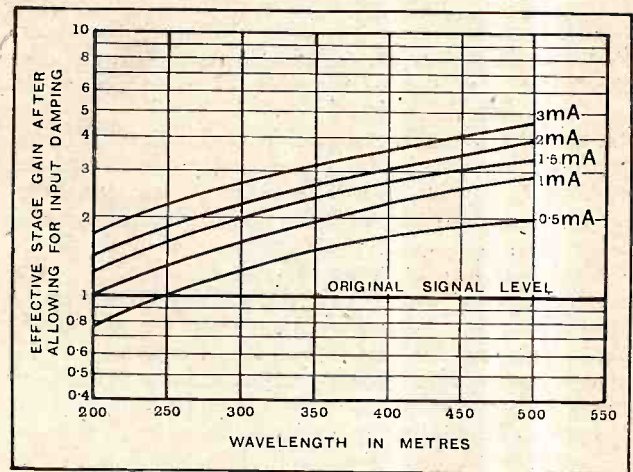

Fig. 7.—Stage-gain, after allowing for damping of input circuit, to be expected from Mazda 215SG valve as choke-coupled amplifier. Compare with Figs. 4 and 5.

thing may happen. As an example of this, the writer would recall that, in a review of one of the models of the Loewe two-stage valve,² which incorporates two stages of resistance-coupled, high-frequency amplification, it was found that the two stages, taken together, left the frame aerial to which they were connected with the same resistance that it had with the valves unlighted. Later experience, using three such valves in cascade (six stages), has shown that there is sufficient feed-back in a poorly screened amplifier to produce oscillation unless precautions are taken to avoid it. The feed-back is capacitative in nature, and appears to arise from the exposed wiring and the anodes of the last valve or two in the series. The point, in itself, is not important, but is mentioned in order to indicate that the problems arising when a number of stages are to be used in cascade are of a very much higher order of complication than the comparatively simple ones presented by the single stage that has been the subject of this article.

² *The Wireless World*, August 21st, 1929.

o o o o

BOOKS RECEIVED.

Electrical Wiring and Contracting. Vols. VI and VII. Edited by H. Marryat, M.I.E.E., M.I.Mech.E.—Volume VI comprises Electric Lifts; Lamps and Illumination; House and Office Telephones. Volume VII comprises Radio Installation Work for hospitals, lecture halls, and public buildings; Industrial installation work; Theatre and Cinema installation work. With numerous diagrams and illustrations. Published by Sir Isaac Pitman & Sons, Ltd., London. Price, each volume, 6s. net.

Der Bau von Anoden- und Heizstrom Netzanschlussgeräten. By Manfred von Ardenne.—A short treatise on the principles and construction of H.T. Battery Eliminators. Pp. 78, with 95 illustrations and diagrams. Published by Rothgiesser und Dising, A.G. Berlin. Price R.M.1.70.

Speed and How to Obtain It. By J. E. G. Harwood, B.A., M.I.M.T.—Third edition, largely rewritten in the light of the very latest developments in motor cycle practice. Pp. 188, with 136 illustrations and diagrams. Published by Iliffe & Sons Ltd., London. Price 2s. 6d. net. By post 2s. 9d.

TELEVISION ON THE SCREEN

ONE of the lines of progress in television development is that of producing an image of sufficient size that it can be seen by an audience in place of the but tiny images hitherto obtained and limited in size by the dimensions of the plate of the neon tube. To increase the size of the image necessitates the substitution of the scanning disc by a rotary switch sweeping across a number of contacts connected to a screen built up from a large number of lamp units. Such an equipment was recently demonstrated by the Baird Company, an important feature being the use of metal filamented lamps to compose the screen in the place of neon lamps or a multi-electrode neon tube such as was adopted in the Alexanderson apparatus in America. No fewer than 2,100 lamp units are used in the construction of the screen, each representing a point of light about $\frac{3}{4}$ in. square and producing an image 2ft. wide and 4 to 5ft. in height. Each lamp is connected to a segment of the large rotary selector switch, and although these segments are only about $\frac{1}{32}$ in. in width, the ring of the switch is nearly 3ft. in diameter. A light arm sweeps round on the switch segments and coupled to the shaft of the driving motor is the customary toothed wheel synchroniser, though of somewhat larger dimensions than the type fitted to the small home television receiver. Six generous power output valves of the D.O.60 type control the synchroniser, while nine similar valves are used to produce the image.

Well Illuminated Image.

A considerable increase in anode current is required to illuminate the filaments in view of the brief time for which the current is applied. It is understood that the average current instantaneously passed by the lamps in succession is of the order of 5 amperes, although the normal current required for steady lighting of a single lamp is only 0.2 ampere. A ground-glass screen covers the lamps so as to give uniform illumination of the squares.

A particularly bright image was produced, and although the lamps glow for a longer interval than the time of application of the current there was no blurring. Good definition was produced between light and shade though the image was expressively

Demonstration
with
Large Image
at
the Baird
Laboratory.

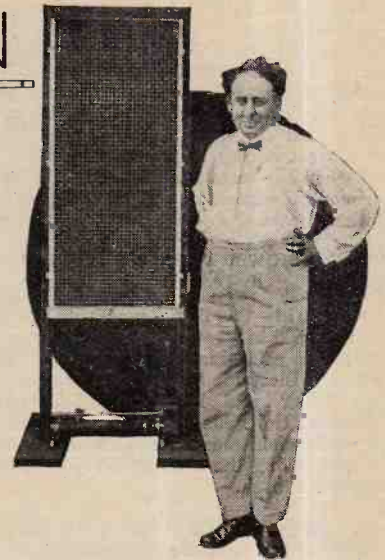

harsh and rather lacked half-tone. Viewed at a distance of less than 20 feet the flashing lamps could be seen individually, and as the screen was not seen as a whole the image could not be identified. As the distance away from the screen increased the quality of the picture improved, and when 50 feet away it became quite easy to identify the faces of the various artists as they appeared on the screen. Exaggerated contrast, due to lack of half-tone, gave rise to heavy black shadows across parts of the image, though the illumination was fairly uniform and possessed little flicker, except that due to a rocking of the image owing to synchronising difficulties.

This demonstration was stated by the Baird Company to be a prelude to the transmission of television to the cinema theatre not only for conveying current events, but ultimately to replace the circulating of films. Considerable progress will be necessary before such an undertaking will reach sufficient perfection to entertain the public.

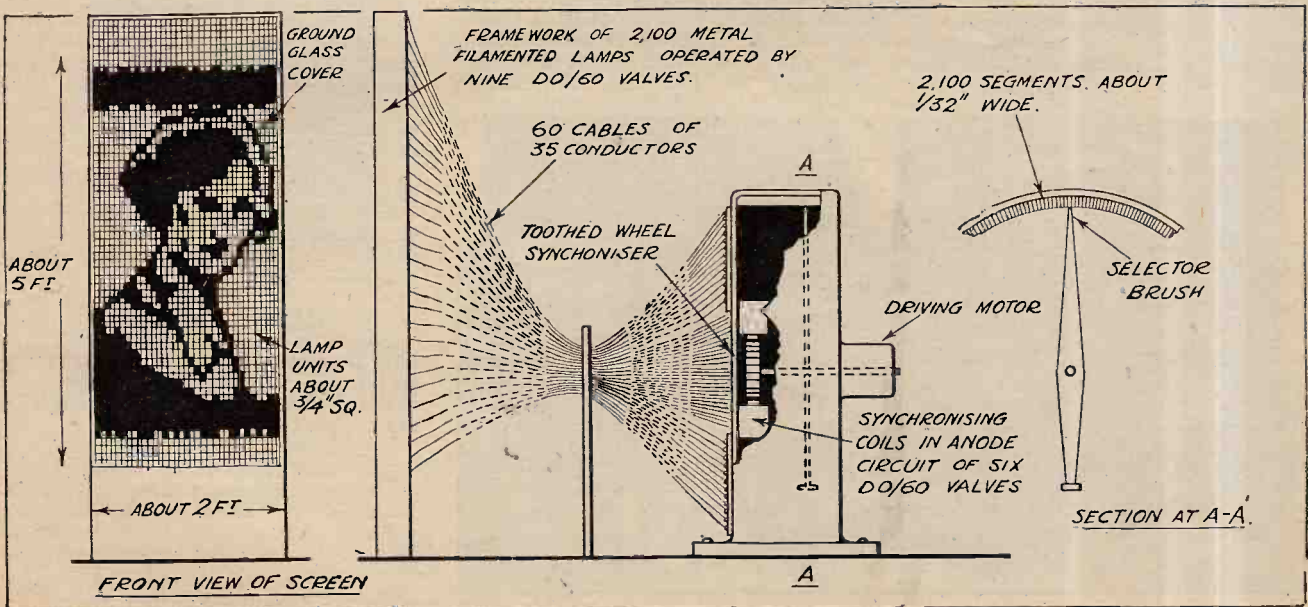

The synchronised switch with 2,100 segments controls the lighting of small lamps forming the screen.

TELEPHONING FROM BRITISH TRAINS.

The Southern Railway's famous "Golden Arrow" express may shortly carry two-way telephone equipment operated on the wired-wireless system. A representative of the International Pullman Company informed *The Wireless World* that the question is being studied by the company's engineers, and that, if and when the tests are conducted, the experimental apparatus will be installed on Pullman cars.

○○○○

500-KILOWATT BROADCASTING TESTS.

The most powerful broadcasting station in the world—WGY, Schenectady, operating with 500 kilowatts—may soon have an equivalent at Oakland, California. The General Electric Company, owners of both WGY and KGO, Oakland, have petitioned the Federal Radio Commission for permission to experiment with the two stations, using the same power and wavelength for each.

○○○○

AN AMATEUR IN THE ATLANTIC.

Braving the Atlantic in a 19ft. cutter in which he hopes to reach New York is a French wireless amateur, Joseph Macedo, who recently sailed from Casablanca. He is equipped with a short-wave transmitter, says our Paris correspondent, and uses the call sign XCNP. His schedule is as follows:—9.30 p.m. (GMT) on 41.5 metres; 10.30 p.m., 36.5 metres.

Power is derived from two 90v. dry batteries, and the aerial consists of a 20ft. wire stretched vertically to the top of the mast. Paris amateurs have reported good signals in spite of the tossing of the boat.

○○○○

NO BARRIERS FOR WIRELESS.

Wireless will shortly penetrate the forbidden country of Tibet, according to a report received from Shanghai by the U.S. Department of Commerce. Ten wireless telegraph stations for inter-communication are to be distributed throughout Tibet besides Inner and Outer Mongolia.

Current Topics

Events of the Week in Brief Review.

IN ROME, TOO.

The Governor of Rome has issued an order prohibiting the use of loud speakers outside shops.

○○○○

RENEWING NORWEGIAN TRANSMITTERS.

A reorganisation scheme for Norwegian broadcasting, now under consideration, involves an expenditure of £250,000 for transmitters and other equipment.

○○○○

CHEAP TRAVEL FOR W/T OPERATORS.

Wireless operators, as well as all ranks of the merchant navy, can now obtain return tickets on any British railway at the rate of a single fare and one-third. This concession has been obtained by marine unions and the Association of Wireless Telegraphists.

○○○○

WIRELESS AND NEWSPAPERS.

Editors of the future will receive their news, advertisements and pictures entirely by wireless, according to the predictions of Mr. Frank Stockbridge, a veteran journalist of Milwaukee, who recently

addressed the U.S. National Editorial Association. He also prophesied that subscribers would receive their journals by wireless, the pages being reproduced on sensitised paper.

○○○○

TOULOUSE CHANGES WAVELENGTH.

To avoid interference from Poland, Radio Toulouse has raised its wavelength from 381 to 384.4 metres.

○○○○

AN ESSENTIAL SUBJECT.

The course in Industrial Electricity at the Paris Conservatoire of Arts and Crafts now includes full tuition in wireless.

○○○○

MODEST PROGRAMME COMPILERS.

"Do you use radio reception as a background to other activities?" is a question in a programme plebiscite which is being taken among Australian listeners.

We presume that the authorities are anxious that the programmes shall not be unduly obtrusive when the family is taking a nap or playing shove ha'penny.

○○○○

MARCONI WIRELESS DIVIDEND.

The directors of Marconi's Wireless Telegraph Co., Ltd., have decided to recommend to the shareholders at the annual general meeting to be held on July 14th the payment of a dividend of 15 per cent., less tax, on the ordinary shares of the company for the year ended December 31st, 1929, and an additional dividend of 5 per cent., less tax, on the seven per cent. cumulative participating preference shares for the same year.

○○○○

LAST WORD IN AMPLIFIERS.

The very latest design in amplifying equipment was used for the first time with the Marconiphone loud speaker installation at the R.A.F. Display, Hendon, on June 27th. A photograph appears on this page. In the main amplifier one MT.9L transmitting valve took the place of the 1B0 or more LS.5A valves used last year. The amplifier itself is one of the new type 700—1½ kW. equipments. It is entirely enclosed and protected by safety gates, other features including an overload relay which, on a persistent heavy blast, closes down the amplifier entirely, and a push-button start.

The desk-type twin turntable unit for gramophone-record reproduction incorporates the first-stage amplifier in a pedestal cupboard.

○○○○

"TANNOY PRODUCTS."

The above is the new title of the Tulsemere Manufacturing Company, 1-7, Dalton Street, W. Norwood, S.E.27, makers of the well-known Tannoy mains units and other electrical apparatus.

○○○○

THE BAND-PASS FOUR.

Two typographical errors occurred in the article on "The Band-Pass Four" in our issue of June 25th. In the caption to Fig. 1, p. 662, the capacities of the balancing condensers, C₄, C₆, C₁₃, C₁₇, C₂₃, should be 0.0001 mfd. max., instead of 0.001. In addition, the value of the resistance R₂ should be 500,000 ohms (0.5 meg.), not 50,000.

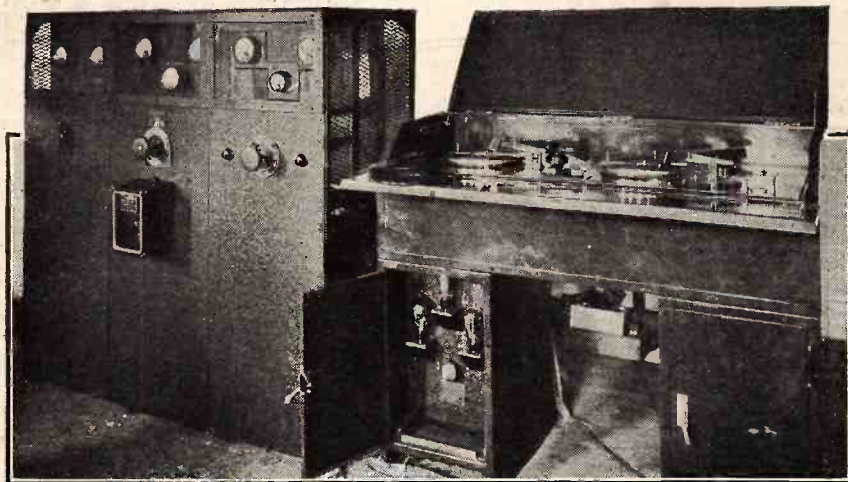

A COMPACT AMPLIFIER. The new Marconiphone 1½ kW. type 700 amplifier described on this page. On the centre panel of the amplifier can be seen the overload relay which, on a persistent heavy blast, automatically switches off the apparatus. The twin turntable unit incorporates the first-stage amplifier.

WIRELESS WORLD



LABORATORY TESTS

A Review of Manufacturers' Recent Products.

VARLEY L.T. L.F. CHOKE.

As its designation implies, the function of this choke is to smooth out ripple in the filament supply when this is derived from any but an accumulator source. As an example one might cite cases where this is drawn from the A.C. mains, using a step-down transformer and a rectifier, or it would be permissible to employ this choke to smooth out ripple from the D.C. mains when the filament current is derived from this source.

The D.C. resistance of the winding is 0.5 ohm., and its carrying capacity 3 amps. Needless to say, the inductance is comparatively low, and consequently the choke should be used in conjunction with large-capacity condensers to give the required smoothing of the L.T. supply. The electrolytic type is recommended by the makers for this purpose.

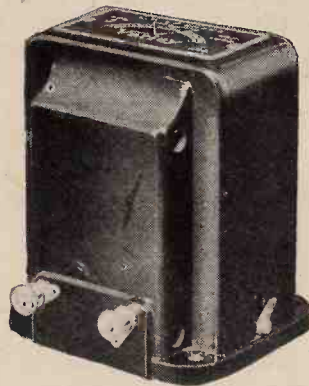

Varley L.T. smoothing choke.

The price is 20s., and the makers are Varley, Kingsway House, 103, Kingsway, London, W.C.2.

o o o o

POLAR TUNING GRAPH.

Readers who are contemplating calibrating their receivers will be interested to learn that a useful chart for this purpose is now being marketed by Messrs. Wingrove and Rogers, Ltd., Arundel Chambers, 188-9, Strand, London, W.C.2. The chart, which is printed on stout cardboard, measures 9½ in. x 10½ in., and is divided into large squares, each 1 in. square, and these are subdivided in

100 small squares, each subdivision being 1/16 in. square.

The horizontal base line is marked 0-180 to correspond with the condenser dial divisions, while the abscissæ form the

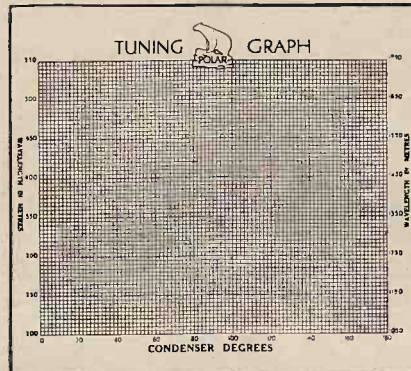

Polar tuning chart suitable for use when calibrating a receiver.

wavelength scale. The left-hand margin is marked 200 to 550 metres, and the right-hand margin is divided between 1,050 and 1,750 metres, being intended for the long-wave calibration. These charts, which are provided with a cord for hanging on the wall of the wireless room, cost 2½d. each. The back of the chart contains full instructions regarding the method of preparing a graph, and how to make the best use of one when prepared.

**FERRANTI LOUD SPEAKER.
A.C. Model.**

This loud speaker is marketed in the form of a self-contained unit in which are incorporated a mains transformer and U8 full-wave rectifier for energising the field magnet winding. The transformer has a tapped primary, which can be adapted to mains voltages between 200 and 250 and frequencies from 40 to 100 cycles. The power taken from the mains is 35 watts in the case of the A.C. model, and 23 watts for the D.C. model.

The average impedance of the moving coil over the whole frequency range is 20 ohms, and an external transformer is necessary to couple the loud speaker to the output valve. The instruction leaflet gives full particulars of the ratio required to match the output valve impedance.

The diameter of the diaphragm is rather

less than the average, and is only 6 inches. The coil is centred by a flexible "spider" attached to the centre core of the magnet.

Due no doubt to the small diameter of the diaphragm, the high-frequency response is extraordinarily good, and is, in fact, better than any loud speaker we have so far tested. The highest frequency tested was 6,000 cycles, but there is evidence that the response is good up to 8,000 cycles. The latter frequency can be usefully employed in radio reception, but would probably have to be sacrificed when reproducing gramophone records in order to keep needle-scratch within reasonable bounds. The bass register is free from objectionable resonances and "booming," and the middle register is uniform.

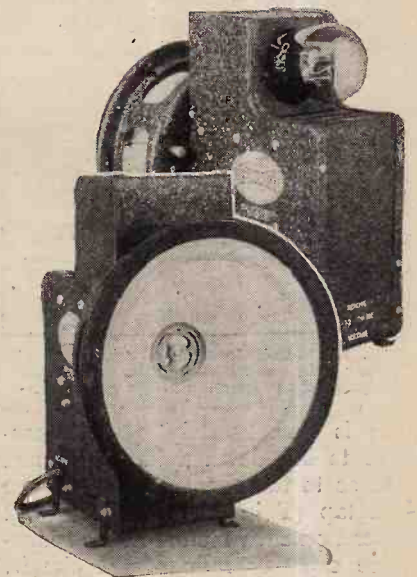

Ferranti Type S.A.I. moving coil loud speaker for A.C. mains.

The sensitivity is of the same order as the average moving coil, and, taking into consideration the performance as a whole, it can be stated with confidence that the Ferranti electro-dynamic speaker is one of the best three loud speakers commercially available at the present time.

The price of the A.C. model is £10, and there is a D.C. model available at £6 10s.

PRACTICAL HINTS & TIPS

POWER GRID DETECTION.

In this section of *The Wireless World* for June 18th, some of the advantages of "tapping down" the grid connection of the grid circuit detector were touched upon, and it was pointed out that by joining the rectifier across something less than the total inductance, the selectivity could be improved without any loss of signal strength—sometimes, indeed, with an actual gain in that direction. It might have been added that this procedure is likely to confer even greater benefits when dealing with a power grid detector (as discussed in *The Wireless World* for May 7th). Although damping due to this form of rectification is hardly as serious as is popularly believed, the fact remains that it does throw quite a heavy load upon the preceding tuned circuit; as stated in the paragraph already referred to, damping of this sort can admittedly be largely offset by the judicious application of reaction, but this is by no means a complete cure.

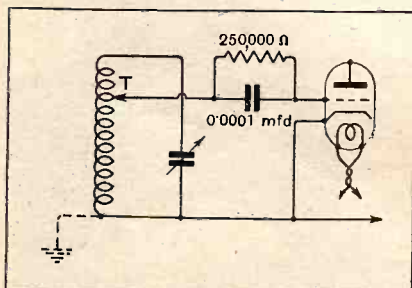
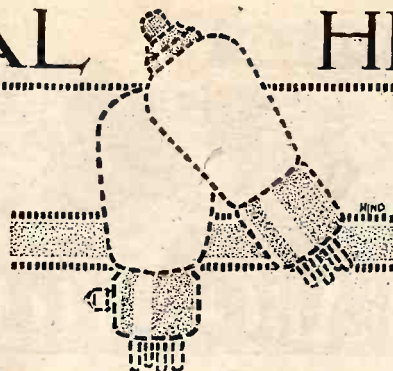

Fig. 1.—Circuit loading—a drawback of power grid detection—may be reduced by tapping off a proportion of the total available signal voltage.

It is unfortunately quite impossible to lay down a hard and fast rule as to the exact position of the grid tap (T in Fig. 1). This will depend on such factors as the inductance capacity ratio of the circuit, the H.F. resistance of the coil, on the characteristics of the particular detector valve used, and on its operating conditions. As applied to a practical receiving circuit the principle would, strictly speaking, involve the use of a number of tapping points to be changed when receiving signals on different parts of the tuning scale.



Simplified Aids to Better Reception.

Fortunately, however, academic accuracy is quite unnecessary, and under average conditions the tapping should be made to a point that will include from one-half to two-thirds of the total number of turns. Where extreme selectivity is important, it is safe enough to make the connection to the centre point of the coil, provided, at any rate, that its H.F. resistance is fairly low: if its normal losses are on the high side, the tap should be moved nearer to the high potential end of the winding, and *vice versa*.

It tends to complicate construction, particularly in a receiver with waveband switching, if provision is made for "tapping down" on the long waveband as well as on the medium broadcast range; and, except in cases where the listener depends largely on long-wave transmissions, it is unusual to add this complication. But if it is decided to include it, it should be remembered that, due to the high ratio of inductance to capacity in long-wave circuits, it will generally be necessary to make the tap at a point still farther remote from the high-potential end of the coil.

It seems that the throttle-controlled Hartley reacting detector circuit, when used in conjunction with power grid detection, might well be given a new lease of life, because it so happens that with this particular arrangement the detector grid circuit is perforce connected across one-half of the total inductance. A receiver planned on these lines is particularly likely to appeal to those who normally require a high-quality set for local broad-

casting reception, but at the same time do not wish to be debarred from occasional excursions farther afield: it is a fact that this circuit arrangement, thanks to the excellence of its reaction control, and to the fact that a large capacity can be maintained between detector anode and filament, is highly sensitive, even though it is not preceded by a high-frequency amplifier—which, incidentally, can easily be added.

Connections for a Hartley-cum-power grid detector combination are given in Fig. 2; the aerial connection, which may be conventional, is omitted, because, as already stated, there is no reason why a preceding H.F. amplifier (for which a tuned-grid choke-feed coupling is suggested) should not be used. As a rule, the feed capacity, F.C., which may be in the form of a neutralising condenser, should be mounted

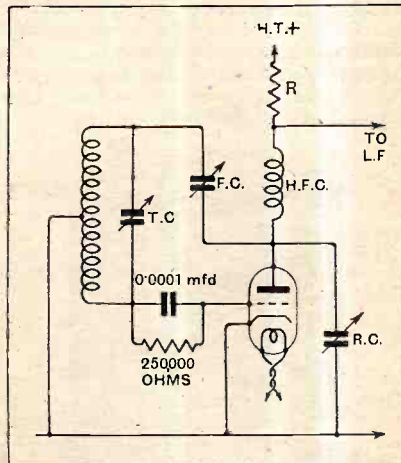

Fig. 2.—A new application of an old principle: the throttle-controlled Hartley circuit works well with a power grid detector.

in a fairly accessible position, the reason being that in a receiver from which high quality reproduction is to be expected, it is generally desirable to work without reaction when receiving local transmissions, and accordingly to set this condenser at minimum capacity, adjusting the reaction condenser, R.C., to a value determined largely by considerations of quality and detection efficiency. It will be realised that when F.C. is completely disconnected, the reaction condenser—which, by the

Practical Hints and Tips.—

way, may have a capacity of 0.0005 mfd.—is inoperative as far as its normal function is concerned.

Referring still to Fig. 2, it will be realised that R is the feed resistance used in conjunction with a parallel-feed system of L.F. transformer coupling, which is particularly suitable for sets with power-grid detection, and which was included in the Power Pentode Two, described in *The Wireless World* for May 7th and 14th. For the general considerations involved in the design of a receiver of this class, the reader is referred to these articles.

o o o o

AN INFALLIBLE RULE.

It is always useful, when attempting to locate a fault, to have a few rules as guidance. But, unfortunately, receiver circuits are of almost infinite diversity, and the trouble is that very few of the rules that can be formulated will hold good in more than a few specialised cases. There is, at any rate, one exception to this; it can invariably be assumed that there should be electrical conductivity between grid and cathode and between anode and cathode of every receiving valve circuit, and the non-existence of a path for D.C. current indicates a

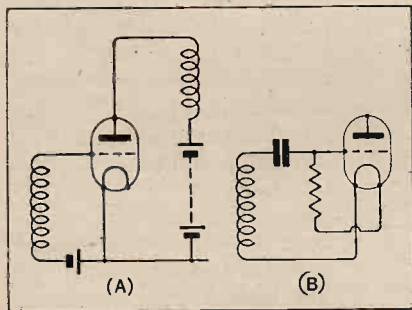

Fig. 3.—There should always be a conductive path between anode and filament and grid and filament in any valve circuit, although in the case of a grid detector (diagram B) the circuit resistance will be high.

definite fault in the circuit concerned. Of course, the converse does not hold true, as a short-circuit, through which continuity would be indicated when making a test, might be as harmful as an interruption in the circuit.

Unfortunately, the circuits with which we are concerned here are seldom perfectly simple and straight-

forward, and the operation of making a test for their continuity is generally obscured by the fact that in most of them a source of voltage—either a battery or eliminator—is included. Taking the example given in Fig. 3 (A), we see that the grid cathode circuit is completed through a bias cell, while an H.T. battery is similarly interposed between anode and cathode. The matter is further complicated by the fact that the D.C. resistance—and it is mainly with D.C. resistance that we are concerned when making these tests—of the working load in the circuit varies widely from valve to valve, ranging from, perhaps, something less than an ohm in the case of a short-wave grid inductance coil, to hundreds of thousands of ohms in series with the anode of an L.F. magnifying valve, and even to leak resistances in the order of megohms in detector-grid circuits.

It seems then, in spite of the apparent simplicity and straightforwardness of the rule that has been formulated, that it will not be too easy a matter to apply by using measuring instruments, as the sensitive meters required to indicate continuity through those circuits which include very high resistances would be damaged by connecting them between anode and filament of a valve with a high applied H.T. voltage and a load of low ohmic resistance: several different types of instrument might be needed for testing the circuits of a single set. This is true enough, but it is, at any rate, of some value to remember that the rule exists, and, applied with commonsense, it can often be helpful in tracing a fault.

In dealing with a grid circuit detector where the conductive path is *via* a leak resistance which is normally connected to the positive filament socket, it is well to remember that the valve must be *in situ* while the test is being made, or otherwise results of a test may be misleading.

It is probable that one can turn the rule in question to best account, when endeavouring to make a quick test, by using a pair of phones in series with a dry cell battery of a few volts, and a limiting resistance, to prevent the flow of excessive currents when tests are being made

across anode circuits. An arrangement of this sort is shown in Fig. 4. It will be safe enough to use a resistance of 100,000 ohms, although it is as well to make provision for connecting a much higher resistance when dealing with circuits with high voltages: by doing so, disconcerting “crashes” in the phones can be avoided. A warning should be offered at this point

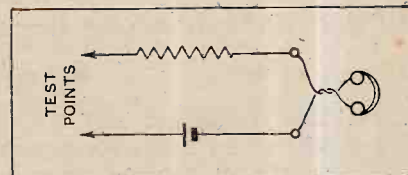

Fig. 4.—A phone tester with safety resistance.

against using phone testers in anode circuits where really high voltages are dealt with; in such cases it is best to disconnect the source of high tension supply and to short-circuit H.T. positive and negative terminals of the receiver.

THE MAINS TRANSPORTABLE.

The self-contained or portable receiver has a not-altogether undeserved reputation among knowledgeable amateurs as being deficient in the matter of quality of reproduction. It has been observed that there is a tendency to judge the mains-fed transportable set on the same basis. This is a mistake; lack of power in the output valve anode circuit is the principal controlling factor in the case of battery-fed sets, but there is no reason why the designer of the mains-driven self-contained set should limit himself unduly in this respect.

Consequently, self-contained mains sets and “open-aerial” receivers can be judged on an almost equal basis, although the objection is sometimes urged against the former type of set that its quality of reproduction suffers by virtue of the fact that its loud speaker must of necessity be small, so that it can be accommodated in the container. This objection does not seem to be altogether valid, but in any case, it can be overcome in a very practical way by making a two-unit receiver—the set proper in one container, and the loud speaker and power unit in another.

WIRELESS THEORY SIMPLIFIED

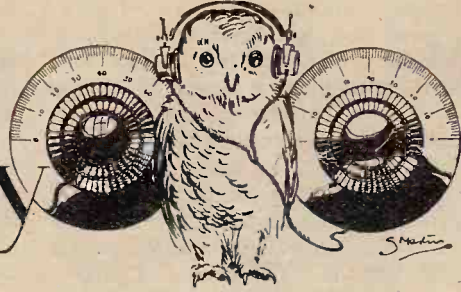

By S. O. PEARSON,
B.Sc., A.M.I.E.E.

Part XXXVI.—H.F. Resistance and its Effect on Selectivity.

(Continued from page 24 of previous issue.)

HAVING given a general outline of the sources and nature of the losses which occur in the coil and condenser of a tuned circuit, we are now in a position to consider the effects of the high-frequency resistance on the selectivity and voltage magnification as the coil is tuned to various wavelengths or frequencies by varying the capacity of the tuning condenser.

In dealing with tuned circuits in Parts XIII to XVIII of this series, it was assumed that the effective resistance of the circuit remained constant over the range of frequencies involved. But, although we now know that the resistance increases considerably as the frequency rises, the previous assumption of constant resistance did not result in any serious error as far as the resonance curves were concerned. This is because they were plotted for variation of frequency with fixed tuning constants, inductance, and capacity—that is to say, the circuit was tuned to one definite frequency given by $f_0 = \frac{1}{2\pi\sqrt{LC}}$ cycles per second.

Only for those frequencies at and near the resonant value was the resistance found to be of importance. For frequencies removed from the resonant value the resistance was seen in all cases to be negligible compared with the reactance, and so the variation of resistance did not manifest itself to any noticeable extent.

But when the circuit is tuned to different frequencies over a considerable range by adjusting the tuning capacity, the resistance will be the most important factor throughout the range of frequencies covered.

Both the voltage magnification at the resonant frequency and the selectivity of the circuit are inversely proportional to the decrement $\pi R\sqrt{\frac{C}{L}}$ of the circuit.

The voltage magnification is $m = \frac{1}{R}\sqrt{\frac{L}{C}}$ for a series

type of circuit, and the selectivity, defined on a 10 per cent. basis, as on page 22 of January 1st, 1930, issue of *The Wireless World*, is one-fifth of m , i.e., the selectivity is $\frac{1}{5R}\sqrt{\frac{L}{C}}$. Thus, as we have already seen,

for a fixed value of resistance the selectivity is improved by increasing the ratio of inductance to capacity. But in practice it is usually found that the selectivity of a tuned circuit is better at the upper end of the wavelength range, where the ratio of capacity to inductance is greatest, and worse at the lower end, where L/C is greatest, this being an apparent contradiction of the above statement. The facts, however, are not really

at variance with theory; it is the rapid increase of effective resistance with frequency that causes the falling off in selectivity at the lower end of the wavelength scale. The fact that the ratio of inductance to capacity is increased as the circuit is tuned to a lower wavelength partly offsets the deleterious effect of the increasing resistance—if the selectivity were independent of the ratio of inductance to capacity it would be even further reduced at the highest frequencies or lower wavelengths.

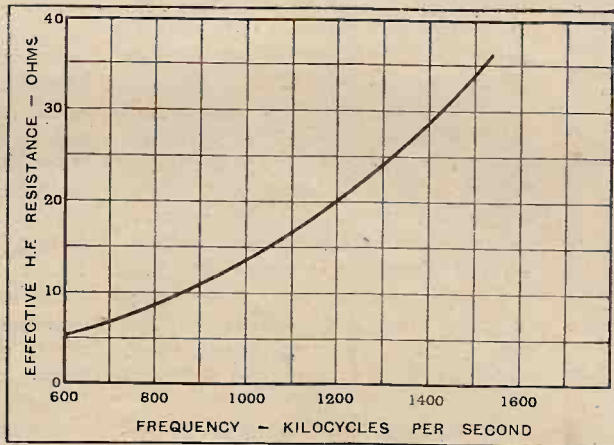

Fig. 1.—Curve showing H.F. resistance of a tuned circuit at various frequencies.

Details of an Actual Circuit.

This matter is a very important one, and, in order to show in the clearest way possible the manner in which the selectivity varies with the frequency to which the circuit is tuned, calculations are given for an actual tuned circuit and the results plotted in the form of curves. The coil itself was wound on a cylindrical former with Litz wire, the inductance being $211 \mu\text{H}$. The tuning condenser had a nominal maximum capacity value of 0.0003 mfd. , and connected directly across the circuit was an ordinary solid-dielectric valve-holder and valve.

The equivalent series high-frequency resistance was

Wireless Theory Simplified.—

measured with the circuit tuned to a number of different wavelengths ranging from 200 metres to 500 metres corresponding to a frequency range from 1,500 to 600 kilocycles per second. The values of the high-frequency resistance obtained are shown for various frequencies by the curve of Fig. 1.

It will be noted that at 1,500 kilocycles per second (200 metres) the high-frequency resistance is about six times as great as it is at 600 kilocycles per second (500 metres). The conductor resistance varies to a comparatively small degree as Litzendraht was used, and therefore this rapid increase of resistance with frequency is mainly due to the dielectric losses occurring in the circuit, particularly in the valve-holder and valve base. Figures of this order are quite common for tuned circuits in normal receivers, and when a particularly efficient tuning circuit is required, not only is a ribbed or skeleton former necessary for the coil, but, in order to eliminate the chief source of dielectric loss, the valve-holder and the base of the valve itself must be dispensed with. This was done in *The Wireless World Record III* receiver.

However, the present circuit with moderately high effective resistance at the lower wavelengths is chosen here because it conforms more closely to normal conditions, and serves to emphasise the effect of the resistance variation on the selectivity,

The values of H.F. resistance, the product LC, the quantity $\sqrt{\frac{L}{C}}$, and the selectivity number $\frac{1}{5R}\sqrt{\frac{L}{C}}$ for the circuit at different wavelengths and frequencies are given in the accompanying table. The value of LC in the fourth column is given in terms of microhenrys and microfarads.

The selectivity numbers are given by the full line curves of Fig. 2 and Fig. 3, plotted against frequency and wavelengths respectively, and these show clearly the falling off in selectivity at the higher frequencies and lower wavelengths in spite of the increased value of

Fre- quency.	Wave- length.	H.F. Resist- ance.	LC.	$\sqrt{\frac{L}{C}}$	Sele- ctivity Number.
kc.	m.	ohms.			
100	500	5.3	0.0704	795	30.0
800	375	8.7	0.0396	1,061	24.4
1,000	300	13.6	0.02533	1,326	19.5
1,200	250	20.0	0.01760	1,590	15.9
1,400	214	28.7	0.0129	1,856	13.0
1,500	200	34.0	0.01126	1,990	11.7

$\frac{L}{C}$. The broken-line curves in Figs. 2 and 3 are drawn to show how the selectivity would vary if the H.F. resistance remained constant at 10 ohms for all frequencies and wavelengths through which the circuit is tuned. These curves show that, but for the increase

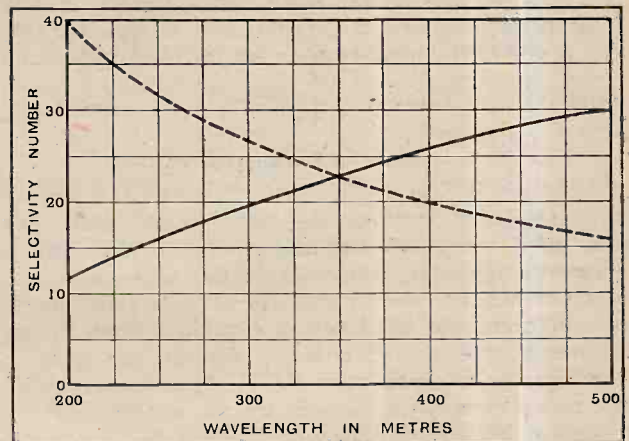

Fig. 3.—Variation of selectivity with wavelength to which the circuit is tuned. The conditions are the same as for Fig. 2.

of resistance which occurs, the selectivity would be greatest at the lower wavelengths where the ratio $\frac{L}{C}$ is greatest. For fixed inductance and variable tuning capacity the selectivity is directly proportional to the frequency if the resistance is constant.

Using a litz-wound extra low-loss coil in conjunction with a high-grade tuning condenser, and with most of the sources of incidental loss removed, it is sometimes found in practice that the selectivity actually improves as the circuit is tuned to lower wavelengths.

Parallel Type of Circuit.

The conditions which make for good selectivity in the series type of tuned circuit are identically the same for the parallel circuit, namely, that for fixed high-frequency resistance in the closed circuit, the selectivity is proportional to $\sqrt{\frac{L}{C}}$, so that the higher the ratio of inductance to capacity the better, other things being constant. But, as in the case of the series circuit, where the energising voltage is induced into the tuning coil, the selectivity falls off at the lower wavelengths due to the rising H.F. resistance when the circuit is tuned by a variable condenser.

In view of the fact that in practice one is advised to

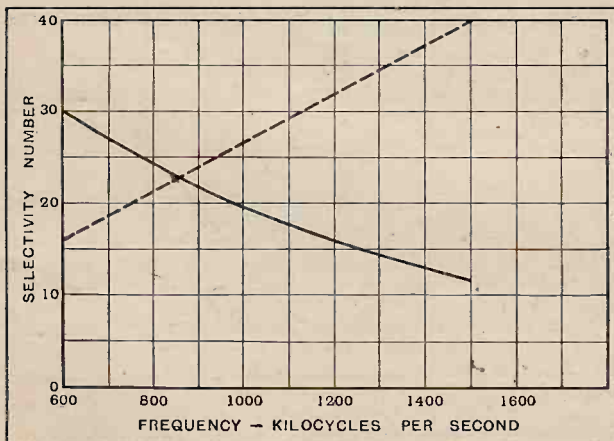

Fig. 2.—Variation of selectivity with frequency to which the circuit is tuned. The full line curve gives the actual selectivity taking into account the variation of H.F. resistance. The broken-line curve represents the imaginary selectivity obtained by assuming the circuit resistance to remain constant at 10 ohms.

Wireless Theory Simplified.—

design rejector circuits or wave-traps with a moderately low ratio of inductance to capacity, it must not be supposed that this is done because the selectivity is directly improved by having a low value of $\frac{L}{C}$; it may be indirectly improved because it is easier to construct a really low-loss circuit with a low ratio of inductance to capacity. For instance, in tuning to a given wavelength, if we decide to double the inductance and halve the capacity, the value of $\sqrt{\frac{L}{C}}$ is just doubled, but more likely than not the resistance will be more than twice as great in the second case, with a consequent actual decrease of selectivity. But, apart from this, it is necessary that the wave-trap should have as little effect as possible on the main tuning circuit at other frequencies than that of the station to be rejected, and this is one of the main reasons for the choice of a comparatively low value of $\frac{L}{C}$.

Selectivity of Parallel Circuit.

Although it was explained in Part XVII (January 15th issue) that for a parallel-tuned circuit the impedance is a maximum and the current a minimum at resonance in contradistinction to the series circuit, it was not actually shown that, in spite of this reversal of conditions, the selectivity of a parallel circuit is enhanced by the use of a large ratio of inductance to capacity for a given value of H.F. resistance within the closed circuit, just as it is for a series circuit.

This point is best explained by considering two circuits, such as the one shown in Fig. 4, each tuned to the same frequency and possessing the same coil resistance, but having different values of $\frac{L}{C}$. Accordingly,

let us suppose that one of the circuits, which we shall call A, has a coil inductance of 200 μ H. and a condenser capacity of 200 $\mu\mu$ F., and that the other, B, has a coil inductance of $L = 100 \mu$ H, and capacity $C = 400 \mu\mu$ F. The product LC is the same for each, so that both are tuned to the same wavelength, but for A

the value of $\frac{L}{C}$ is 10^6 , and for B it is 0.25×10^6 . Suppose each circuit to have a coil resistance of 20 ohms at the resonant frequency, which works

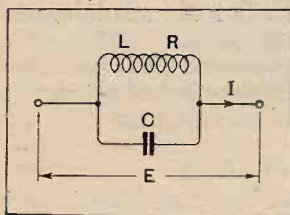

Fig. 4.—Parallel tuned circuit. At resonance $I = E \times \frac{CR}{L}$.

out to 796 kilocycles per second.

The current I_0 at the resonant frequency is given by $E \times \frac{CR}{L}$ amps, where $\frac{L}{CR}$ is the dynamic resistance.

Assume the applied voltage to be $E = 10$ volts. Then for circuit A the (minimum) current is $I_0 = 200$ microamps, and for B the current at resonance is $I_0 = 800$ microamps.

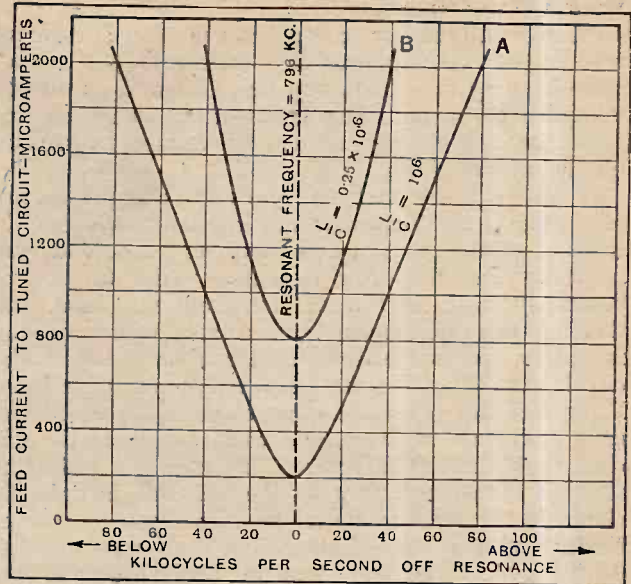

Fig. 5.—Resonance curves showing current in lead to parallel tuned circuit for various frequencies above and below the resonant value. Curve A is for a circuit in which $L = 200$ microhenrys, $C = 200$ micromicrofarads and $R = 20$ ohms. Curve B is for a circuit in which $L = 100$ microhenrys, $C = 400$ micromicrofarads and $R = 20$ ohms. The resonant frequency is the same for each circuit.

Now for frequencies removed from the resonant value by 40 kilocycles per second or more, the effects of the resistance are negligible, and the current is therefore given very approximately by

$$I = \frac{E}{2\pi fL} - 2\pi fCE \text{ amps.}$$

The currents have been calculated for both circuits A and B for various frequencies above and below the resonant value, and the results are given by the two

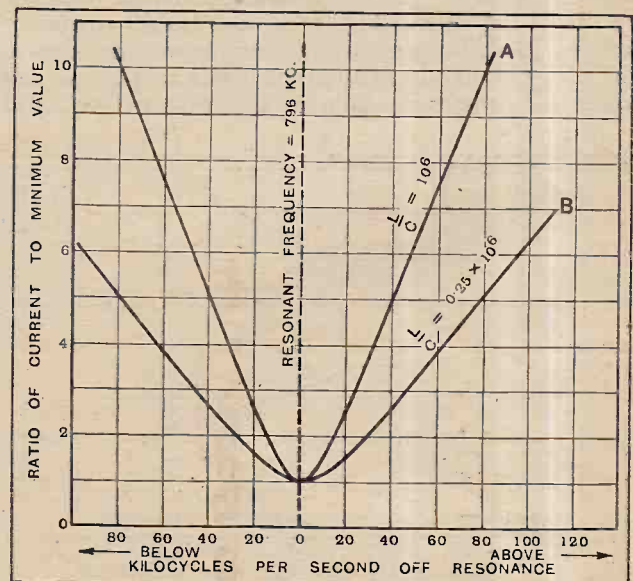

Fig. 6.—The curves give the current at various frequencies above and below resonance as a ratio of the minimum value at resonance for the same two circuits to which Fig. 5 refers. Curve A, for which $\frac{L}{C}$ is the greater, exhibits the better selectivity. The curves of Fig. 5 are misleading in this respect.

Wireless Theory Simplified.—

corresponding resonance curves A and B of Fig. 5. By inspection of these curves, one may easily be led to the false conclusion that, since the sides of curve B are steeper than those of A, the circuit B with the lower value of $\frac{L}{C}$ must have better selectivity than A. This is not the case. The selectivity is determined by the ratio of the current at a given frequency off resonance to the value of the minimum current at resonance. The shape of the resonance curve is not sufficient to indicate the selectivity—the height of the lowest point above the base-line plays an equally important part in this respect.

Explaining the Selectivity Number.

Before we can compare the two circuits as regards selectivity, the resonance curves must be redrawn so that their lowest points are the same distance above the horizontal axis of the graph. This has been done in Fig. 6, where the currents at the various frequencies are shown as ratios of the minimum values for the respective circuits. From these two curves it can be seen at a glance that circuit A has the better selectivity. For instance, at 40 kilocycles per second off resonance, it is clear that the current taken by circuit A is five times the resonant value, whereas for circuit B it is only just over two and a half times as great as its own resonant value.

As in the case of the series circuit, the selectivity number for the parallel circuit is given by $\frac{I}{5R} \sqrt{\frac{L}{C}}$, and for the benefit of the more technical readers the proof of this is given in the appendix.

(To be continued.)

APPENDIX.

Selectivity of Parallel-tuned Circuit.

At resonance the impedance (dynamic resistance) of the circuit is

$$Z_0 = \frac{L}{CR} \text{ ohms} \dots\dots\dots (1)$$

the frequency being $f_0 = \frac{\omega_0}{2\pi}$ cycles per sec. where $\omega_0 = \frac{1}{\sqrt{LC}}$.

At any other frequency $\frac{\omega}{2\pi}$ the resistance is negligible and the current is given by

$$\begin{aligned} I &= \frac{E}{\omega L} - \omega CE \text{ amps. (approximately)} \\ &= \frac{EC}{\omega} \left(\frac{1}{LC} - \omega^2 \right) \\ &= \frac{EC}{\omega} (\omega_0^2 - \omega^2) \\ &= \frac{EC}{\omega} (\omega_0 + \omega) (\omega_0 - \omega). \end{aligned}$$

If ω is only slightly different from ω_0 we may write $\omega_0 + \omega = 2\omega_0$.

Then $I = 2EC (\omega_0 - \omega)$ amps., and the impedance is therefore

$$Z = \frac{E}{I} = \frac{1}{2C (\omega_0 - \omega)} \text{ ohms} \dots\dots\dots (2)$$

Thus from (1) and (2) $\frac{Z}{Z_0} = \frac{2L}{R} (\omega_0 - \omega) \dots\dots\dots (3)$

Now defining the selectivity as the ratio of the resonant frequency to the change in frequency necessary to reduce the impedance to 10 per cent. of the resonant value, we have $\frac{Z_0}{Z} = 10$.

\therefore from equation (3) $\omega_0 - \omega = \frac{5R}{L}$,

and the selectivity number is

$$\frac{\omega_0}{\omega_0 - \omega} = \frac{\frac{1}{\sqrt{LC}}}{\frac{5R}{L}} = \frac{1}{5R} \sqrt{\frac{L}{C}}$$

which is the same as for the series circuit.

CORRESPONDENCE

The Editor does not hold himself responsible for the opinions of his correspondents.

Correspondence should be addressed to the Editor, "The Wireless World," Dorset House, Tudor Street, E.C.4, and must be accompanied by the writer's name and address.

DUPLICATE 5XX.

Sir,—I have just read your leader in *The Wireless World* of June 25th. I belong to that great majority of listeners who never write to the papers, whose needs and desires would appear to be quite unknown to the B.B.C.—Can they not be made to realise that Daventry 5XX is, and always must be, to a vast number of people, the only British station that can be seriously listened to?

I have never had the good fortune to hear a local station—Regional or otherwise—near enough to make it worth hearing. Here on the South Coast, the London Regional is quite impossible after dark, owing to fading and violent distortion.

Wherever I go, mostly in the south and west, I hear the same tale: "We only listen to Daventry; no other station is any good." It does not seem to me that the number of listeners is less in these areas, remote from the crystal reception areas so dear to the heart of the B.B.C., and we certainly get fine results in spite of long land lines.

Now if 5XX is to be done away with, the matter becomes urgent. Are we who do not live in London or Manchester to

be sacrificed? Are we to have to abandon wireless or, on the other hand, depend entirely on the long-wave Continental stations? Most of us would do the latter, for they are vastly better received than any medium-band transmission can ever be, unless one lives within about forty miles of the transmitter.

Your suggestion of a twin-wave Daventry would entirely meet the case. It could be received almost anywhere in England and Wales, with fairly simple sets, such as are already in use everywhere outside the few large towns, and it could provide two programmes. Daventry 5XX *must not go!*

I hope there will be a general outcry, but unfortunately the majority of licence-holders do not read the wireless Press, and do not know that they are threatened.

Hastings.

WM. A. LUCAS.

Sir,—All listeners who are not actually located within the service area of one of the shorter wave regional stations will be grateful to you for having drawn attention to the importance of 5XX, the long wave station. Over very large areas of the country, especially in some of the less thickly populated

districts, 5XX is the only B.B.C. station that can be received with any degree of certainty. It does not seem that 5XX will become any less important to these listeners even when the Regional Scheme is completed, and if alternative programmes are considered to be essential as part of the B.B.C. service, then surely the scheme is incomplete until we get a duplication of 5XX so as to provide an alternative on the long waves also.

Let us hope that such a practical and constructive suggestion will receive from the B.B.C. the attention which it deserves.

"SOUTH COAST."

AMATEUR TRANSMISSION ON 3.5 METRES.

Sir,—It may be of interest to those of your readers who are amateur transmitters to learn that G-2.N.I. and G-6.T.P. have been successful in working both C.W. and telephony on the above wavelength. Authority to transmit on 3.5 metres was granted on June 2nd of this year, and the transmission on the above wavelength took place on June 29th, 1930, over a distance of 15 miles, between the hours of 11 a.m. and 5 p.m. The wave was steady throughout, and no difficulty was experienced in making contact.

Notes of the reception were made, and all the items were verified later.

After transmitting on 5 metres for the past 18 months (up to a distance of 50 miles), a circuit has been evolved which gives promise of satisfactory working, even on considerably lower wavelengths than 3.5 metres.

G-2.N.I.
G-6.T.P.

RADIO SERVICING.

Sir,—I should like to reply to Mr. Shearman Dyer's letter on "Radio Servicing" in your issue of June 4th.

Mr. Dyer fails to show that the situation is any more complex than stated in your Editorial, and his defence of the average wireless dealer is weak, since such a man should have at least sufficient knowledge to diagnose all the commoner faults in a wireless set. Otherwise he is a common danger, and this is unfortunately true of the majority of wireless retailers. The facts are undisputable. I have only found one dealer in all my experience who had a sound knowledge of the subject, and would go to the trouble of obtaining special components.

No one would go to an unqualified doctor, and yet the whole public is compelled to deal with unqualified wireless men. There seems to be a general demand at the present day that men following occupations bringing them into contact with the property and persons of the public should be qualified. This move is good, and it is to be hoped that it succeeds; with respect to wireless, Mr. Dyer could be instrumental in bringing it about. In his last sentence he instructs us to "Pay the proper price, get the proper goods, and be certain of the fact that your dealer will be able to give you the proper service." This is just what we want to do, but it is a sad fact that the second two statements do not follow from the first one, and are, in general, untrue. The best way in which Mr. Dyer can ensure the truth of his own statements is to propose that no one shall enter the Wireless Retailers' Association without having passed some qualified examination in wireless. Then if the public goes to these dealers it will be certain of good service; at the same time the standing of the Association would be raised, and the result beneficial to all.

R. V. JONES.

Oxford.

Sir,—It is interesting to read your remarks regarding the need for skilled men to assist the public to satisfactory reception of broadcasting.

Every individual, in my opinion, desires to listen in, preferably on a loud-speaker. The vast majority of people know nothing of electricity, do not wish to learn, or buy no wireless magazines (it is this section of the public I refer to here). They buy a set according to the price they can afford, and their first bitter experience is usually the paying of as much or more for batteries, valves, or other accessories to make it go, followed by an upkeep cost; and it is only by luck if a degree of satisfaction and over-all efficiency is then obtained for the money spent.

Strictly speaking, there is a best wireless outfit for every particular home; and to arrive anywhere near this best set a skilled man has quite a few problems to solve in most cases. Excluding cost, other factors may make a small cheap set possible where a large, expensive set is impossible. Factors which will affect performance, such as local position, local interferences, aerial possibilities, etc., are more or less fixed; and with these factors in view, to meet the requirements, convenience, capabilities and expenditure of the listener take some thinking out. The important factor here is the capability of the listener to use and appreciate the performance of a set, and look after it where necessary. How hopeless it is, then, for a person who does not know what to buy or what he wants to select a wireless outfit and install it, when a skilled man has to weigh many factors one against the other.

The B.B.C. has concentrated its attention on the development of its stations and studios. The manufacturers' developments concentrate on a radio exhibition where amateurs and wireless dealers are the main critics, and all this fine industry is being built up on a foundation of props, formed by those amateurs who are willing to help the people around them. The heavy expenditure of money on waste material casts many shadows of reproach and no-confidence in the new industry. Public confidence is sinking rather low.

To restore confidence and build in a sound foundation to the industry, it would require the appointment of a highly skilled man in each district, who thoroughly knew the district and could appreciate the public temperament.

For the past three years I have been acting in such a capacity on my own account; fitting the public according to their capabilities and wishes with suitable receivers, and cutting down waste as far as possible. My main gain has been a wide experience, and my statements here are an interpretation of the position of the public as I find it in a long list of applicants of nearly every variety. My opinion is that, if public confidence were fully restored, it would mean a vast increase in new listeners, more valve-set users, and a scrapping of obsolete sets.

A. DUNNETT.

Aberdeen.

EMPIRE BROADCASTING.

Sir,—I see in your issue of June 25th that Mr. George L. Boag, of Aguilas, Spain, makes the amazing suggestion that licence payers in Great Britain should also contribute to the funds of foreign stations they may "reach out" to, and he instances P.C.J., Zeesen, etc. I may be rather dense, but may I ask him to be good enough to explain just why "elementary justice and reciprocity demand" this? If such were the case, it seems to me that the same reasons would also demand that all foreigners listening in to our British stations should likewise be called on to contribute to their upkeep. This country operates its broadcast system primarily for the benefit of its own nationals, who therefore, if they choose to take advantage of it, should rightfully be called on to provide the funds necessary for its maintenance. That listeners in other countries are also able to receive the programmes radiated, does not in practice affect the position, as this privilege is common to and enjoyed by listeners in all countries who are able to receive foreign transmissions.

R. F. McINNES.

Hounslow.

LATE PROGRAMMES IN THE NORTH.

Sir,—I notice in the May 28th issue of *The Wireless World* ("Broadcast Brevities") a reference to a supposed grievance of the Northern listeners, inasmuch as the broadcast stations close down at 11 o'clock.

I think you will find quite a different opinion actually exists. What the North wants is the good stuff earlier. All too often the best part of the programme is timed to commence at 9.40—too late an hour, as it must be remembered that northerners retire earlier than those in the south, though the powers controlling the broadcast do not take this into consideration. In my own neighbourhood, except in special circumstances, few people will be about after 10.30 p.m.

F. NEWTON.

Piccadilly, Manchester.



By Our Special Correspondent.

Colonial Office and Empire Broadcasting.—The "Proms."—A Sunday Plot.

Empire Broadcasting Again.

While all who have at heart the interests of Empire broadcasting will rejoice that the subject has at last received official discussion, they will temper their joy with the reflection that the money question has hardly been broached.

o o o o

Sir John Reith's Statement.

It is good, however, to hear Sir John Reith informing the delegates at the Colonial Conference that an efficient service would be possible if a high-power short-wave station could be established. Sir John reveals for the first time that the B.B.C. is really enthusiastic about the Empire broadcasting project.

o o o o

A Special Committee.

Very wisely the Conference has decided that the whole question deserves a special committee to discuss it. Problems arise on all sides. In addition to the financial question, the committee must consider whether transmissions would be required throughout the twenty-four hours; whether news only would be required, or whether it would be expedient to transmit general entertainment.

o o o o

Should the Treasury Pay?

I have heard it suggested that the expense of the service might well be defrayed out of the amount mulcted by the Treasury from the licence receipts. Last year this reached the figure of £342,000. The British listener might be unwilling to pay direct for an Empire service, but he could hardly object to the use of that portion of his money which is already diverted from the B.B.C.

o o o o

The "Proms."

Programme preparations are already well in hand for the thirty-sixth season of Promenade Concerts at the Queen's Hall, opening on Saturday, August 9th. The majority of the concerts will, of course, be broadcast. All of them will be conducted by the indefatigable Sir Henry Wood.

o o o o

Following Tradition.

The programmes will follow the traditional lines. We shall have Wagner on Mondays, Bach on Wednesdays, and Beethoven on Fridays. On Tuesdays miscellaneous programmes will be performed,

with a preponderance of Handel, Mozart, and other classical composers. Thursdays will be dedicated to British composers; Saturdays will be "Popular Nights."

o o o o

First Appearance of New Orchestra.

The players at the Queen's Hall will form part of the new B.B.C. Symphony Orchestra, which is ultimately replacing the local station orchestras. This will be its first public appearance.

o o o o

Hey Nonny Nonet.

Poor Birmingham, after putting up such a fight for the retention of her studio orchestra, will find her only outlet for musical expression in a "Midland Regional Studio Nonet."

A Nonet is a queer combination of nine players, for which very few, if any, works have been specially composed, and one is left with the impression that it will have to take refuge in "arrangements" of pieces for full orchestra. As one man quaintly described it, a nonet is "one over the eight."

FUTURE FEATURES.

- National (261 and 1,554 metres).
- JULY 14TH.—Songs of the French Revolution.
- JULY 15TH.—Eye-witness Account of the Test Match at Leeds.
- JULY 16TH.—"Antony and Cleopatra," by William Shakespeare.
- JULY 17TH.—"Midsummer Madness," feature programme.
- JULY 18TH.—Running Commentary on the Shooting for the King's Prize, Bisley.
- London Regional.
- JULY 16TH.—Concert of British Music, relayed from Frankfurt.
- JULY 17TH.—"Antony and Cleopatra," by William Shakespeare.
- JULY 19TH.—"Cuttings from the Potting Shed," feature programme.
- Midland Regional.
- JULY 14TH.—Rt. Hon. Stanley Baldwin: "Democracy—Old and New," relayed from Warwick Road Congregational Church, Coventry.
- JULY 16TH.—Commentary on the Pageant of Warwickshire, relayed from the grounds of Warwick Castle.
- North Regional (Manchester).
- JULY 15TH.—"An Evening at Blackpool."
- Glasgow.
- JULY 15TH.—A Scottish Concert.
- Belfast.
- JULY 18TH.—Running Commentary on Second Irish International Grand Prix Motor Race at Phoenix Park, Dublin.

Keep Calm.

Sympathisers with Sir Thomas Beecham can spare their tears if these arise from the report that the B.B.C. has sent Sir Thomas a bill for £5,000, representing his share in losses incurred over last season's symphony concerts in the Queen's Hall which were so badly attended that members of the orchestra became thoroughly depressed, despite their unseen audience.

o o o o

A Mere Joke.

The conductor is under no legal obligation. I believe that when the series started a few verbal pleasantries over coffee cups may have given rise to a half-jocular remark that the losses, if any, would be shared; but thoughts of a loss were not seriously entertained. Moreover, I am given to understand that the wealthy B.B.C. would on no account take advantage of an individual in the manner suggested.

o o o o

"Yes, and Back Again."

The above is a strangely appropriate title for the play which the B.B.C. were to have broadcast, and did not, on Sunday, June 29th. The very idea of broadcast drama on the Sabbath caused a rubbing of eyes when the draft programmes were scanned, but the item was down on the list, and *Wireless World* readers were at once informed.

o o o o

The Plot That Failed.

And what are the facts? The more daring of the drama enthusiasts at Savoy Hill considered that Walter de la Mare's play might escape the Sunday censor and, if so, open the way for regular dramatic broadcasts on the Sabbath. Their efforts nearly succeeded; I understand that the item was not vetoed until it came under the eye of very high authority, who at once considered it out of keeping with the day. Yes, and back again . . . to the ordinary humdrum Sunday programme.

o o o o

A Happy Augury.

Joy abounds at Indian broadcasting headquarters, I understand, in consequence of a rumour that radio sets were stolen during a recent raid in connection with the Salt Law disturbances.

The theft is held to be a gratifying indication that Indian broadcasting programmes are at last being appreciated.

READERS' PROBLEMS.

"The Wireless World" Supplies a Free Service of Technical Information.

The Service is subject to the rules of the Department, which are printed below; these must be strictly enforced, in the interest of readers themselves. A selection of queries of general interest is dealt with below, in some cases at greater length than would be possible in a letter.

An "Ideal Home" Radio-Gramophone.

I am thinking of buying a gramophone pick-up for use in conjunction with my "Ideal Home" receiver. Will it be necessary to add another L.F. amplifying stage to the receiver? My requirements in the matter of volume are not particularly ambitious.

C. C. A.

Provided that you choose a fairly sensitive pick-up—and in this matter you may well be guided by the reviews of these devices which appeared in our issues of March 26th and April 2nd—the receiver should give quite good results as it stands. It would be advisable, in an attempt to get as much magnification as possible, to use a detector valve of fairly high magnification (say, a good specimen of the "20,000-ohm" class), and also to use an anode coupling resistance of about 250,000 ohms.

○○○○

Measuring "Free" Grid Bias.

I believe that I am right in saying that it is impossible accurately to measure the voltage produced by a "free" grid bias device merely by connecting an ordinary voltmeter between grid and cathode of the valve concerned. At any rate, this method, as applied to my own receiver, gives results that are obviously incorrect; is there any simple way of making a direct measurement?

G. K. R.

As you suggest, it is none too easy to make an exact measurement of grid bias obtained in this way. In any case, the reading indicated by the ordinary type of voltmeter would often be much

closer to the truth if the instrument were directly connected across the bias resistance, and not between grid and cathode. By doing this, the resistance of whatever component is included in the grid circuit is in series with the meter, and may easily be quite high enough to produce an altogether excessive voltage drop.

It is probably best to work by an "indirect" method rather than to attempt to take direct readings. If one knows the value of the resistance across which bias potentials are developed, it is easy, after having measured the current flowing through the anode circuit of the valve concerned, to calculate the voltage drop. To do this, it is merely necessary to multiply the value of the resistance (in ohms) by the current passing (expressed as a fraction of an ampere).

○○○○

Indirectly Heated Pentode.

I was interested in your recent review of an indirectly heated pentode (the AC/PEN). Do you consider that it is worth while replacing a directly heated pentode of very similar characteristics by this new valve in a three-valve A.C. mains receiver?

L. D. S.

By using an indirectly heated valve it becomes much easier entirely to eliminate all traces of hum; this is one of the outstanding advantages of this form of construction. Accordingly, if you are not completely satisfied with the background silence of your receiver, you might well try the use of one of these new valves.

○○○○

A Choked Grid Circuit.

Since fitting a grid bias eliminator to my receiver I have noticed that the effects of occasional overloads are much more pronounced than previously, both aurally and when judging by the indications of a milliammeter connected in series with the output valve anode. Except for this one detail, the behaviour of the set seems to be exactly as before.

Can you recommend any alterations to my bias eliminator, of which I am enclosing a circuit diagram?

O. M. D.

Your diagram (not reproduced) shows an entirely conventional type of eliminator, and there should be no need to introduce any modifications. We observe, however, that the grid circuits are decoupled: this is all to the good, but it must be remembered that an occasional overload, such as that due to an atmo-

spheric, may well bring about the accumulation of a charge in the by-pass condensers, which are always of large capacity. You do not show values for the decoupling resistances and condensers, but it is quite likely that the resistances of the former are so high that a charge cannot rapidly leak away, with the result that the effects of overloading are made very evident, because one or more grids may be temporarily paralysed.

We advise you to try an experimental reduction in the values of either condensers or resistances—preferably the latter.

○○○○

Power Transformer Construction.

I have made up the power transformer described in your issue of February 19th, but am troubled by the fact that it heats up seriously after running for a few minutes. The rise in temperature is considerable, and I am sure is much more than would be tolerated in a good design. Can you suggest a likely cause of the trouble?

F. M.

This 25-cycle transformer was designed on a liberal basis, and there should be no appreciable temperature rise. If the specification has been followed faithfully, we can only assume that the heating is due to short-circuited turns, or even to a short-circuited section. It is impossible to say in which winding this short-circuit is likely to be found, as a fault in either primary or secondary would have a similar effect.

○○○○

Sharpness of Tuning.

My recently constructed "2-H.F." set, with two-circuit aerial tuner and anode bend detector, is giving extremely satisfactory results; but I am rather puzzled by the fact that the sharpness of tuning of the four circuits is not quite as I should expect. Starting from the input end, the aerial circuit is, as one would expect, quite flat, while the secondary and first intervalve circuits tune as sharply as need be. Contrary to my expectations, the secondary circuit of the last H.F. transformer is almost as flat in tuning as the aerial circuit. Does this imply that there is some leakage or a high-resistance connection in this part of the receiver?

J. K. G.

It seems probable that this may be due to the well-known "reversed reaction" effect of an anode bend detector, which has been discussed in several articles in *The Wireless World*. You can check this point by temporarily connecting a large condenser—larger than can be tolerated from the point of view of quality—between anode and filament of the detector. If tuning is appreciably sharpened by this alteration, it can be assumed that the constants of your rectifier circuit might well be altered.

It is just possible that a seeming flatness of tuning of the last intervalve coupling is due to detector overloading. If it is, the effect will disappear when the receiver is tuned to a weak transmission.

RULES.

(1.) A query must be accompanied by a COUPON removed from the advertisement pages of the CURRENT ISSUE.

(2.) Only one question (which must deal with a single specific point) can be answered. Letters must be concisely worded and headed "Information Department."

(3.) Queries must be written on one side of the paper and diagrams drawn on a separate sheet. A self-addressed stamped envelope must be enclosed for postal reply.

(4.) Designs or circuit diagrams for complete receivers or eliminators cannot ordinarily be given; under present-day conditions justice cannot be done to questions of this kind in the course of a letter.

(5.) Practical wiring plans cannot be supplied or considered.

(6.) Designs for components such as L.F. chokes, power transformers, complex coil assemblies, etc., cannot be supplied.

(7.) Queries arising from the construction or operation of receivers must be confined to constructional sets described in "The Wireless World"; to standard manufactured receivers; or to "Kit" sets that have been reviewed.

"TILTRACK"

Registered Trade Mark
Patent STEEL STORES System

CAN YOU FIND IT IN ONE?



what about YOUR Stores?

Holing out in one is a most difficult feat, as every golfer knows. Yet it is more difficult still, in some stores, to find things at the first attempt—or the twenty-first for that matter!

Why go on losing goods and wasting time with old-fashioned bins and pigeon-holes? Why not have the

goods in view in "Tiltracks" in compartments of the correct size for each component? With "Tiltracks" you can store goods in the least possible space and most convenient form for handling.

"TILTRACKS" ARE MADE IN MANY STYLES; For the Experimenter, The Factor, and The Manufacturer. Send to-day for Lists.

THE "BENCHRACK" (Tiltrack Principle).

A real help for storing small parts such as Terminals, Nuts, Washers, Insulators, etc. Made to stand on the work bench, it enables all small parts needed for the job in progress to be stored where they are immediately to hand. All the trays are tilted so that the parts stored can be seen at a glance, and the front faces of the trays are rounded so that the smallest parts can be swept up the slope with the fingers of one hand. Each tray is provided with patent hinging partitions which can be moved quickly to make larger or smaller compartments. Being so accessible these racks greatly facilitate stocktaking. The Experimenter will do his jobs much quicker and with greater pleasure, and the Factory will save many pounds per year by installing this Benchrack.

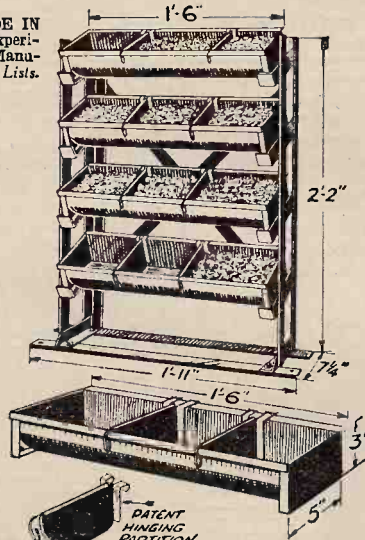

30/- F.O.R.

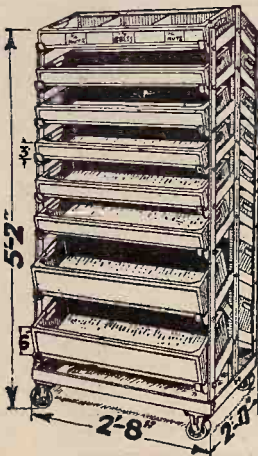

TILTRACK WHEELED TRUCK.

Can be wheeled right up to the job and in any direction. Invaluable for assembling or dismantling machines of all classes. Mounted on ball-bearing castors.

TILTRACK "TWEENIE."

A splendid rack for storing goods. Very compact, with great storage capacity, compartments subdivisible at will.

Price 70/- F.O.R. M/cr.



Particulars from Manufacturer & Patentee:—
BERTRAM THOMAS, Worsley Street, Hulme, MANCHESTER.
London Office and Showroom:—28, Victoria Street, S.W.1.

Announcing— NEW VARLEY 300 Henry L.F. CHOKE



for a modern radio need

Varley again lead the way with the first L.F. Choke on the market suitable for choke feeding L.F. Transformers following power grid detectors.

Varley 300 Henry L.F. Choke. 300 Henries with no Direct Current.

200 Henries when carrying 8 m/a, the normal anode current of a power detector.

Remains inductive up to 800 cycles.

D. C. Resistance 3,000 ohms.

Price 25/-

AVAILABLE NEXT WEEK.



Advertisement of Oliver Pell Control Ltd., Kingsway House, 103, Kingsway, London, W.C.2. Telephone: Holborn 5303.

MISCELLANEOUS ADVERTISEMENTS.

NOTICES.

THE CHARGE FOR ADVERTISEMENTS in these columns is:

12 words or less, 2/- and 2d. for every additional word.

Each paragraph is charged separately and name and address must be counted.

SERIES DISCOUNTS are allowed to Trade Advertisers as follows on orders for consecutive insertions, provided a contract is placed in advance, and in the absence of fresh instructions the entire "copy" is repeated from the previous issue: 13 consecutive insertions 5%; 26 consecutive, 10%; 52 consecutive, 15%.

ADVERTISEMENTS for these columns are accepted up to FIRST POST on THURSDAY MORNING (previous to date of issue) at the Head Offices of "The Wireless World," Dorset House, Tudor Street, London, E.C.4. or on WEDNESDAY MORNING at the Branch Offices, 19, Hertford Street, Coventry; Guildhall Buildings, Navigation Street, Birmingham; 280, Deansgate, Manchester; 101, St. Vincent Street, Glasgow, C.2.

Advertisements that arrive too late for a particular issue will automatically be inserted in the following issue unless accompanied by instructions to the contrary. All advertisements in this section must be strictly prepaid.

The proprietors retain the right to refuse or withdraw advertisements at their discretion.

Postal Orders and Cheques sent in payment for advertisements should be made payable to **ILIFFE & SONS Ltd.**, and crossed **& Co.** Notes being untraceable if lost in transit should not be sent as remittances.

All letters relating to advertisements should quote the number which is printed at the end of each advertisement, and the date of the issue in which it appeared.

The proprietors are not responsible for clerical or printers' errors, although every care is taken to avoid mistakes.

NUMBERED ADDRESSES.

For the convenience of private advertisers, letters may be addressed to numbers at "The Wireless World" Office. When this is desired, the sum of 6d. to defray the cost of registration and to cover postage on replies must be added to the advertisement charge, which must include the words Box 000, c/o "The Wireless World." Only the number will appear in the advertisement. All replies should be addressed No. 000, c/o "The Wireless World," Dorset House, Tudor Street, London, E.C.4. Readers who reply to Box No. advertisements are warned against sending remittance through the post except in registered envelopes; in all such cases the use of the Deposit System is recommended, and the envelope should be clearly marked "Deposit Department."

DEPOSIT SYSTEM.

Readers who hesitate to send money to unknown persons may deal in perfect safety by availing themselves of our Deposit System. If the money be deposited with "The Wireless World," both parties are advised of its receipt.

The time allowed for decision is three days, counting from receipt of goods, after which period, if buyer decides not to retain goods, they must be returned to sender. If a sale is effected, buyer instructs us to remit amount to seller, but if not, seller instructs us to return amount to depositor. Carriage is paid by the buyer, but in the event of no sale, and subject to there being no different arrangement between buyer and seller, each pays carriage one way. The seller takes the risk of loss or damage in transit, for which we take no responsibility. For all transactions up to £10, a deposit fee of 1/- is charged; on transactions over £10 and under £50, the fee is 2/6; over £50, 5/-. All deposit matters are dealt with at Dorset House, Tudor Street, London, E.C.4, and cheques and money orders should be made payable to Iliffe & Sons Limited.

SPECIAL NOTE.—Readers who reply to advertisements and receive no answer to their enquiries are requested to regard the silence as an indication that the goods advertised have already been disposed of. Advertisers often receive so many enquiries that it is quite impossible to reply to each one by post.

"WIRELESS WORLD"

INFORMATION COUPON

This Coupon must accompany any Question sent in before

JULY 16th, 1930

For Particulars of Free Service, see Rules on page 50.

WITHOUT FEAR—
Send your material for credit—where radio part exchange began. A service ruled only by economics, above bargaining or petty gain.

Particulars from the Secretary,
HONOR OMNIA APPLEBY'S,
Chapel St., Marylebone, London

SUPER

THE DIX-ONEMETER

It has Two Clear Scales with Mirror for Accurate Reading; only 6 Terminals, but 50 Ranges.

NOW ONLY **50/-** A remarkably low price for a meter worth **£10**

For Novice or Expert. Test Booklet Free.

BIG BARGAIN LIST OF LABORATORY APPARATUS AND RECEIVERS ON APPLICATION

ELECTRADIX RADIOS

218, Upper Thames St., London, E.C.4. Tele: City 0191

BONA FIDE TRADERS' GUIDE.

Send for our comprehensive Illustrated List, QUICK SERVICE. QUICK SERVICE.

THE QUALITY HOUSE.

PERSEUS MFG. CO., LTD. (Dept. W.W.)
BRANSTONE RD., BURTON-ON-TRENT.

A 2½d. Stamp

brings you Post Free a **POLAR TUNING GRAPH** which enables you to record and identify any station by its wavelength.

Dept. "W."

WINGROVE & ROGERS Ltd.
188-9, Strand, London, W.C.2.



ELEX

T.14 PLUGS & SOCKETS.
Standard Socket 1d. each. Plug 3d. each. 6 colours. Name Plates, 40 kinds, 1d. each. Write for list X103.

J. J. EASTICK & SONS, 118, Bunhill Row, London, E.C.1.

Plug in parts.

ALL MAINS TRANSPORTABLE

Retail Price 20 Guineas.

Applications are invited for District Agencies.

YATES, SUTTON, Ltd., York St., LEICESTER.

BOOKS on WIRELESS

Write for complete list to
ILIFFE & SONS LTD.,
Dorset House, Tudor St., London, E.C.4.

W.W.1.

RECEIVERS FOR SALE.

SCOTT SESSIONS and Co., Great Britain's Radio Doctors.—Read advertisement under Miscellaneous. [0264]

HIRE a McMichael Portable Set, by day or week, from Alexander Black, Wireless Doctor and Consultant, 55, Ebury St. S.W.1. Sloane 1655. [0328]

5-VALVE Set, new Mullard valves, U.K. bases, A.C. and D.C. eliminators, speaker; lot £10, or would separate.—Hay-Shaw, 4, Queensberry Place, London, S.W.7. [1916]

PORTABLE Five, leather suitcase, 16 guinea model, Continentals guaranteed; £5/10 complete.—2, Dollis Hill Av., Cricklewood, N.W.2. [9913]

PORTABLE Marconiphone, type 55, as new; a bargain, sacrifice £10.—2, Midway Rd., Romford, Essex. [1911]

BARGAIN—5-valve screen grid portable, light, selective, excellent condition; cost 30 guineas, offered at 10 guineas.—Box 6680, c/o The Wireless World. [1909]

KILO-MAG Four, complete, Bercliff cabinet, Wearite coils, Mazda valves, added Ferranti pull-push, together with Exide A.C. triode charger (H.T. and L.T.), 150v. H.T., 5,000 m.a. and 2v. 80 I.T. accumulators; lot £16; also Western Electric cone speaker, £1/10.—Newton, Higheroft, Stanneylands Rd., Wilmslow, Cheshire. [1905]

BERCLIFF D.C.2 All Mains Receiver, 200 to 250 volts D.C.; price £14/10; with valves and royalties, suitable for M.C. speaker; particulars free; trade inquiries specially invited.—Simmonds Bros., Shireland Rd., Smethwick. [8734]

YOUR Old Receiver or Components Taken in Part Exchange for New; write to us before purchasing elsewhere, and obtain expert advice from wireless engineer of 25 years' professional wireless experience; send a list of components or the components themselves, and we will quote you by return post; thousands of satisfied clients.—Scientific Development Co., 57, Guildhall St., Preston. [0225]

PUBLIC Address Amplifier, 7 valves, suitable skating rink, dance hall, cafe, 2 Star moving coil speakers, cost £70, accept £20; Marconi 5-valve public hall amplifier, £4; 2 Brown Q bases for outdoor use, new, 15/- each.—Box 6700, c/o The Wireless World. [1943]

MUSIC Magnet and S.G. Valve, £3/10; 3-valve set, complete, less speaker, 4/15; 200-230v. L.T. and H.T. charger, £2; the lot £9/10.—51, Middleton Park Sq., Leeds. [1933]

7-VALVE Symphony A.J.S. Superheterodyne, complete with valves and long and short frame aerials, perfectly new and unused; £14/10 bargain.—Smith and Co., 8, Houghton St., Southport. [1928]

ACCUMULATOR HIRE.

DON'T Buy Accumulators or Dry Batteries, join our C.A.V. low- and high-tension accumulator hire service, the largest and best in London; better and cheaper reception with no trouble; regular deliveries within 12 miles of Charing Cross; no deposit, payment on each delivery or by quarterly subscription; over 10,000 satisfied users; explanatory folder post free; phone or write to-day.—Radio Service (London), Ltd., 105, Torriano Av., N.W.5. Phone: North 0623-4-5. [18751]

CHARGERS AND ELIMINATORS.

PHILIPSON'S Safety High Tension Supply Units for A.C. and D.C. Mains, 200-250 volts 40-60 cycles, also 230 volts 25 cycles.

10/- Down and Small Monthly Payments Secures the Finest H.T. Supply Available.

PHILIPSON'S Safety H.T. Units are Guaranteed for 12 Months Against All Defects.

ALL Models Sold on 7 Days' Approval to Ensure Complete Satisfaction.

PHILIPSON'S Safety H.T. Units are the Cheapest to Install and the Cheapest to Run; £1/17/6 to £6.

WRITE for Our Booklet "Radio Power," which gives illustrations and full particulars.

PHILIPSON'S Safety Loud Speaker Output Filters for All Receivers, power valve, or Pentode; a remarkable output filter at a very low price; 16/6.

PHILIPSON and Co., Ltd., Radio Engineers, Astley Bridge, Bolton. Phone: 2038 Bolton. [0318]

ACVOKE L.T. Charger, rotary, operates on 220v. D.C., and provides 25v. 10 amps., complete with charging board, meters, etc.; cost over £30, will accept £10, or offer.—Norton, High St., Porlock, Somerset. [9783]

CHESTER BROS.—All types of mains transformers and chokes to any specification.—Chester Bros., 244, Dalston Lane, London, E.8. [9798]

A.S.

Mention of "The Wireless World," when writing to advertisers, will ensure prompt attention.

Chargers and Eliminators.—Contd.

REGENTONE 200 volt 100 m'amp., 200-230, 50 cycle eliminator, list £12, sell £4/10, or exchange good modern equipment; parts wanted, Band-Pass Four—Gerron, 3, Cowper St., Leeds. [9899]

MARCONI D.C.3 Unit, 20/-; Marconi D.C.2 unit, 30/-; Fellows 1/2 amp. charger, 25/-; Ekoo D.C. unit, 4 tappings, 15/-; Revophone crystal set, 10/-; 2-valve set, complete with coils and valves, 35/-—80, Wollington Rd., S.E.27. [9908]

ELIMINATOR D.C.240, used on 3v. sets; changed current causes sale; £1.—'Catisbrooke,' Acton Lane, N.W.10. [9895]

SAVAGE'S Specialise in Wireless Power from the Mains; reliable apparatus at reasonable prices.

SAVAGE'S—Transformer laminations and Bakelite hobbins; intending home constructors should write for list.

SAVAGE'S—Reliable smoothing condensers, 1,500 volt D.C. test, 1 mfd., 2/-; 2 mfd., 3/-; 4 mfd., 5/3; 500 volt D.C. test, 1 mfd., 1/6; 2 mfd., 2/3; 4 mfd., 3/9.

SAVAGE'S—Super smoothing and output chokes, many types available; write for list.

SAVAGE'S—Mains transformer for Westinghouse H.T.4 unit, with additional winding, 4 volts centre tapped 3 amps, 23/-; transformers for other Westinghouse units available.

SAVAGE'S—Mains equipment for new Foreign Listeners. Four, transformer N.F.L.4, 33/-; smoothing choke, C32G, 20/-; output choke C32O, 20/-.

SAVAGE'S—Mains equipment for Power Pentode Two transformer, P.P.2, 53/-; output choke, L.C. 36P.G., 19/6; smoothing choke, L.C.36G, 18/-.

SAVAGE'S—Mains transformer B.T.4, 500-0-500 volts, 120 m. amps., 7½ volts 5 amps., 6 volts 3 amps., 4 volts 2 amps., 4 volts 1 amp., 4 volts 1 amp., all centre tapped, specially developed for automatic bias; 57/6.

SAVAGE'S—Mains transformers and power chokes are carefully and individually constructed from first class materials, with an exceptionally generous margin of safety.

SAVAGE'S, 146, Bishopsgate, London, E.C.2. Phone: Bishopsgate 6998. [9165]

RADIELLE, model D.C.100 (200-250 D.C.), output 200 volts, 100 m.a., and 2 variable tappings; cost £9/10, sell £2/5; brand new; sent c.o.d.—Priestley, 74, Aberdeen Rd., Highbury, London, N.5. [9939]

RADIELLE 50-watt Power Amplifier, 2-stage I.S. 6As i- output; cost £20, sell £5; brand new, perfect; first cheque secures.—Priestley, 74, Aberdeen Rd., Highbury, London, N.5. [9940]

REGENTONE A.C. Unit, 200-250 volts, W.1B S.G., 1 variable 0-120 S.G., 1 variable 0-120, 1 fixed 130-150 volts, as new; £2/12/6.—G. Peppiatt, "The Limes," Highgate Rd., London, N.W.5. [9932]

WONDERFUL Value in Mains Transformers and Chokes, finest workmanship and guaranteed for one year, all transformers with universal inputs; outputs 135v. 20 m.a., for Westinghouse H.T.3 rectifier, 15/-; 4v. 5a., extremely good regulation, 19/6; chokes: 32H, 30 m.a., 7/6; 35H, 50 m.a., 15/-; 28H, 150 m.a., 30/-; special transformers wound to your own requirements; write us for quotations and lists.—Elison Manufacturing Co. Ltd., Dragon Works, Harrogate. [9927]

WELL-KNOWN H.T. Trickle Chargers, metal rectifiers, for sale, 200-240 volts, 40-120 cycles, with simple smoothing circuit, ideal eliminators, output on 200-volt mains 150 volts, 10 m.a. guaranteed; 37/6.—Chapman, 16, St. Dunstan's Rd., W.6. [9920]

PYE—Brand new guaranteed model 924 eliminator, 200-250 A.C., 20 m.a. output, 2 tappings; cost £5/5, sell £3/10.—Lallemand, 5, Charles St. (Hatton Garden), Holborn, London, E.C.1. [9944]

CABINETS.

CABINETS for All Requirements.—F. W. Ramsey, 63, Shaftesbury St., London, N.1. Clerkenwell 7139. [9736]

DIGBY'S Cabinets.—Table models in solid oak and mahogany; from 11/6 to 71/-.

DIGBY'S Cabinets, fitted with Radion or Resiston ebonite if required.

DIGBY'S Cabinets.—Pedestal model, with separate battery components; from 56/- to £12.

DIGBY'S Cabinets Made to Customers' Own Designs.

DIGBY'S Cabinets.—Write for new 16-page art catalogue.—F. Digby, 9, The Oval, Hackney Rd., E.2. Phone: Bishopsgate 6458. [0128]

COILS, TRANSFORMERS, ETC.

TRANSFORMERS and Chokes for Battery Eliminators.—Chester Bros., 244, Dalston Lane, London, E.8. [9706]

Why not dance to Radio Paris, Toulouse and Hilversum Music?

With the "Supremus" All Electric 2-Valve Receiver it is the simplest matter. So simple that even a child can operate it. You should hear it. Long and short wave stations can be obtained by the mere operation of a switch. This set is equal to any 3-valve **battery** operated receiver. London listeners have been specially catered for and stations can be parted easily. There is a 12 months' guarantee with each set.

PRICE £12:0:0.

Using a "Supremus" All Electric 2-Valve Receiver a Birmingham amateur picked up 18 stations full speaker strength at first attempt.

"SUPREMUS" 2-VALVE ALL ELECTRIC

SUPREMUS SPECIALITIES Ltd.,
118, HIGH ST., ERDINGTON, BIRMINGHAM
Northern Agents: THE CHORLTON METAL CO., 18, Amber Street, Manchester.
London Agent: P. H. SMEDLEY, 50, Richmond Road, Leytonstone, E.11.

THE PILOT LEADS!



THE VERY FINEST TRANSFORMERS AT COMPETITIVE PRICES.

GIVE PILOT TRANSFORMERS A TRIAL AND YOU WILL USE NO OTHERS.

CLEAR AND CRISP REPRODUCTION OF BOTH HIGH NOTES AND BASS.

NO RESONANCE.

In Three Ratios: 2-1, 3½-1, 5-1.

BAKELITE CASE .. 11/6
METAL CASE 9/6

Also all Components manufactured by the Pilot Radio and Tube Corporation of New York.

Write for Catalogues to:—

THOMAS A. ROWLEY LTD.,
59, SKINNER LANE, BIRMINGHAM

Sole Agents for Great Britain and Ireland.

Coils, Transformers, Etc.—Contd.

600 and 1,000 Ohms Decoupling Resistances, specified for the largest and most important "Wireless World" receivers; 1/6 each, post free.—Grovers Brothers, St. Mary's Place, Shrewsbury. [9864]

BAND-PASS Four, Coils, complete, 80/-; Ideal Home receiver coils, complete, 43/-; superhet. adaptor coils and base, 24/-; S.G. S.W. Three, 4 coils, 34/-; 4 additional, 46/-; Berclif coils from stock for all popular sets; trade supplied.—Simmonds Bros., Shireland Rd., Smethwick. [9941]

F.C. Wireless Set of 10 Coils for Band-Pass Four, as specified; £2/5.—28, Premier Place, High St., Putney, S.W.15. [9923a]

BAND-PASS Four Coils, set of 5, matched long wave coils to "W.W." specification, silk wound on turned ebonite former, 12/6 per set, post free; formers, 1/- each; special silk wound H.F. chokes, specially designed for S.G. circuits, 2/6 each; from makers.—Sound Sales, Tremlett Grove, Highgate. [9936]

DYNAMOS, ETC.

M-L Motor Generator Set, type E, for 240 volts D.C., output 100 m.a. at 400 volts high tension, 3 amps. at 6 volts low tension, with smoothing units both: high and low, and reverse current cut-out; £15.—Box 6650, c/o *The Wireless World*. [9900]

SALE! Sale! Sale!

M-L Converters, supplying 6 volts at 6 amps. and 400 volts at 200 m.a., complete with motors, switchboards, output chokes and T.C.C. condensers, all voltages, A.C. and D.C. input; £15 each.

11 New Crypto Size No. 242 Electric Generators, with starters, primary 220 volts 6 amp, 3,000 revs., secondary 240 volts 800 v.a.; £10 each.

FIVE New Crypto Size No. 227, primary 110 volts 8 amps at 3,000 revs., secondary 240 volts; £7 each.

ONE New Ditto, 80 volts; £7.

ONE New Ditto, 70 volts; £7.

ONE New Motor Driven Generator Crypto, fitted 240-volt motor, coupled to 110-volt generator, 13.2 amps, bedplate and starter; £17/10.

80 4-, 6- and 12-volt Amplifiers only, all fitted Ferranti transformers, suitable for cinema, public address and dance hall work; £4, £6 and £12 each.—Slough Radio Co., Ltd., Bath Rd., Slough. [9938]

GRAMOPHONES, PICK-UPS, ETC.

ELECTRIC Gramophone Motors, complete, £3; complete set of machined parts without motor (take your own motor), 25/-; new 10in. turntables 2/6, 12in. 3/6; quick-stop radio switches, 1/-; gramophone governors, 2/6; several odd boxes assorted radio gramophone parts, 5/-; electric gramophone gears, 5/- set; Radio text book, 880 pages of reading, designs, and circuits, 5/-; all post free.—Mott, "Applegarth," Claygate, Surrey. [9907]

IGRANIC Patent Phonomotor, 110 volts A.C. 60 cycles, in new condition, with turntable, 50/-; Phonovox pick-up, 10/-—No. 1, The Spur, Burnham, Bucks. [9918]

PICTURE RECEIVER APPARATUS.

TELEVISION—Scanning discs, Neon tubes, experimental models made.—John Salter, Member Television Society, Featherstone Buildings, Holborn, W.C. [9892]

VALVES.

AMPLIFIER Valve.—If you require power you cannot do better than one of these:—

FILAMENT Volts 6, plate volts 400 (maximum). Grid bias 84 volts (approx.), impedance 800 ohms, amplification factor 3.8 mutual conductance 4.35 m.a./volts; price £5/10; see article "The Wireless World," 24th July, 1929, then send to North London Valve Co. Ltd., 22½, Cazenove Rd., Stoke Newington, London, N.16. [9812]

NEW L.S. 6A, 15/-, slightly used; one P.M.1 H.F., one P.M. A. 4/- each; 25-1 transformer, 6/-—Newth, 31, George St., Hanover Sq., London, W.1. [9931]

LOUD-SPEAKERS.

BAKER'S SELHURST RADIO 36-page Booklet. "Sound Advice is Yours for the Asking"; write now for new edition; see displayed advertisement on page 9. [0231]

14 IN. Ultra Air Chrome Loud-Speaker, brand new, in beautiful mahogany finished; retail price of chassis alone 52/-, price for quick sale 37/6.—Elison, Brooklands, Follifoot, Harrogate. [9893]

Loud-Speakers.—Contd.

EPOCH Moving Coil Speakers are Masterpieces, designed and produced by master engineers.

EPOCH Moving Coil Speakers are the Standard by which other Speakers are Compared.

EPOCH Moving Coil Speakers are in Use in Many Editorial Offices.

EPOCH Moving Coil Speakers are in Use in Several Famous Laboratories.

EPOCH Moving Coil Speakers are in Use in Many Broadcasting Stations.

EPOCH Moving Coil Speakers are in Use by Most Prominent Musicians.

EPOCH Moving Coil Speakers Bring Unbounded Joy to Thousands upon Thousands of Homes.

EPOCH Moving Coil Speakers, the only speakers that give clear, uncoloured reproduction.

EPOCH Moving Coil Speakers do Render Speech Perfectly and Music Correctly.

EPOCH Moving Coil Speakers Provide the Perfect Illusion of the Artist's Presence.

EPOCH Moving Coil Speakers Represent the Finest Intrinsic Value Ever Offered.

EPOCH Moving Coil Speakers are Guaranteed for a Year, but last for ever.

EPOCH Moving Coil Speakers Bring the Grand Concert out of the Most Modest Set.

EPOCH—You can hear a hundred moving coil speakers, but Epoch is different.

EPOCH—If you own the best set, only by Epoch can you confirm it.

EPOCH—Away with the tin can and cracked banjo reproduction, and install an Epoch.

EPOCH—Away with the drumminess, droniness, and huskiness of the average moving coil speakers.

EPOCH—The clearest, sharpest, cleanest reproduction—a marvel of accuracy and beauty.

EPOCH Moving Coil Speaker Models from £2/10 to £30.

EPOCH Moving Coil Speakers.—Models for every requirement and taste.

EPOCH Permanent Magnet Moving Coil Speakers.—Nine models from £3/15.

EPOCH Permanent Magnet Moving Coil Speakers Require no Mains or Batteries.

EPOCH Permanent Magnet Speakers are more Sensitive than most Energised Moving Coil Speakers.

EPOCH Energised Models are the Finest ever put on the Market.

EPOCH Super Cinema Speaker has Created the Biggest Sensation for Many Years.

EPOCH Super Cinema Model is many times as Sensitive as the so-called Supers.

EPOCH Super Cinema Speakers give Enormous Volume from a 1-watt Amplifier.

EPOCH Super Cinema Speakers are used on many 100-watt Amplifiers and never "rattle."

EPOCH Super Cinema Model is Standard on several Talkie Equipments.

EPOCH Super Cinema Model is already in use in over 200 Cinemas.

EPOCH Super Cinema are the only Moving Coil Speakers used in Large Theatres, unaided.

EPOCH Super Cinema Speakers provide alone the Upper as well as the Lower Register.

EPOCH—Other Moving Coil Speakers require the help of exponential horns to provide depth.

EPOCH—A list of many prominent cinemas using the Speakers supplied on request.

EPOCH Speakers are not Made of Tin or Aluminium Stampings, but are sound, solid, engineering jobs.

EPOCH Heartily Invite Comparison, on all counts, with any make, regardless of price or claims.

EPOCH—Don't accept our quality claims without verification, but don't accept any other maker's either.

EPOCH—Order: one on 7 days' approval, and test with a switch-over; the only real test.

EPOCH Moving Coil Speakers may be heard in our Demonstration Room Daily.

EPOCH—Our demonstration room is in the heart of London.

EPOCH—Its accessibility has been studied for the convenience of callers.

EPOCH—If you cannot call, write for booklet W.S.3, and approval terms.

EPOCH RADIO MANUFACTURING Co., Ltd., Farringdon Av. (near Ludgate and Holborn Circus). Phone: Central 1971. [8983]

Make Use of The Wireless AND RADIO REVIEW World DEPOSIT DEPARTMENT

A recent user writes:

"Please accept my thanks for the services rendered in the purchase of the eliminator which I have decided to keep. You can therefore forward the money to the seller with my thanks.

"I shall always praise your Deposit System which is the safest way of dealing with strangers that I know of."

W. H. THEWLIS,
49, Webster Street,
OLDHAM, Lancashire.

Full particulars of "The Wireless World" Deposit System are given on the first page of Miscellaneous Advertisements.

w.w.94-

"Could have been sold over a dozen times!"

A recent advertiser in
"THE WIRELESS
WORLD" writes as
follows:

"You may be pleased to know that the coils I advertised in 'THE WIRELESS WORLD' could have been sold over a dozen times.

"They were sold first post here on Thursday morning, and I had applications for them for a fortnight after."

W. A. Pelly,
Pierhead,
Eastbourne.

W.W.95

COMPONENTS, ETC., FOR SALE.

BELLING-LEE Panel Fittings are designed to give an expert finish to any home-constructed set; catalogue post free.—Belling and Lee, Ltd., Queensway Works, Ponders End, Middlesex. [0018]

COMPONENTS Lent on Hire.—Details from Alexander Black, Wireless Doctor, 55, Ebury St., S.W.1. Sloane 1655. [0329]

SOLDER, specially prepared for radio joints, 2ft. strip; 6d., post free.—C. O. Pattison, 548, Shields Rd., Newcastle-on-Tyne. [9716]

B.T.H. Rice Kellogg Moving Coil Speaker, 100-250 D.C., £3/10; Hegra moving coil speaker, 230 D.C., £2; 1930 B.T.H. pick-up and tone arm, £1/5; new music magnet, with valves, £5.—H. Spriggs, c/o Roselyon, Mount Park, Harrow, Middlesex. [9917]

R.I. Varley 14-28 Henry Choke, 10/6; Marconi Ideal, 4.1, 9/-; Igranic square law, 0.0005, 0.00015, with dials, 1/9 each.—Box 6631, c/o The Wireless World. [9894]

S.W. Kit Eddystone A.V. Unit, 14/6; Cydon 0.00015 extension, 9/6; 0.0003 Formo variable, 3/6; 2 Formo S.M. dials, 3/6; lot 28, or exchange for B.T.H. pick-up complete.—Wild, 33, Nottingham St., Sheffield. [9807]

FERRANTI A.F.3, 14/-; O.P.3c, 12/6; Ormond S.M. dials, 2/3; Eureka 0.0005 log condensers, removable spindles, 4/6; Mullard charger 2-6v. 1.5a., 40/-; ditto H.T. eliminator, 67/6, both for 200v. A.C.; new 2v. 120 actual Exide, 15/6; Leweos, Colvern aerial, split primary, 2/3; 6-pin bases, 1/-; copper screening boxes, 2/9; Marconi Junior transformer, 9/6; P.M.I. H.P. and L.F., 4/-; P.M.252, 8/6; Mullard 2 mfd., 2/-; 4 mfd., 3/6; Gambrell neutroverins, 2/3; all above guaranteed perfect.—W. Smith, 23, Blakelift Rd., St. John's, Worcester. [9915]

RADIO HOUSE, HUDDERSFIELD, issues the Reliability Wireless Guide, which will be sent post free upon request by Messrs. J. H. Taylor and Co., 15, Macaulay St., Huddersfield. [7823]

PART Exchange.—See our advertisement under Receivers for Sale.—Scientific Development Co., 57, Guildhall St., Preston. [0228]

1930 Keystone Ether Searcher; 15/6; wireless sets and spares supplied for cash or terms; Provident and other trade checks accepted.—Acacia Stores, 229-231, Upper Tooting Rd., S.W.17. [9925]

P625, 9/-; P.M.6, P.M.256, D.E.L.610, Cossor I.L.F.610, 3/6 each; Varley and Wearite H.F. chokes, 3/6 each; Wanted, M-L converter, 12-300 volts.—12, Alexandra Villas, Finsbury Park, N.4. [9923]

SURPLUS Bargains.—Cydon Mid-log condensers, 0.0005, 7/- each; ditto, 0.00025 reaction, 5/- each; Nicore transformer, 14/-; Lowe pick-up, 10/-; etc.—Smith, 3, Park Parade, Harlesden, N.W.10. [9921]

APPLEBY'S Bargains.

THE Following Slight Used Material is offered subject to sale; every article will be severely tested before despatch, and guaranteed in workable condition; items are nett cash and carriage paid in Great Britain.

RESIDUE of Transformers.—Ferranti A.F.5, 19/6 each; Ferranti A.F.3, Marconi Ideal, R.I. Straight Line, Hyperon, Ferranti O.P.1 and 2, all one price, 14/- each, limited number; Ferranti A.F.4 Royal (best model), Dymac, all one price, 10/- each, limited number; Marconi Popular, B.T.H. G.E.C., small Marconi Ideal, R.I. General Purpose, all one price, 8/6 each, limited number; Formo, Lissen, Eureka, Brandes, Igranic Shrouded, all one price, 5/6 each, limited number.

RESIDUE of R.C.C. Units.—Mullard, 9/- each; Cosmo, Dubuier, Magnum, with valve holder, all one price, 5/- each, limited number; Ediswan, 3/- each; Polar, 2/6 each, limited number.

RESIDUE of Pick-ups.—Woodroffe, 45/- each; R.I. Varley, 25/-, 20/- each; Brown, best model, 45/-, 30/- each, prices depending upon condition; Igranic Phonovox, Amphion Vivavox, G.E.C., Burndept, all one price, 14/- each, limited number.

RESIDUE of Condensers.—Ormond No. 3 S.L.F. and log, 0.0005 and 0.00035, with dials, all one price, 3/9 each; friction control model, 7/6 each, postage 6d. extra on singles priced 3/9.

APPLEBY, Number Forty-four, Chapel St., Marylebone, N.W.1 (four minutes from Oxford St., London.) [0338]

MICROPHONE, Marconi, heavy type moving coil, also Western Electric 50-Watt 511 type valve, as new.—Offers to A. Brasileiro, 33, Comeragh Rd., West Kensington, W.14. [9937]

BLUE SPOT 66K and Major Chassis, new, 27/6; P.M.2, 8/-; Igranic choke, 2/6; P.M.12 S.G., new, 15/-; Ormond 0.0005, 3/-.—Blair, 36, Hillhead St., Glasgow, W.2. [9942]

Mention of "The Wireless World," when writing to advertisers, will ensure prompt attention.

Components, Etc., for Sale.—Contd.

BLUE Spot 66K Unit, mounted in Squire cradle, 17/6; Marconiphone Ideal transformer, ratio 2.7:1. 12/6; Pye slow motion condenser, 6/6; also a lot of smaller parts; send stamped envelope for list.—Box 6681, c/o *The Wireless World*. [9910]

MICROPHONE, on stand, never used; 12/6.—Turner, 15, Elgin Av., London, W.9. [9875]

DESIGNER'S Surplus.—Brand new Magnavox M.C. speakers, 1 D.C. 220v., £4/10; 1 6v., £3/10, including step-down transformers; new triple gang Amso condensers, brass, cost £3/2, to clear £1/8; Pilot transformer, new, 7/6.—R. N. Wellington, Lulkins, Woodcock Hill Lane, Kenton. [9933]

M-L 40-watt Converter 200v. D.C. to 230v. A.C. 50c., new, unused, £8; 6v. Marconi M.C., £2/10; Brown Mascot speaker, £2; 8 new type Hydra 2 mid., 1/6 each.—10, Queensville Av., Stafford. [9930]

MARCONI Coil Speaker, 6v., 30/-; 4 P625 valves, 7/6 each; 2 P.M.6D, 5/- each; H.L.610, 5/-; new full emission, Ferranti A.F.5, 15/-; O.P.3C, 10/6; B.T.H. pick-up, latest type, 25/-.—Palmer, 183, Laburnum Grove, Portsmouth. [9926]

MISCELLANEOUS.

ALEXANDER BLACK,

THE Original Wireless Doctor, will call (London and Home Counties) and cure your set.

CONSULTATIONS by Appointment Without Obligation, sets installed, maintained, and brought up to date, gramophone pick-ups, eliminators, and Webson moving coil speakers demonstrated; purity reproduction specialists.

55, Ebury St., Victoria, S.W.1. Sloane 1655. [0277]

SCOTT SESSIONS and Co., Great Britain's Radio doctors, officially approved as wireless repairers by Radio Society of Great Britain and Wireless League; old sets of every type repaired, rebuilt, modernised; send set for immediate quotation.

SCOTT SESSIONS and Co.—New sets constructed with your or our components, guaranteed finest workmanship; we specialise in "The Wireless World" circuits; remember, we have satisfied customers throughout the British Isles and in three Continents; if you so desire, we will design and construct high grade apparatus to suit your special circumstances for quality, range and selectivity.—Tel.: Tudor 5326. Muswell Hill, London, N.10. [0262]

EASY Payments.—We supply, by easy payments, components, accessories, and sets, any make; 10% down, balance spread over 11 months.—Send list of requirements to London Radio Supply Co., 11, Oat Lane, London, E.C.2. [0337]

COMFORTABLE Digs. for Wireless Students Studying in London, good food; very moderate.—Moore, 41, Finborough Rd., South Kensington, London, S.W.10. 'Phone: Kensington 1427. [9857]

ENGINEERS, novice or expert, £300, £400, £500 per year or more is within your grasp; in our handbook "Engineering Opportunities," Prof. A. M. Low explains where the good posts abound; this handbook has shown the way to better things to over 20,000 of your fellows; it contains details of A.M.I.Mech.E., A.M.I.E.E., A.M.L.C.E., A.M.I.A.E., A.M.I.Struct.E., Matric. C. and G., G.P.O., etc., examines, outlines home study courses in all branches of electrical, mechanical, motor, and wireless engineering, and shows the unique advantages of our appointments department; why stay in the Hammer and File Brigade? Send for our free handbook at once, stating branch, post or exam. which interests you.—British Institute of Engineering Technology, 87, Shakespeare House, 29-31, Oxford St., London, W.1. [9912]

PATENT AGENTS.

PATENTS and Trade Marks, British and foreign.—Gee and Co. (H. T. P. Gee, Member R.S.G.B. and A.M.I.R.E.), 51-52, Chancery Lane, London, W.C.2. 'Phone: Holborn 1525. [0001]

REPAIRS.

SCOTT SESSIONS and Co., Great Britain's radio doctors; read advertisement under Miscellaneous column. [0263]

THE BARNES RADIO SERVICE—Repairs, rebuilding, demonstrations, radio gramophones and scratch filters; reproduction specialists; any distance.—53, High St., Barnes, S.W.13. Prospect 5633. [9705]

GUARANTEED Repairs by Experts.—Loud-speakers, headphones, cone units, pick-ups, any type, re-wound, remagnetised, and adjusted post free 4/-; transformers, from 4/-.—Howell, 91, Morley Hill, Enfield, Middlesex. [9555]

NEW PUBLIC ADDRESS and Broadcasting MICROPHONES

The Ideal Instruments for addressing a large Audience through Loudspeaker (via Valve Amplifier or L.F. Stages of Wireless Set), and for relaying Speech and Musical Entertainment to any Distance. Powerful Loudspeaker Reproduction with perfect Purity.



Hand Type, highly distance-sensitive, yet guaranteed entirely free from distortion or microphonic noises, absolutely silent background; far superior to ordinary Microphone Transmitters; for use with Valve Amplifier or Valve Set (through leads of Gramophone Pick-up if desired) at Open-air Meetings, in Cinema, Theatre or Concert Hall. Operates from 2 Volt tapping of I.T. Accumulator, through Microphone Transformer. Current consumption one-tenth Ampere. Provided with detachable Sound Collector, handle, hook for suspension, and a 9ft. silk connecting cord as illustration **16/6**



Pedestal Type, Highly Sensitive Microphone, as above described, provided with detachable sound collector and a 9ft. silk connecting cord, but fixed by rubber-cord suspension in nickel-plated frame on pedestal 11in. high; for mounting on Speaker's Platform, in Pulpit, on top of Camera Stand, or for suspension from ceiling, as illustration **25/-**

The above Microphones are rendered Directional by attaching the Sound Collector.



Microphone Transformer, special design to obtain best possible results from sensitive Microphones when connected to high-resistance phones, Loud Speaker, Valve Set, or Valve Amplifier; best Transformer made for clear speech with volume, modulation speech and music transmission, Public Address Microphones, etc.; Prim- and Sec. terminals fitted; full directions for use of Microphone and diagrams of connections free. Goods by return post **6/-**

FREDK. ADOLPH, Actual Maker, 'PHONE: Museum 8329, 27, Fitzroy Street, London, W.1.

SEND TO-DAY FOR OUR FREE 36-PAGE BOOKLET "SOUND ADVICE."

The Finest High-grade Speaker in the World

PERFECT RECEPTION FOR MUSIC LOVERS

BAKER'S "selhurst" RADIO

Super Power Moving Coil Speaker.

Office: 89, Selhurst Rd., S. Norwood, S.E.25. Works: 42, Cherry Orchard Rd., E. Croydon.

POWER CHOKES guaranteed **two months**

substantially built, for smoothing circuits in eliminators dealing with currents 100 to 300 milliamperes, inductance 30 henries, 8/6 post free

Note change of address

to any make of L.F. Transformer, Loudspeaker or Headphones. All repairs dispatched within **48 HOURS. TWELVE MONTHS' GUARANTEE** with each repair. 4/- Post Free. Terms to Trade.

TRANSFORMER REPAIR CO. Dept. W., 953, GARRATT LANE, Tooting, LONDON, S.W.17.

WANTED.

ALL Types of Electrical and Wireless Apparatus Purchased for Cash; large quantities only.—T. W. Thompson and Co., 17, Strutton Ground, S.W.1. [0331]

WANTED, "The Experimental Wireless," 1930 (February).—G. E. Stechert and Co., 2, Star Yard, Carey St., W.C.2. [9996]

O.P.M.3c, 50,000 ohm, Ferranti resistances.—W. Tipper, 1, Overton Bank, Leek, Staffs. [9914]

WANTED, copies "Wireless World," dated November 16 and 23, 1927.—Offers to Markham, 12, Avenue Pereire, Asnieres, Seine, France. [9906]

D.F. Instrument (Marconi), type 11a or later.—James, 47, Mercers Rd., N.19. [9902]

WANTED, in good condition, eliminator, Marconiphone D.C.7 or Atlas D.C.50.—Hearl, Patmyra Rd., Gosport, Deposit system. [9924]

WANTED to Purchase or Hire, several Marconiphone P.A. type seven-eight loud-speakers.—Giles, Thorpe, Norwich. [9919]

AGENCIES.

MANUFACTURER Requires Sole District Representatives for complete range, including portable sets, radiograms, eliminators, etc.—Write Box 6649, c/o *The Wireless World*. [9898]

RADIO—Spare time technical inspectors required in every town, U.K., to service sets on commission basis.—Write qualifications, credentials, present occupation, to Service, Box 6688, c/o *The Wireless World*. [9934]

EXCHANGE.

3A Kodak (postcard), with leather case, used once, cost £6/2/6, for Mullard Master Three Star, or similar set.—Box 6651, c/o *The Wireless World*. [9901]

S.G. Multiple Valve Portable, complete kit, partly assembled; cost £9, £6, or exchange electric gram. motor and pick-up, 230 volts A.C., or Magnavox X core.—Jackson, Lodge, Crookhill Hall, Conisbrough, Rotherham. [9929]

BUSINESSES & PROPERTY FOR SALE, TO BE LET, OR WANTED.

RADIO Business, well established, paying concern, living accommodation, low rent; genuine bargain, £650, including stock value £200, and other assets; situated south coast Devon.—Box 6614, c/o *The Wireless World*. [9861]

SITUATIONS VACANT.

WIRELESS Operating; fees payable after appointment; amateur Morse classes.—Manager, Wireless School, 21, Manor Gardens, London, N.7. [9378]

WIRELESS Services.—The premier telegraph college in the British Isles (established 34 years) gives a sound training to all students, with assured positions on qualification; fees are not disguised under expensive board-residence scheme, but are payable by easy instalments, if desired.—Apply for Prospectus, Dept. "W.W." The London Telegraph Training College, Ltd., Morse House, Earl's Court, S.W.5. [9877]

TWO Service Engineers Required, must be well educated, experience with mains receivers and amplifiers essential; state salary required.—Box 6636, c/o *The Wireless World*. [9897]

SITUATIONS WANTED.

ENERGETIC Youth, 21, desires situation service man, or similar post, 2 years' experience, neat; North preferred.—Box 6675, c/o *The Wireless World*. [9903]

WIRELESS Engineer Desires Change, experienced design and manufacture of sets and battery eliminators, knowledge of talkie installation, preference for research and development work.—Box 6674, c/o *The Wireless World*. [9904]

BOOKS, INSTRUCTION, ETC.

TELEVISION—The complete authorised book on television (Baird Experimental) transmission and receiving is now ready; order "Television To-day and To-morrow" (Moseley and Barton Chapple), 7/6 net.—Pitman's, Parker St., Kingsway, W.C.2. [9309]

STEP by Step Wireless.—A complete course of instruction for wireless engineers; send 1/- for first 4 weeks.—Clifford Pressland, A.M.I.E.E., Hampton-on-Thames. [0195]

believe to be thoroughly reliable.

INDEX TO ADVERTISEMENTS.

Adolph, Fredk	PAGE 9	Hughes, F. A. & Co., Ltd.	PAGE 1	Six-Sixty Radio Co., Ltd.	PAGE 3
Appley, E. Hetherington	6	Imperial Airways, Ltd.	1	Standard Telephones & Electric Co., Ltd.	Cover iii.
Baker's "Selhurst" Radio	9	London Electric Wire Co. & Smiths, Ltd.	4	Supremus Specialities, Ltd.	7
Burne-Jones & Co., Ltd. (Magnum)	10	Marconiphone Co., Ltd.	Cover i.	Telegraph Condenser Co., Ltd.	2
Carrington Manf. Co., Ltd.	Cover i.	McMichael, I., Ltd.	10	Telson Electric Co., Ltd.	Cover i.
Burton, C. F. & H.	Cover i.	M-L Magneto Synd. Ltd.	Cover iv.	Thomas, Bertram	5
Celestion, Ltd.	3	Mullard Wireless Service Co., Ltd.	Cover iv.	Transformer Repair Co.	9
Cole, E. K., Ltd.	3	Overseas Trading Co.	6	Ultra Electric, Ltd.	Cover i.
Day, Will, Ltd.	6	Parker, W. H.	6	Varley (Oliver Pell Control, Ltd.)	5
Dubilier Condenser Co. (1925), Ltd.	3	Paroussi, E.	6	Westinghouse Brake & Saxby Signal Co., Ltd.	Cover iii.
Eastick, J. J., & Sons	6	Persens Manf. Co., Ltd.	6	Weston Electrical Instrument Co., Ltd.	3
Edison Swan Electric Co., Ltd.	6	Player's	6	Wilkins & Wright, Ltd.	2
Electradix Radios	6	Potter, H. B., & Co., Ltd.	6	Wingrove & Rogers, Ltd.	6
Ever Ready Co. (G.B.), Ltd.	6	Radiogramophone Development Co.	Cover iii.	Wright & Weaire, Ltd.	6
Exide Batteries	6	Rigby & Woolfenden	6	Yates, Sutton, Ltd.	6
Hayberd, F. C., & Co.	6	Rothermel Corporation, Ltd. (Centralab)	10		
Holzman, L.	Cover ii.	Rowley, Thomas A., Ltd.	7		



It would be FATAL to lose CONTROL

Barbed wire—trenches—dug-outs—a field set and a thin strand of wire.

The difference between control and lack of control may spell life or death to an entire brigade.

It's a far cry from No Man's Land to the comforts of your home.

But even in your radio set . . . control plays a vital part . . . and it has been the privilege of CENTRALAB to furnish the volume controls of millions of radio receivers.

Is your radio—CENTRALAB equipped?



Write for free Booklet, "Volume Controls, Voltage Controls, their uses."

Centralab

THE ROTHERMEL CORPORATION LTD.,
24, Maddox Street, London, W.1.

'Phone: MAYFAIR 0578/9.

Continental Sales Office:
27, QUAI DU COMMERCE, BRUSSELS, BELGIUM.

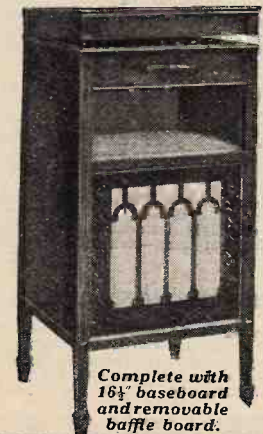

Cameo Cabinets

for your Radiogram also

PORTABLES,
TRANSPORTABLES,
LOUD SPEAKER CASES,
ETC.

Send for complete booklet or call and see full range at our showrooms.

Oak. Mahogany.
£7 : 10 : 0 £7 : 15 : 0

CARRINGTON MANUFACTURING CO., LTD.,
24, Hatton Garden, London, E.C.1.

Phone: Holborn 8202.
Factory: Gamco Works, Sth. Croydon.

Complete with 16 1/2" baseboard and removable baffle board.

P.C posted to-day will bring you by return particulars of how you can operate an

A.C All-Electric Receiver from a

D.C supply main, by using the



D.C. to A.C. ROTARY TRANSFORMER

Write for Pamphlet 596/1.

M-L MAGNETO SYND. LTD.
Radio Dept.
COVENTRY.
Telephone: 500r.

Can be supplied to run from any voltage 12-250 V.D.C. 40 watt model £13; 85 watt model £19.
Recommended and used by Philips Radio, Marconiphone, Burndept, Kolster-Brandes, M.P.A., etc., etc.

DICTIONARY of WIRELESS TECHNICAL TERMS
(1926)

Compiled by S. O. Pearson, B.Sc.

Issued in conjunction with "THE WIRELESS WORLD."

THIS volume contains concise definitions of terms and expressions commonly used in wireless telephony and telegraphy, and serves as a guide to all those interested in wireless who come across, from time to time, unfamiliar words in their reading. Well illustrated and cross-referenced.

Price 2/- net. By post 2/2.

From leading booksellers or direct from

ILIFFE & SONS LTD.,

14, W. 48, Dorset House, Tudor Street, London, E.C.4.

Mention of "The Wireless World," when writing to advertisers, will ensure prompt attention.

If you have A.C. mains

in your house, you have the cheapest and most reliable supply of current for your set, and



METAL RECTIFIERS

enable you to adapt this supply in the simplest and most efficient way.

Here are three of the popular units—for high tension, low tension, and grid bias—and there are, of course, several other types, suitable for all radio purposes.

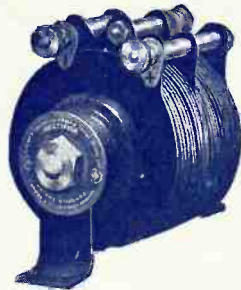

All the leading radio manufacturers are now incorporating the Westinghouse Metal Rectifier in their eliminators, chargers and mains sets. You can do the same.

Full details, circuits and instructions are given in our 32-page book,

"The All Metal Way, 1930."

Send a 2d. stamp with your name and address for a copy, to:—

The Westinghouse Brake & Saxby Signal Co., Ltd.,
82, York Road, King's Cross, London, N.1.

PATENTS

STANDARD TELEPHONES AND CABLES LIMITED

Beg to announce that they are the owners of more than 60 patents relating to wireless broadcast receiving sets.

These include amongst many others:—

- Superheterodyne
- Push-pull
- Split Loop
- Hartley Oscillator
- Mains Receivers
- Free Grid Bias
- Gang Condensers
- Volume Control with Constant Impedance
- Folded Exponential Horns
- and
- (in conjunction with Electrical Research Products Inc.)
- Combined Gramophone and Radio

AND THAT they are willing to grant licences under these patents and future inventions of their own and their associated Companies to approved British manufacturers, who are invited to apply for further particulars and conditions to:—

STANDARD TELEPHONES & CABLES LTD.
Room 717, Bush House, Aldwych, W.C.2

THE ALL-ELECTRIC R.G.D. RADIOGRAMPHONE



for A.C. or D.C. MAINS with COIL-DRIVEN SPEAKER as described in "Wireless World," March 26th.

A highly finished Instrument of quality.

We shall be pleased to supply literature on application. Trade agencies vacant.

Mahogany £80 Oak £75

The Radiogramophone Development Co.,
72, MOOR STREET, BIRMINGHAM.

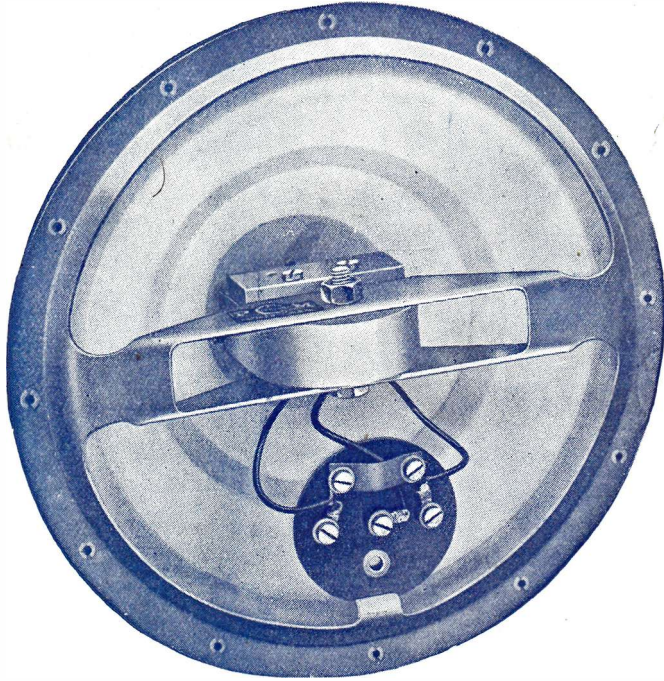

THE MULLARD SPEAKER UNIT

The Unit with the
 "brilliant performance"
 which formed part of the
 most successful experiment
 recorded in "The Wireless
 World" issue June 18th.

Mullard

MASTER · RADIO

Price - £1.18.6

Advt. The Mullard Wireless Service Co., Ltd., Mullard House, Charing Cross Road, London, W.C.2.

Printed for the Publishers, ILIFFE & SONS LTD., Dorset House, Tudor Street, London, E.C.4, by The Cornwall Press Ltd., Paris Garden, Stamford Street, London, S.E.1.

Colonial and Foreign Agents:
 UNITED STATES—The International News Co., 131, Varick Street, New York. FRANCE—W. H. Smith & Son, 248, Rue Rivoli, Paris; Hachette et Cie, Rue Réaumur, Paris.
 BELGIUM—W. H. Smith & Son, 78, Marche aux Herbes, Brussels. INDIA—A. H. Wheeler & Co., Bombay, Allahabad and Calcutta. SOUTH AFRICA—Central News Agency, Ltd.
 AUSTRALIA—Gordon & Gotch, Ltd., Melbourne (Victoria), Sydney (N.S.W.), Brisbane (Queensland), Adelaide (S.A.), Perth (W.A.), and Launceston (Tasmania).
 CANADA—The American News Co., Ltd., Toronto, Winnipeg, Vancouver, Montreal, Ottawa, St. John, Halifax, Hamilton; Gordon & Gotch, Ltd., Toronto; Imperial News Co., Toronto, Montreal, Winnipeg, Vancouver, Victoria. NEW ZEALAND—Gordon & Gotch, Ltd., Wellington, Auckland, Christchurch and Dunedin.

The Wireless World

AND
RADIO REVIEW
(18th Year of Publication)

No. 568.

WEDNESDAY, JULY 16TH, 1930.

VOL. XXVII. No. 3.

Editor: HUGH S. POCOCK.

Assistant Editor: F. H. HAYNES.

Editorial Offices: 116-117, FLEET STREET, LONDON, E.C.4
Editorial Telephone: City 9472 (5 lines).

Advertising and Publishing Offices:

DORSET HOUSE, TUDOR STREET, LONDON, E.C.4.

Telephone: City 2847 (73 lines). Telegrams: "Ethaworld, Fleet, London."

COVENTRY: Hertford Street.

Telegrams: "Cyclist, Coventry."

Telephone: 9210 Coventry.

BIRMINGHAM: Guildhall Buildings, Navigation Street.

Telegrams: "Autopress, Birmingham."

Telephone: 2970 and 2971 Midland.

MANCHESTER: 260, Deansgate.

Telegrams: "Mite, Manchester."

Telephone: 8070 City (4 lines).

GLASGOW: 101, St. Vincent Street, C.2.

Telegrams: "Mite, Glasgow."

Telephone: Central 4857.

PUBLISHED WEEKLY.

Subscription Rates: Home, £1 1s. 8d.; Canada, £1 1s. 8d.;
other countries abroad, £1 3s. 10d. per annum.

Entered as Second Class Matter at New York, N.Y.

As many of the circuits and apparatus described in these pages are covered by
patents, readers are advised, before making use of them, to satisfy themselves
that they would not be infringing patents.

CONTENTS OF THIS ISSUE.

	PAGE
EDITORIAL VIEWS	51
D.C. FOREIGN LISTENERS' FOUR. BY F. H. HAYNES	52
MUSICAL OSCILLATOR. BY R. RAVEN-HART	58
LABORATORY TESTS ON NEW APPARATUS	60
CURRENT TOPICS	62
INSULATORS TESTED: (2) KERAMOT. BY W. H. F. GRIFFITHS	63
BRIGHTER TELEVISION IMAGES	65
WIRELESS THEORY SIMPLIFIED: PART XXXVII. BY S. O. PEARSON	66
BROADCAST BREVITIES	69
CORRESPONDENCE	70
READERS' PROBLEMS	71

FROM D.C. TO A.C.

Information which the Wireless Public Wants.

THE change over from direct to alternating current throughout the country, which is part of the general electricity scheme, must come gradually, and there can be no date of inauguration, as it were, when the whole country will suddenly wake up to find that D.C. supplies have disappeared. Is it necessary, however, that the public should be left so largely in ignorance of the date of a proposed change in any particular district? It is of the utmost interest and importance to the user of wireless apparatus and to the supplier in each area that the information should be available as to whether the change to A.C. will come in a month or so, or a year or two.

Nobody is likely to invest in a new set if he has reason to believe that within a month or two he will have electricity available in the house, or his D.C. supply will be changed to A.C.

Whenever we have made enquiries from electricity

supply companies or other authorities concerned, we have found a reticence to give any helpful information on the question of the date of change, although we have been readily supplied with other facts.

Is there, perhaps, some political reason why the companies are keeping back this information until the last minute, or is it merely officiousness on their part? We cannot believe that the arrangements are so indefinite that it is not possible even to give approximate dates as to when the change will take place.

Next to those who make use of electricity in large quantities for power purposes, the wireless user and supplier constitute probably the section of the public most concerned in the change over, and we would, therefore, urge supply companies to issue, as early as possible, information giving at least some approximate indication of the date of change, even though the precise date must for the present remain an unknown quantity. There could be no better medium through which to issue this information than our own journal, and we shall be glad to be of service to any supply company by publishing such particulars as they care to forward.

o o o o

DUPLICATING 5XX.

I N *The Wireless World* of June 25th, under the title "Duplicating 5XX," we urged that the importance of 5XX should be maintained and that the B.B.C. ought to make it quite clear that there was no intention of permitting the station to fade out or become of secondary importance as the regional scheme developed. We also put forward the suggestion that, if there was yet time, the B.B.C. should consider making application for a second long wavelength in order to be able to duplicate the programmes on the long wavelengths also. Whilst many letters have been received from readers supporting such a proposition, Mr. J. A. Hall, of Bedford, who contributes to the Correspondence columns of this issue, views with apprehension a suggestion that another long-wave station should be put on the air in this country, because he fears that by doing so we shall rob ourselves of a choice of programmes on long wavelengths from abroad. The long-wave stations, it must be remembered, have a considerable range, so that in the interests of quality reception it is even more essential that there should be no overlapping than is the case with the shorter wave transmitters. A second 5XX can, therefore, only be contemplated provided that there is room for it in the European ether without overlapping and so interfering with the reception of other long-wave stations.

D.C. FOREIGN LISTENER'S FOUR

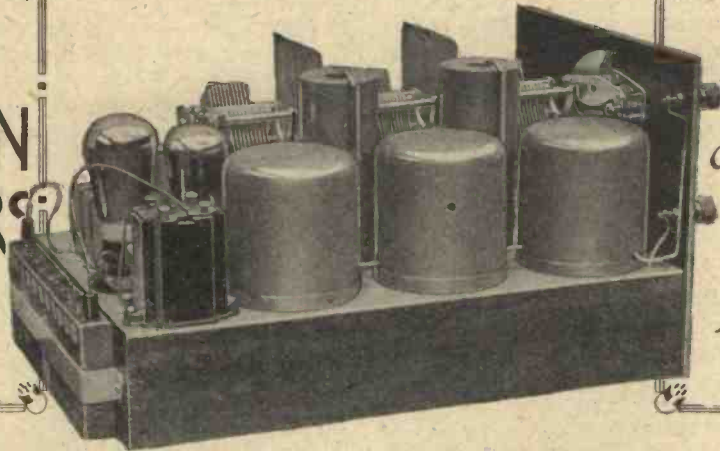

Battery and Mains Operated Models

Single-dial Tuning with Ganged Coils and Condensers.
Critical Adjustment of Amplification up to Point of Oscillation.

By F. H. HAYNES.

IN the circuit diagram of the all-battery operated set the values given to the screen and anode feed resistances used for purposes of decoupling may seem excessive. As the current passed is small, increase in the value of these resistances is of little consequence in so far as dropping volts is concerned. By the use of high-value resistances, however, a form of low-frequency oscillation, so often met with in two-stage H.F. amplifiers, is avoided, for it must not be overlooked that some degree of detection in the H.F. circuits is unavoidable, and for this reason decoupling values must be taken that will prevent feed-back of audio-frequency currents to the common H.T. source. As a result of the high reactance of the coupling condensers to audio-frequency currents, combined with the low reactance of the tuning coils as a path to earth, detected signals are not passed on from plate to grid. In that battery-operated S.G. valves require a bias of less than a volt, but a small input voltage can be handled, and it is owing to the possibility of overloading the second S.G. valve, and the consequent rectification that will result, that not only must H.F. decoupling be used in addition to the feed chokes, but it must, moreover, be generous. L.F. decoupling is not so essential in the case of the A.C./S.G. type valves adopted in the all-mains set, owing to their ability to handle probably six times the signal voltage of other valves. Their anode current is also many times greater, so that where a feed resistance of 10,000 ohms might only drop 10 volts in respect of the battery valves, some 40 volts of the limited H.T. potential would be thrown away with the A.C./S.G. valves. In addition,

we must bear in mind that anode voltages up to 200 are permitted with the A.C./S.G. type.

To avoid overrunning the S.G. valves when the potentiometer is set to give maximum screen volts, a voltage-limiting resistance is connected in circuit, this being related in value to that of the potentiometer, and permitting amplification to be brought up to the maximum and where regeneration just occurs. It will be noted that the anode leads are tapped into the tuned circuits so as to include practically the entire coil in order that the low value of grid to anode capacity of the S.G. valves may be sufficient to bring about oscillation as well as using the couplings in a way that gives best amplification.

Bearing in mind the few constructional hints already given, assembly will be quite straightforward. It will be found best to locate exactly the bases of the coil screens, and, placing the coils in position, drill through the holes required for the leads by reference to the terminal numbers. These are given in one of the theoretical circuits as well as in the practical wiring diagram.

In spite of the use of the metal base plate, a wire is brought through from the centre of each coil base and ultimately soldered on to the earthed metal casing of the condensers associated with the stage. Alternatively, these through earth connections may be conveyed by 4B.A. nut-and-bolt fixings.

The thin-walled brass tubes which convey the anode leads take up their vertical positions by being flooded round with solder where they enter the base plates of the screening boxes which surround the chokes. These boxes may be easily made from thin tin plate, and a

*E*ASY construction combined with a due regard to the cost of the components are outstanding features of this design. Distant stations are readily received by the operation of a single dial tuning, while the trimming and volume controls are used to bring the receiver into a highly sensitive condition.

Descriptive details appeared in last week's issue and the present article covers the process of construction. The layout adopted may be followed for either mains- or battery-operated sets and forms a basis which, by simple modifications, lends itself to the construction of more ambitious receivers.

D.C. Foreign Listeners' Four.—

covering of aluminium plate will prevent rust should the tinning have been removed in cleaning after soldering. Although the set will work quite well omitting these screening boxes and the screens around the valves and anode leads, it was found that the potentiometer control could be rotated farther in the direction of higher screen voltage and higher magnification than was the case when these screens were removed.

Distribution of Components.

With the H.F. chokes in position, the various condensers can be dropped in between them while the feed resistances and chokes can take up positions near where the valve-holder screws come through the clearance holes in the base. Each condenser can be identified from the practical wiring diagram, and it will be noted that the output feed condensers are on the top side of the base, so as to avoid the fitting of extra terminals for the loud speaker. Only one output condenser is required with the all-battery set, one of the loud speaker connections being picked up from a screw on the earth plate. Although not shown in the model which formed the subject for the photographs accompanying this description, the aerial circuit trimming condenser is best attached in the position shown in the drawings, being immediately above the potentiometer.

The coils are best screwed finally in position with the length of $\frac{1}{2}$ in. brass passing through the switch bars. This switch rod passes freely through the sides of the coils, and there is no objection to slightly enlarging the holes in the coil formers with a rat-tail file. Note that the grub screws securing the switch bars are best on the opposite side of the coil to the feed condensers, so that the rotation of the operating knob is not restricted. In inserting the switch rod, about $\frac{1}{4}$ in. should protrude on

the inside of each former in turn, on to which the bakelite switch bars can be dropped and the rod pushed through. When the set is finally finished and it is no longer necessary to withdraw the switch rod, a short flexible wire is soldered to it within the second coil container and earthed under one of the holding-down screws. The coil screens may be of copper or aluminium, both metals being good conductors, a necessary

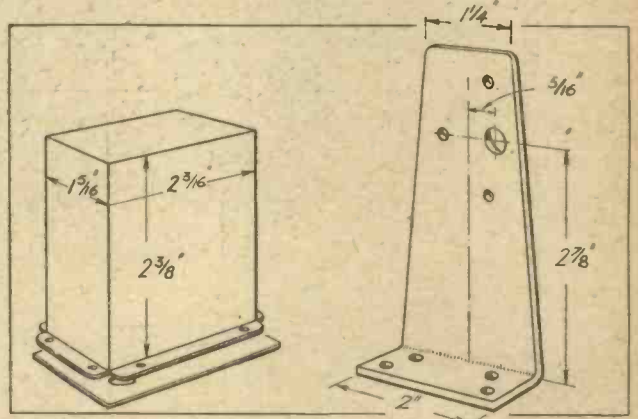

Constructional details of the tin plate boxes which cover the H.F. chokes. The anode lead screening tube is soldered into the hole shown in the bottom plate. Support for the end of the variable condenser assembly is provided by an aluminium bracket.

requirement when the screening is moderately near to the windings.

Carefully shaped leads bestow no advantage when proceeding with the wiring. Run the filament leads first, earthing the L.T. negative to the metal base-plate at both ends of the set. Resin-cored solder, Fluxite, and a clean iron of medium size are the best aids to good wiring. Use No. 20 wire for the filament circuits, while all other leads may be either No. 24 or No. 26, run by the shortest routes in small-gauge sleeving. It is best to wire the grid, screen and anode circuits following the filament wiring, as these are the least accessible. Care is needed to avoid touching the resistance wire when soldering to the feed resistances. The tags of these resistances being covered with bakelising material, it will be found that the solder will run quite readily. Every condenser beneath the baseboard, except No. 8, has one side earth connected by turning over a terminal tag and soldering it to the metal case. A wire is then run round all these points, including also the choke screening boxes. By-pass condensers connected in the anode circuit of the detector are soldered on to the two tags of the choke coil, and their centre point earthed. It is as well to wrap these condensers in insulating cloth.

The method of wiring in circuit the gramophone pick-up is shown in the diagram on page 34. In making use of a single-pole switch for this purpose it

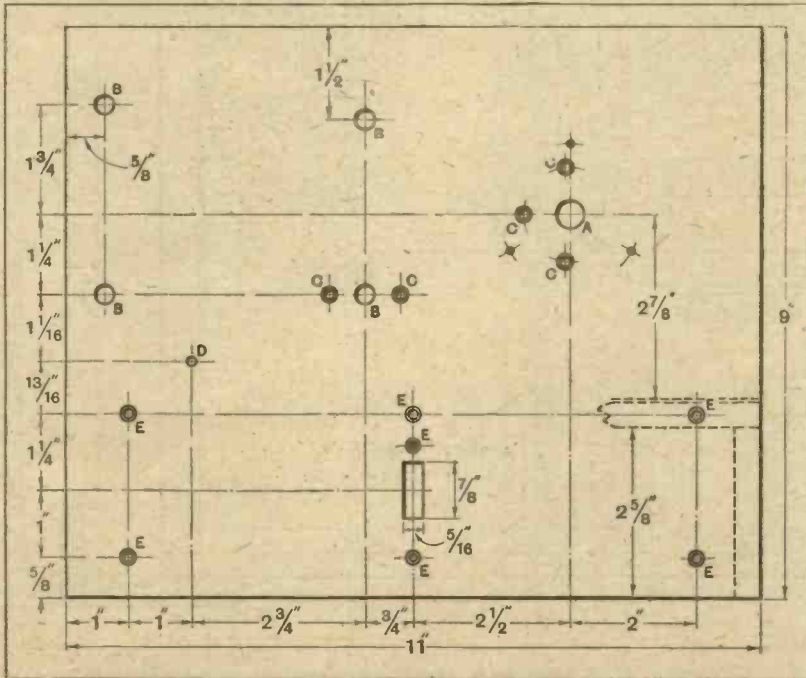

Drilling details of the front panel. Sizes of holes A, 7/16 in. B, 5/16 in. C, 5/32 in. and countersunk. D, 5/32 in. E, 1/8 in.

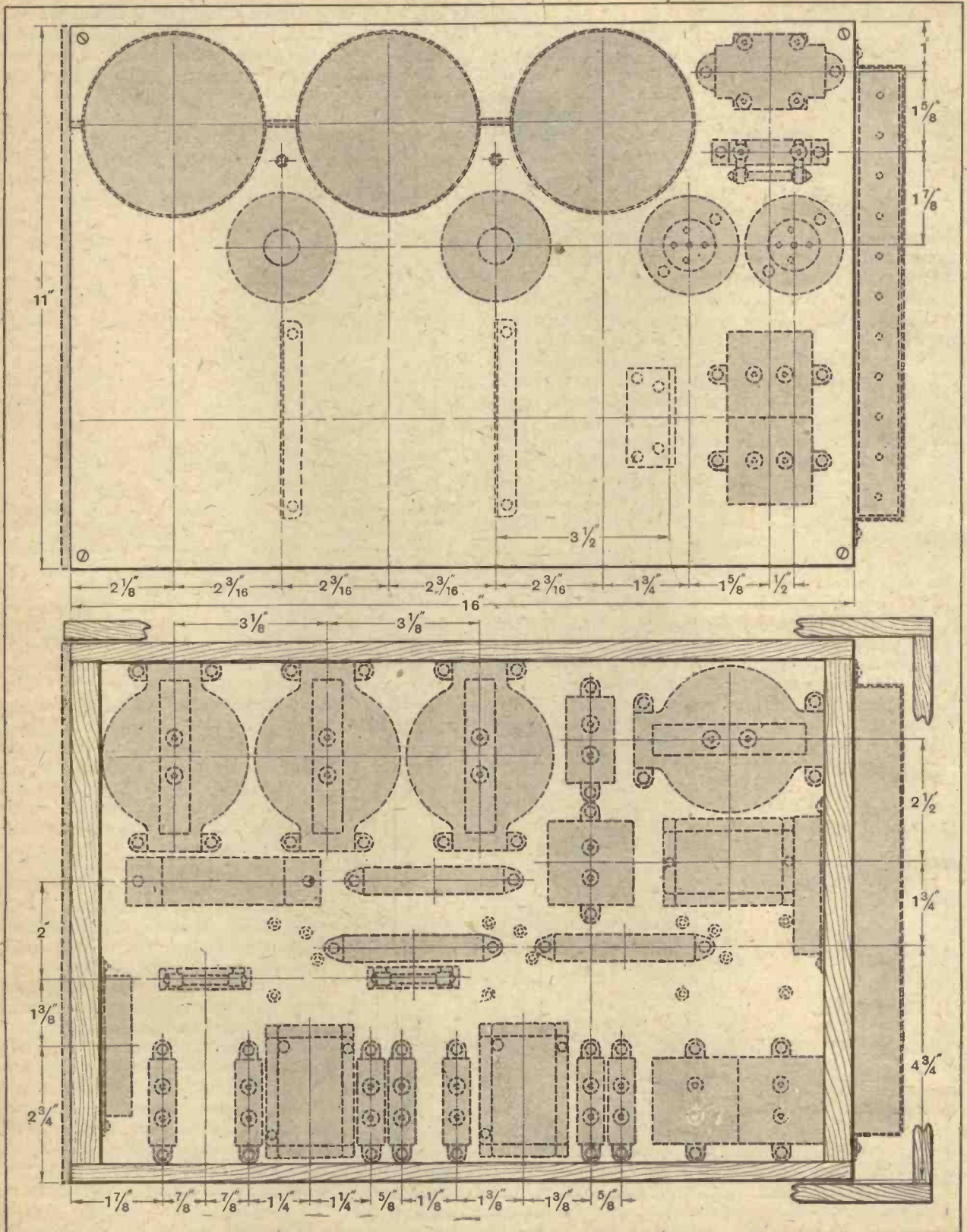

Dimensional layouts of the apparatus on the top and underside of the base box. Constructional details of the woodwork are also shown.

D.C. Foreign Listeners' Four.—

will be noted that the pick-up is shunted by the grid condenser, but the capacity is too small to produce a noticeable effect on reproduction. If the pick-up used is rated to give more than 1 volt peak output a 1.5 volt grid cell should be interposed in series with the 10,000 ohm feed resistance. An additional contact on the

through the series-connected heaters with a pair of carbon filament Robertson lamps, thus limiting the current to 1 ampere. The resistance of the filament of this type of lamp is much higher when cold, and they should, therefore, be tested on the mains and in circuit with an ammeter before being fitted to the set, when the value of the current should not exceed 1.1 ampere. Although the heaters are entirely separate from the smoothed H.T. supply, a number of series resistances adjust the potential of each cathode to that of the associated heater, at the same time creating the necessary biasing potentials. Tests were applied with a high-resistance voltmeter between each heater and cathode when making up the resistances, so as to ensure the avoidance of a potential difference. In calculating the values of these resistances, allowance must be made for the exact resistance of the chokes, while the current passed by each valve stage increases with each valve stage until the minus side of the smoothed H.T. is reached. Success in wiring to this circuit depends upon the facility for making up the necessary resistances and the measuring with micrometer and high-value series resistance of the potentials created in the various parts of the circuit.

Condenser Adjustments.

Reverting to the simple sets using battery valves, but few observations are necessary on their operation. Assuming the aerial to be about 60 ft. in length and the earth lead moderately short, a series condenser of 0.0001 mfd. will be required in the lead to the aerial terminal, as shown in the circuit diagrams. Slightly slacken the grub screws holding the moving plates of the condensers and swing them all round to zero, so that the plates fall in line by coming into contact with the rods of the condenser. After having tuned in a powerful station, find a very weak distant station, and with the

trimming condenser set to a mid-position, force round the plates of the aerial condenser to the position of maximum signal. If the receiver breaks into oscillation turn back very slightly the setting of the potentiometer away from the position of maximum. As the moving plates are earth-connected, they can be adjusted to the posi-

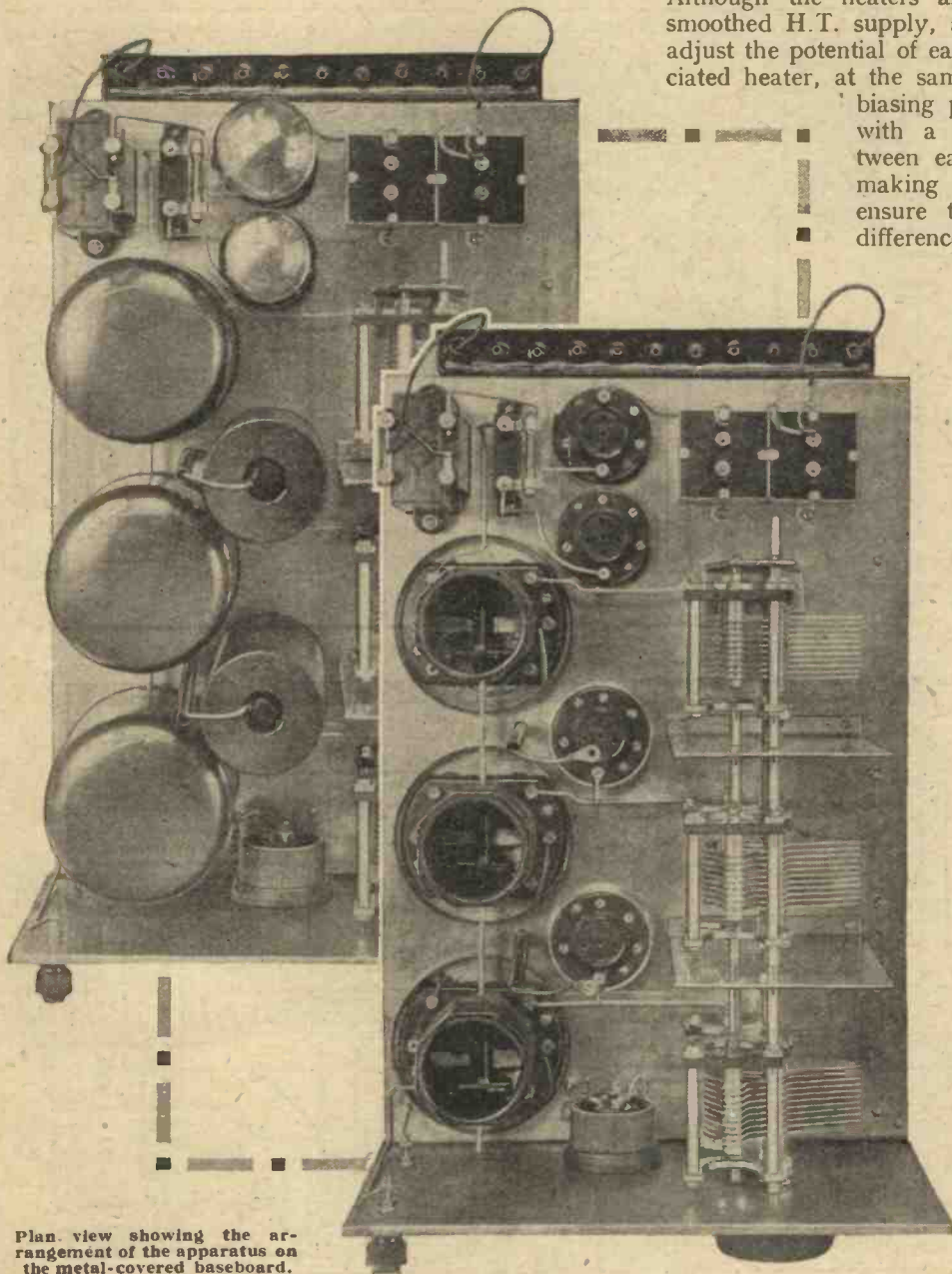

Plan view showing the arrangement of the apparatus on the metal-covered baseboard.

gramophone switch may be connected to break the L.T. positive lead where it feeds the two H.F. valves.

Before proceeding with the construction of an all-mains operated set it is worth while first wiring up to the L.T. operated circuit. In the all-mains circuit it will be noted that the unsmoothed mains supply is fed

D.C. Foreign Listeners' Four.—

tion of best ganging while receiving a distant station, and a very slight displacement of the middle and rear condenser sections may be advantageous. Always aim at producing a condition of oscillation with maximum screen voltage, and as the condensers are brought nearer into step the potentiometer will serve as a critical reaction

control. As the values of the coils are accurately matched, the second and third condensers will move together within practical limits, while the aerial trimmer will compensate for the running out of step produced by the aerial capacity when tuning across the condenser scale. This arrangement is preferable to the setting of trimmers on each condenser, the adjustment of which is

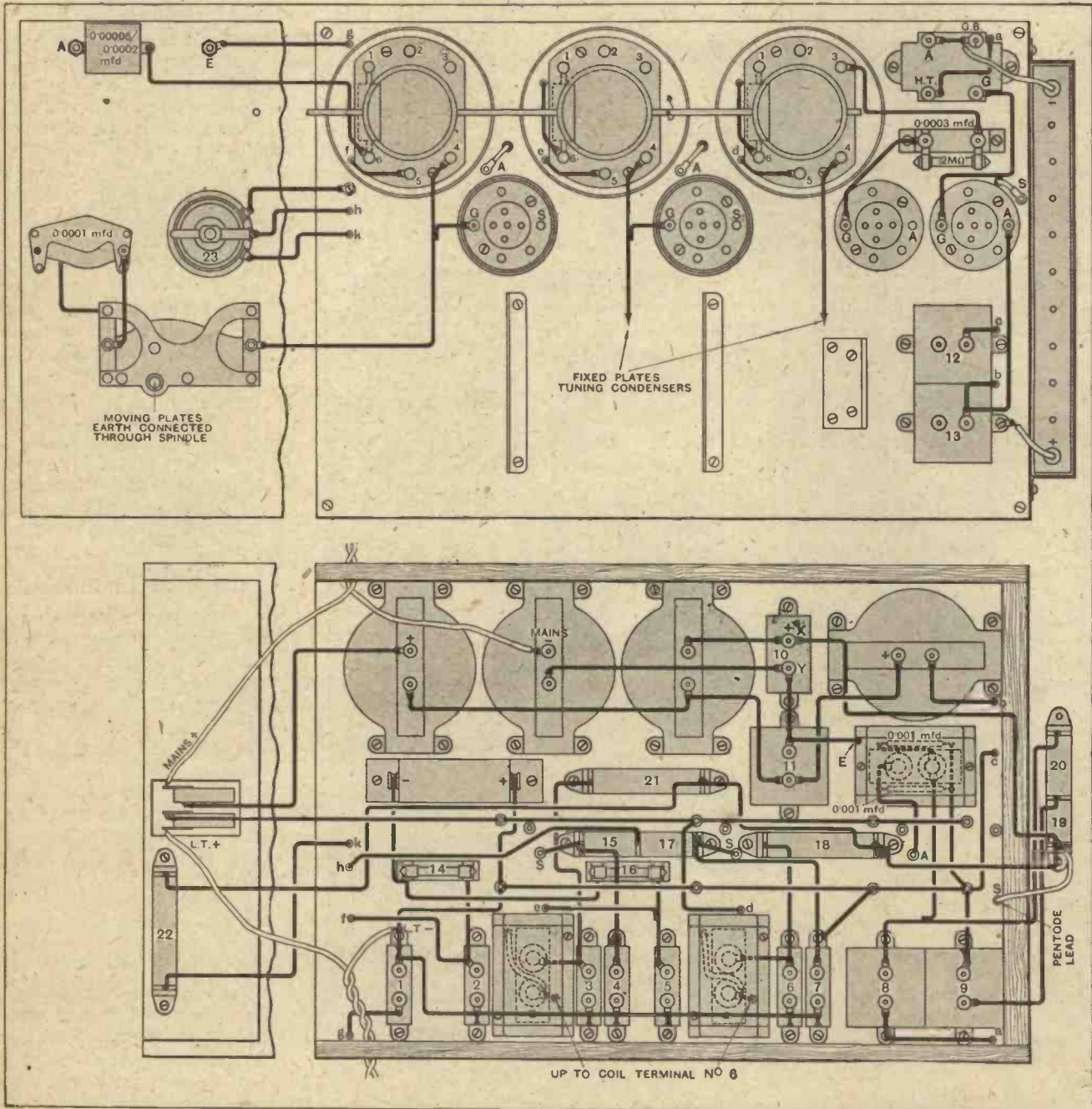

Practical wiring diagram. (1) Condenser in earth lead, and only included when using a mains H.T. supply. (2) Grid bias decoupling condenser in first tuned circuit. (3) First anode by-pass condenser. (4) First screen decoupling condenser. (5) Second grid bias decoupling condenser. (6) Second anode by-pass condenser. (7) Second screen decoupling condenser. (8) Feed condenser in L.F. transformer circuit. (9) Decoupling condenser in detector anode circuit. (10, 11) Condensers in D.C. eliminator. (12) Condenser on earth side of loud speaker only necessary with a mains H.T. supply. (13) Loud speaker feed condenser. (14, 16) Grid circuit decoupling resistances. (15, 17) Decoupling resistances in screen leads. (18, 21) Decoupling resistances in anode circuit. (19, 20) Decoupling and feed resistances in detector anode circuit. (22) Screen voltage limiting resistance. (23) Screen voltage control resistance.

D.C. Foreign Listeners' Four.—

only strictly correct at one setting, while the avoidance of an increase in the minimum capacity of the condensers considerably increases the tuning range. The fitting of a good geared dial¹ is an advantage, for on test this set gave ten stations above 5GB in the broadcast band on the loud speaker when connected to a loft aerial. Eight long-wave stations in addition to 5XX should be easily received after dark. Increased signal strength results from the use of a pentode working with the limited H.T. potential, and the quality obtained with certain loud speakers to which it is suited² will meet with the approval of the majority of listeners. If the more correct arrangement of using a centre-tapped output choke for the pentode is adopted, decoupling of the output stage must be introduced, with an additional choke and condenser.

The containing cabinet³ is a simple mahogany box into which the receiver will slide, which provides protection to the apparatus contained under the base. Flexible leading-out wires pass out at the back to the batteries or mains. A pair of screws in a fillet will secure the top edge of the panel, while others in the sides will hold in the base. Leave the panel projecting by $\frac{3}{2}$ in. above the polished front edge of the cabinet.

As it is invariably the practice of readers to modify designs to suit their own requirements, or to make use of apparatus which they may have to hand, the possible changes are briefly mentioned. The set can be readily constructed for A.C. working by the use of a base deep enough to accommodate the mains transformer, for which details were given in the earlier articles. If other bridging condensers are used to those shown, care must be taken to see that there is sufficient room to accommodate them and that the woodwork is sufficiently deep should they be of greater height. Where extreme selectivity is required, the inclusion of an additional H.F. stage exactly similar to those provided is an easy matter, and should be followed by an anode bend detector resistance coupled to a first L.F. stage. This may be followed by a resistance or a transformer coupling to an output valve working with a generous grid bias. As so much interest is being taken in the use of band pass filters, it may be mentioned that the form of layout here adopted is readily adaptable to the inclusion of band-pass tuning.⁴ Two additional tuning condensers will need to be carried on the common shaft, and two more tuning coils will need to be set up in line with the three at present shown. In the event of a high-voltage anode supply being available, and the use of an indirectly heated detector valve capable of working with a zero grid potential, power grid detection may be adopted in the manner shown in recent articles.

All the arrangements cited here have been tested, using the coil and condenser assembly shown in this article. In the course of these tests it became obvious that a trimming condenser was required only across the con-

denser associated with the aerial circuit, and that this should be operated on the front of the panel so that the greatly increased amplification resulting from critical balancing could be obtained.

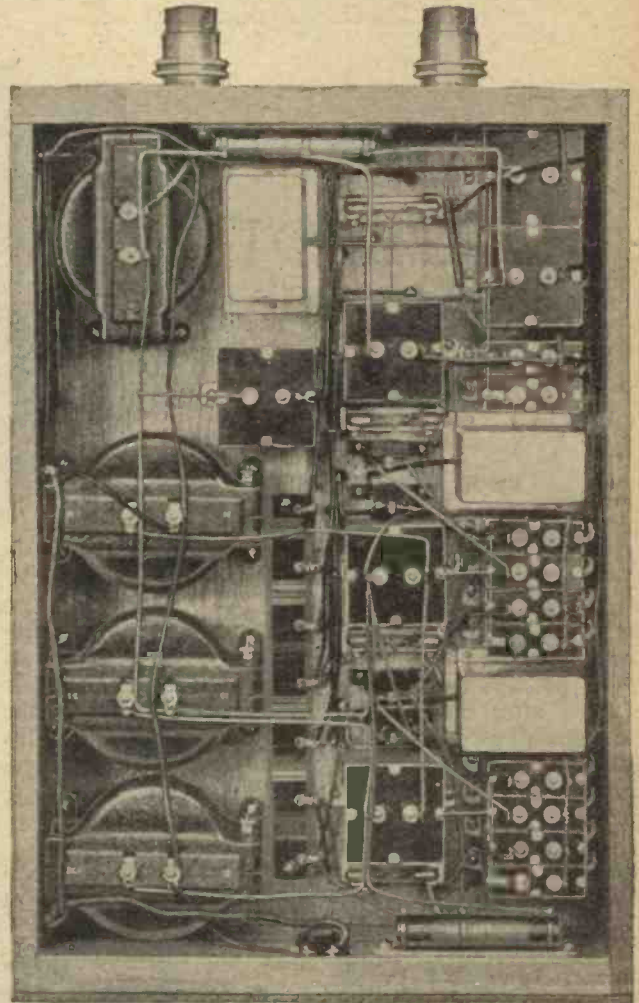

Under base view of the receiver wired for all D.C. mains working in accordance with the circuit shown on page 34.

Six-volt valves are to be recommended in view of the increased output to be obtained from the last stage. Alternative battery valves to those recommended in the circuit diagrams are as follow:—

H.F. Stage.—2-volt: Mullard PM.12, Marconi or Osram S.215, Mazda 215.S.G. 4-volt: Mullard PM.14, Marconi or Osram S.410. 6-volt: Marconi or Osram S.610. Owing to the increased anode current of this valve and also the S.410, as compared with those shown in the circuit diagram, the feed resistances should be reduced to 5,000 ohms.

Detector.—2-volt: Mullard PM2DX, Marconi or Osram L.210, Mazda L.210. 4-volt: Mullard PM4DX, Marconi or Osram L.410. 6-volt: Marconi or Osram L.610.

Output.—2-volt: Mullard PM.252—a triode that will give greater output than the corresponding 2-volt pentode, Marconi or Osram P.240 with a bias of 24 volts, Mazda P.240. 4-volt: Mullard PM.24. 6-volt: Mazda P.625B.

(A specimen receiver is available for inspection at the Editorial Offices, 116, Fleet Street, London, E.C.4.)

¹ Burndepth Ethovernier No. 1151 fitted to set available for inspection.

² As, for instance, the "Blue Spot."

³ Carrington or Loek.

⁴ "The Band Pass Four," by W. T. Cocking, *The Wireless World*, June 25th and July 2nd, 1930.

Musical Oscillator

THE MARTENOT INSTRUMENT

By R. RAVEN-HART.



A New Application of the Valve Oscillator and Amplifier.

AMONG the more or less musical instruments presented recently which use valve oscillators perhaps the most fully developed is the Martenot, named after the inventor. Like practically all the modern "wireless-music" instruments, it uses the heterodyne note produced between two oscillators, and not the principle of fixed oscillating circuits.

From the circuit diagram it will be seen that S_2 , C_2 constitutes one such circuit, and L_2 with its associated condensers another; of these condensers, C_1 is the main condenser, C_3 is small and serves merely to reduce the effect of C_4 and C_5 , the former being the principal tuning condenser (adjusted at the factory) and the latter a small variable one accessible to the performer and serving to compensate for small detuning effects due to variations of plate and filament voltages.

The variation of the circuit S_2 , C_2 is not carried out directly, but through the closely coupled circuit containing S_1 . In parallel with this coil is a variable condenser, composed essentially of a conducting bar B and a moving metal cable C parallel to and close to it. One end of this cable is coiled on half

the double drum D , the other attached to a cord E , of which the other end is in turn coiled round the other half of the drum. It will be seen that as the finger-piece F attached to the cord is moved to left or right so more or less of the cable will be unrolled from the drum and simultaneously less or more of the cord, thus varying the capacity between cable and bar. A scale below F gives an indication of the amount of capacity in use, and hence of the beat-note produced. In the actual instrument this scale takes the form of a dummy keyboard.

It must, however, be emphasised that, despite the existence of this "keyboard," the instrument is in no sense tempered; that is to say, a theoretically infinite number of notes can be produced between any two notes of a piano. Thus half, quarter, eighth tones, and so on, are produced by placing the finger-piece in intermediate positions relative to the dummy keys instead of centrally over a given key.

The remainder of the circuit is fairly obvious. The variable resistance shown in the anode circuit of the last two valves is



Attached to the cord over the dummy keyboard is the finger piece. Tone and volume are regulated by the controls under the left hand.

ALMOST every sound producing device has been applied to some form of musical instrument. Thus the most modern adjustable sound emitter, the audio-frequency beat oscillator, forms the basis of a new instrument capable of giving musical notes unlimited range of pitch and perfectly graduated in volume.

The making up of apparatus to produce "wireless music" is being pursued and is arousing the interest of the wireless amateur. This description of the Martenot instrument is particularly complete in that it includes details of the circuit.

operated by a key, normally actuated by the left hand (the right hand controlling the pitch); the degree to which this key is depressed controls the amount of resistance left in circuit and, therefore, the force of sound produced. This key can be seen in the illustration in the form of a block of wood on the small drawer. It will be obvious that its operation in conjunction with the finger-piece allows of legato, detached, or staccato playing; a great advance on the earlier Theremin instrument, in which only legato effects were possible. As the resistance is tapered a very delicate "attack" is produced; but an alternative attack is available, giving results comparable to the trumpet or saxophone, by means of a switch connected in parallel with the resistance, which therefore cuts in full plate voltage when depressed rather than

building it up gradually. There is a second method of playing, more difficult but considerably showier and sometimes preferred by performers. In this case the dummy keyboard is not used, the end of a cord being attached to the right hand and the amount of cable arranged to regulate the pitch pulled out from the drum so that the control results from the distance of the hand from the instrument.

The musical value of the instrument may perhaps be disputable, particularly as a solo performer; as a member of the orchestra it has, however, great possibilities, giving the continued tone and practically unlimited range of pitch of the organ, together with a perfectly graduated range of volume, from practically inaudible to literally deafening, and producing glissandos and vibratos that are impossible on any other instrument.

The natural timbre of the instrument is very pure, being probably almost without harmonics; but these can be added at will by means of four "stops" (in the organ sense of the word) giving sixteen timbres in all. Three of these act by switching in filter circuits which absorb certain of the harmonics produced by the oscillators, so that the output is rich in partials, up to the twelfth, but these are removed at will. The fourth "stop," which is a two-way key-switch, when in one position renders the "attack" as produced by the tapered resistance even more delicate by connecting a filter circuit so as to absorb the transients, while in the other position it leaves these present; there are thus three grades of "attack" possible—resistance-operated and filtered, resistance-operated without filter, and switch-operated. It is perhaps desirable to add that this statement was supplied by the inventor himself. A fifth "stop" permits of pleasant echo effects, by switching from the normal loud speaker to another one suitably located.

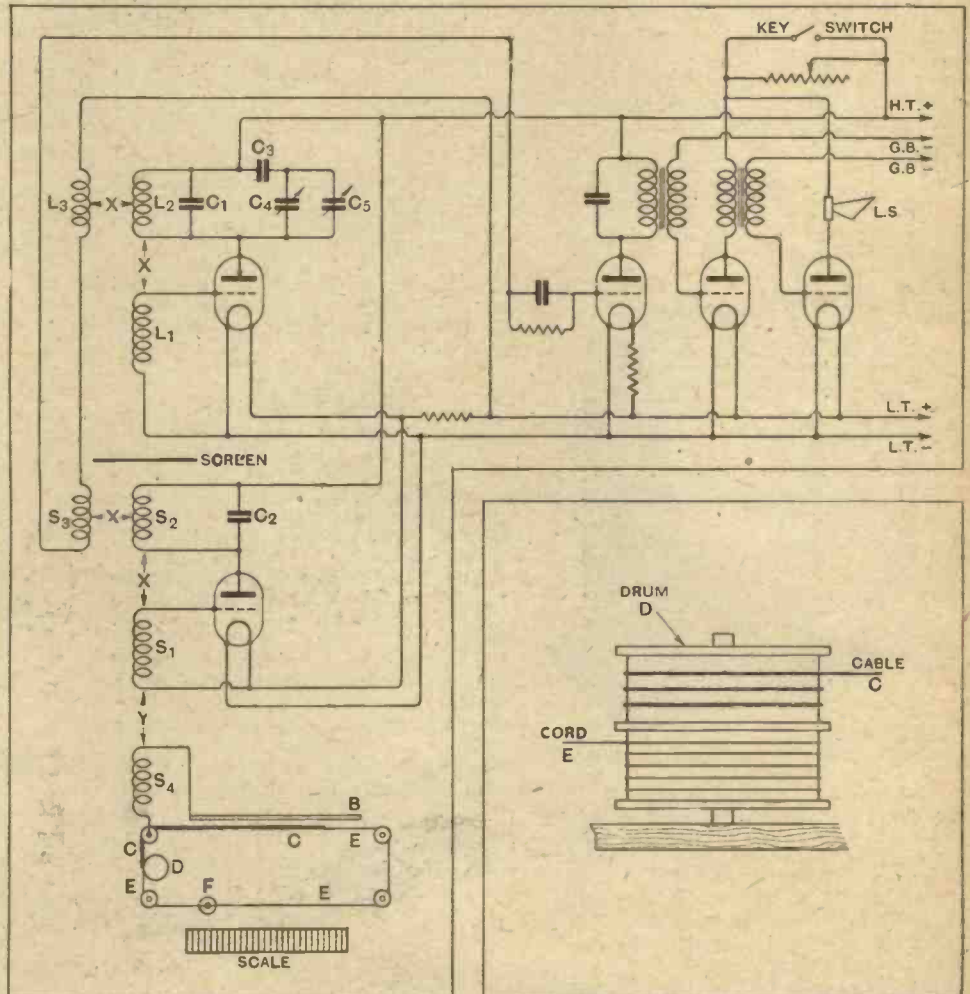

The circuit is that of a beat note oscillator controlled by a change of capacity in a coupled circuit.

WIRELESS WORLD

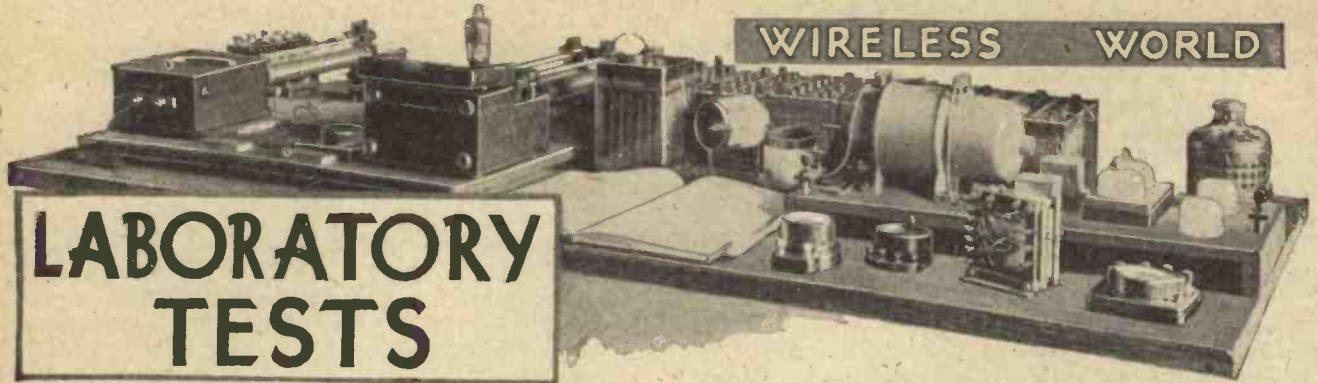

LABORATORY TESTS

A Review of Manufacturers' Recent Products.

"ATLAS" AUDIO-FREQUENCY COUPLER. Model A.F.1.

This device has been designed for low-frequency intervalve coupling, and consists of a resistance, a condenser, and a tapped choke arranged as depicted in the theoretical diagram given here-with. Regarded from one point of view, it may be considered to function as an auto-transformer shunt fed through the condenser with the steady anode current deflected through the resistance. This arrangement is often adopted when high permeability alloy is used in the core of the L.F. transformers.

The nature of the components adopted in this case do not indicate that it is for this reason that the arrangement is favoured. The anode resistance, in the model A.F.1, is of the composition type

drop need be expected. Used in this manner the coupler will afford a greater amplification, owing to the step-up auto-transformer, than would the familiar resistance-capacity coupling usually adopted in such cases.

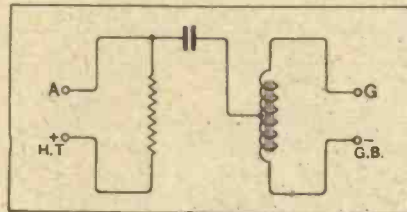

A resistance, a condenser, and a tapped choke arranged as depicted here are used in Clarke's "Atlas" L.F. coupler.

The makers are Messrs. H. Clarke and Co. (Manchester), Ltd., Atlas Works, Old Trafford, Manchester, and the price is £1 10s.

o o o o

TEST-O-LITE.

This tester, which takes up very little more pocket space than a fountain pen, affords a ready means of determining whether the electric supply is D.C. or A.C. When connected across an A.C. supply of between 110 volts and 550 volts, the two short wires in the neon tube glow brightly. In the case of D.C., only one wire glows, this being the continuation of the prong which will be in contact with the negative lead.

It is, therefore, a useful indicator of continuity in the case of A.C., and a polarity tester in the case of D.C. circuits. The neon tube is housed in a well-insulated bakelite cover, and the two contact prods, which are flexible, are protected by thick rubber sleeves.

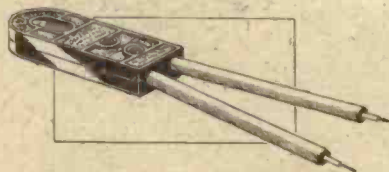

"Test-o-lite" A.C. continuity and D.C. polarity tester.

The "Test-o-lite" is obtainable from the Kothermel Corporation, Ltd., 24, 26, Maddox Street, London, W.1, and the price is 8s. 6d.

o o o o

MAGNUM NEUTRALISING CONDENSER.

A redesigned version of the magnum neutralising condenser is now available. In its present form the supporting plate for the top bearing is mounted on three pillars. The terminals are placed more conveniently than hitherto. The new support minimises the risk of the vanes short-circuiting.

The measured maximum capacity of sample tested was 31.5 micromicrofarads, and the minimum value 2 micromicrofarads. In addition to its allotted function



Clarke's "Atlas" low-frequency coupler, Type A.F.1.

and has a nominal value of 250,000 ohms, which value necessitates some consideration as to the type of valve to precede the coupler. A steady anode current of 1 mA. will lead to 250 volts being absorbed by the resistance.

The high order of resistance would prove advantageous if the device was to follow an anode-bend detector, and since the steady anode current will be exceedingly small, no serious voltage-

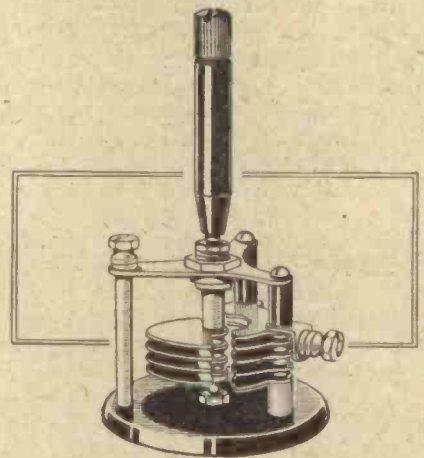

Redesigned Magnum neutralising condenser with a three-pillar support for the moving vanes.

as a neutralising condenser this model could be used as a "trimmer" across one or more large variable condensers in a ganged assembly. The long handle enables the unit to be mounted on the baseboard and adjusted without hand capacity causing any troublesome effects.

The makers are Messrs. Burne-Jones and Co., Ltd., 296, Borough High Street, London, S.E.1, and the price is 5s.

**R.K. PERMANENT MAGNET
LOUD SPEAKER.**

The B.T.H. Senior R.K. moving-coil loud speaker has already established itself in the front rank of sound reproducers. It is now available with a permanent magnet field for those who are unable to provide the necessary current from supply mains.

The 10in. corrugated diaphragm and 15-ohm speech coil and the method of suspension are exactly as in the models designed for mains field excitation, and damping rings are provided in the air gap to even up the frequency response. The massive permanent magnet is of the pot type and produces a flux density in the gap of 8,500 to 9,000 lines per square centimetre. An output transformer is, of course, necessary on account of the low-impedance speech-coil.

The acoustic characteristic is similar to that of the Senior R.K. The high-frequency response up to 6,000 cycles (the

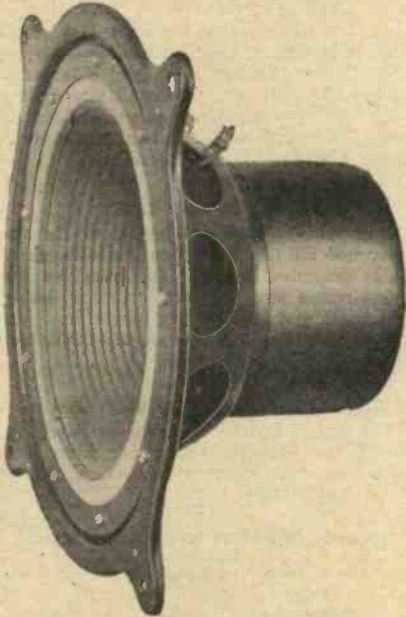

The new R.K. permanent magnet moving coil loud speaker.

highest frequency tested) is excellent, and the low frequencies are well represented without any undue tendency to booming. The unit is sensitive and will handle considerable power. It should prove useful in equipping outdoor public address systems, as the necessity of running power lines for field current is obviated. For home use a special cabinet has been designed by Messrs W. and T. Lock, Ltd., of Bath.

The price of the unit is £6 15s., and the distributors are The Edison Swan Electric Co., Ltd., 1a, Newman St., London, W.1.

o o o o

**SIEMENS "FULL-O'-POWER"
H.T. BATTERY.**

The high tension current taken by an average four-valve receiver fitted with modern valves and incorporating a good power stage is of the order of 18 to 20

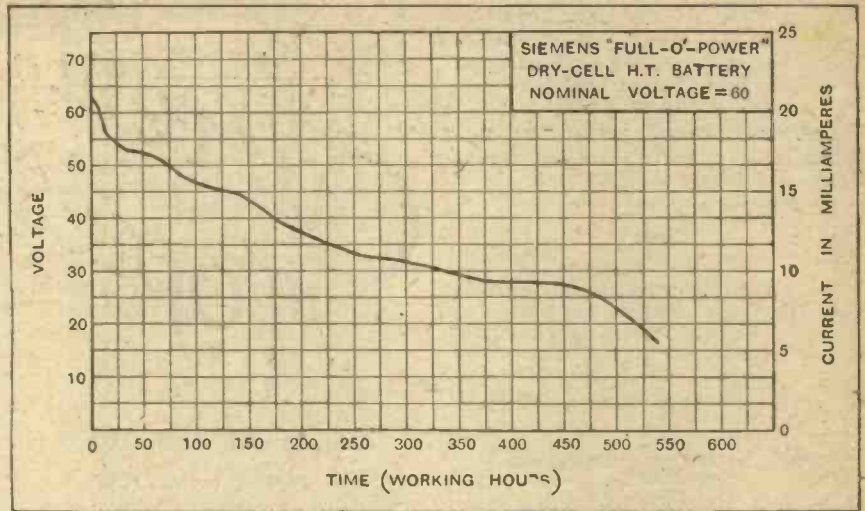

Discharge curve of the Siemens "Full-o'-Power" H.T. Battery.

milliamperes, which value has been regarded hitherto as well above the economical discharge rate of the ordinary medium-priced dry-cell batteries. The new "Full-o'-Power" battery, introduced recently by Messrs. Siemens Bros. and Co., Ltd., Woolwich, London, S.E.18, would seem to dispel this contention, since a discharge at the rate of 20 mA. is within its capacity to deliver, and at the same time afford a reasonable number of working hours. The price is 13s. 6d.

The size of the 60-volt battery is 11½ x 7½ in. x 3½ in., and intermediate voltage tappings are provided at 15, 30 and 45 volts. The sockets are arranged in line along one of the edges on the top, being very conveniently placed. A sample battery was subjected to our usual test, consisting of periods of discharge interspersed with equal periods for rest and recuperation. In the discharge curve given here the rest periods have been omitted for convenience.

The initial current was set at a little over 20 mA. After the first few hours, during which a rapid fall in voltage

gradual. It continued in this manner until a marked cut-off was reached after the battery had been on discharge for 450 working hours. This, however, is a little beyond the really useful life of the battery, which, if taken to the stage where the voltage per cell is down to 0.75, may be regarded as 330 hours. Assuming four hours working per day, the battery would have a life of about three months.

The more discriminating listener prefers to accept the useful life of his batteries as up to the point where the voltage per cell drops to 0.9, and in these cases 215 hours of work may be reasonably expected.

o o o o

TRADE NOTES.

Dual Motors, Ltd., 85-86, New Bond Street, London, W.1, announce that they have entered into an agreement with Kolster-Brandes, Ltd., Sidcup, Kent, for the manufacture, sale and service of the various types of Dual gramophone motors. A sales and service department has been opened at Kolster-Brandes' London premises, 163, Great Portland Street, London, W.1, to which address all orders and enquiries should be sent.

o o o o

Change of Address.

Radio Instruments, Ltd., 12, Hyde Street, New Oxford Street, London, W.C.1, announce that on June 21st, 1930, the whole of their business was transferred to new premises, including works, offices and showrooms, in Purley Way, Croydon, Surrey, to which address all correspondence should be sent.

The telephone number is Thornton Heath 3211 (3 lines), and the telegraphic address "Instradio, Croydon."

o o o o

Owing to extension of business, Detex, Ltd. (late Detex Distributors, Ltd., 125-129, Rosebery Avenue, London, E.C.1), have acquired more commodious premises at 161, Vauxhall Bridge Road, London, S.W.1. The telephone number is Victoria 1303 (6 lines).



Siemens "Full-o'-Power" dry-cell H.T. battery.

occurred, the current through the loading resistance steadied considerably, and from this period onwards the decline was more

HAVE YOU HEARD CALCUTTA ?

We understand that the new short-wave transmitter at Calcutta is now testing on a wavelength of 25.36 metres.

o o o o

EUROPE'S BROADCASTING LEAGUE.

Budapest is to be the venue for the next meeting of the Union Internationale de Radiodiffusion, which will open on October 13th.

o o o o

AERIALS IN LOFTS.

Without giving a reason, the Lincoln City Housing Committee has forbidden the erection of wireless aerials in the lofts of houses on the Council estate. Asked for an explanation, the Mayor stated that the practice was not in the interests of the Corporation.

o o o o

PROMOTION FOR WIRELESS ENGINEER.

Mr. T. J. Monaghan, B.Sc., M.I.E.E., who has been responsible for the engineering side of broadcasting since its inception in the Irish Free State, has been appointed Engineer-in-Chief of the Saorstát Post Office. Mr. Monaghan is President of the Irish Centre of the Institution of Electrical Engineers.

o o o o

PARIS STATION OF 85 KW.

By the end of September it is expected that the new Radio-Paris station at Essarts-le-Roi, in the suburbs, will be testing with a power of 85 kilowatts in the aerial. The station is nearing completion. Our Paris correspondent reports that the engineers are exasperated by the official delay in granting a permit for the land line which will connect the transmitter with the studios in the rue François 1er.

o o o o

U.S. RADIO PATENT POOL.

Damages to the extent of £6,000,000 are being sought by the Grigsby-Grunow Radio Company of Chicago in a suit filed in Kansas City against the Radio Corporation of America, the General Electric Co., the Westinghouse Electric Manufacturing Co., and others.

The plaintiffs allege the existence of an illegal pool of patents in violation of the Sherman Anti-Trust Law, thus involving the Grigsby-Grunow Co. in the payment of unnecessary royalties for radio valves.

o o o o

SKIP DISTANCE.

The "skip" distance effect, which plays so great a part in short-wave work, has been the subject of interesting researches carried out by Dr. A. Hoyt Taylor, of the Radio Division of the U.S. Naval Research Laboratories in Washington. According to Dr. Taylor, the average skip distances for the north temperate zone for midday in summer are found to be 1,000, 600, 300, and 200 miles for wavelengths of 16, 21, 32, and 40 metres respectively. In winter the distances are greater, the average for the above wavelengths being 1,350, 730, 400, and 200 miles respectively. The distances are shortest at midday, increasing gradually until, at midnight, they may be two and a half times their noon value.

Current Topics

Events of the Week in Brief Review.

CAMPAIGN AGAINST BROADCAST ADVERTISEMENTS.

A resolution passed by the Hamburg International Theatre Congress calls for the rapid international regulation of broadcasting and for the exclusion from the microphone of all forms of trade publicity.

o o o o

RADIO HORTICULTURE.

"The sea serpent of the silly season is a fossil at last," writes our Paris correspondent, who reports that the French summer is being enlivened this year with graphic newspaper stories of Dr. Fritz Hildebrand, the wireless horticulturist. Dr. Hildebrand, it seems, applies radio oscillations to his tomato beds, and the obliging vegetables burst forth three months ahead of their natural date.



SMALLEST RECTIFIER. The Arcotron, a new type of mains valve for use in battery eliminators, recently produced by the Telefunken Company in Germany. It is screened externally by a metal covering.

POWER INCREASE AT EIFFEL TOWER ?

An unconfirmed report that the Eiffel Tower will shortly increase its power from 12 to 24 kilowatts is arousing interest among Paris listeners.

o o o o

SMALL ADVERTISEMENTS.

The approach of the August Bank Holiday necessitates slight alterations in our printing arrangements. The latest date on which small advertisements can be accepted for *The Wireless World* of August 6th is Wednesday July 30th.

o o o o

WIRELESS TO REPLACE CHAPLAINS ?

Whether the casual wards should have the services of a chaplain or be equipped with wireless sets was a question discussed at the last meeting of the Bradford City Council. No definite decision was arrived at.

o o o o

THREE PIRATES A DAY.

In the House of Commons last week Mr. Lees Smith, the Postmaster-General, stated that during the twelve months ended May 31st last the Post Office undertook 1,029 prosecutions against unlicensed users of wireless apparatus, convictions being obtained in 1,024 cases.

o o o o

THE CLOCK SET.

The mantel clock set has made its appearance on the American radio market. It is described as the ideal receiver for guest rooms and servants' quarters, being self-contained and easily portable. In appearance it resembles an old-fashioned clock for the mantelpiece.

o o o o

THE FOREIGN LISTENERS' FOUR.

The large-capacity condensers fitted in the D.C. Foreign Listeners' Four described in this and our last issue are of the Baugatz type.

o o o o

RADIO OPPORTUNITIES IN THE R.A.F.

Posts as wireless operator-mechanics are among those available to five hundred aircraft apprentices, between the ages of fifteen and seventeen, required by the Royal Air Force for entry into the Schools of Technical Training at Halton, Bucks, and at Cranwell, near Sleaford, Lincs. Full particulars can be obtained from the R.A.F. (Aircraft Apprentices' Depot), Gwydyr House, Whitehall, London, S.W.1.

o o o o

THE BERLIN SHOW.

Six newly constructed halls displaying the best of German radio apparatus will make up the Berlin Radio exhibition for 1930, to be held in the grounds surrounding the famous Radio Tower from August 22nd to 31st. Besides dealing with the work carried out by the German broadcasting authorities and the radio trade, the Exhibition will also devote space to the products of the gramophone industry.

The Radio Tower, which is 450 feet high, incorporates a modern restaurant from which visitors can survey the exhibition grounds from a height of 180 feet.

INSULATORS
TESTED



{2}
KERAMOT

A Good Loaded Ebonite.

By W. H. F. GRIFFITHS, F.Inst.P., A.M.I.E.E.

KERAMOT is the trade name¹ for a particularly good loaded ebonite. It has a distinctive reddish-brown colour which is imparted by one of the minerals used to harden it.

As has already been explained, the chief objection to the use of true ebonite is not electrical but mechanical—the softening at the higher temperatures and the distortion or “cold flow” which occurs in consequence of this. Everyone has seen the effect of cold flow in the loosening of the winding of an inductance from its former, or, perhaps, in the relative displacement of the fixed and moving plates of a variable air condenser which is mounted on ebonite. Yet another evidence of this distortion with heat is to be found in the sagging of an ebonite panel on the underside of which a heavy component is mounted. Bolts tightened on ebonite often become slack in tropical climates for the same reason.

In order to overcome this defect ebonite is loaded with minerals which, unfortunately, while hardening the material, also impair its dielectric properties. Some loaded ebonites are in this way rendered very imperfect electrically, their power-loss factors being so high that they can no longer be classed as ebonites. In Keramot the loading is such that, although the high temperature coefficient of expansion remains, a good, hard non-softening material results without sacrificing to any great extent the dielectric purity. Moreover, this loaded

ebonite can be turned, drilled and tooled in the same way as true ebonite, but is, perhaps, a little more severe on the tools. Like ebonite it may be polished and may be satisfactorily moulded if extreme intricacies of shape are avoided. A typical Keramot moulding is shown overleaf.

The much smaller percentage of rubber contained in Keramot is, of course, responsible for its freedom from “cold flow,” and in cases where even more freedom from plastic yield is desirable this percentage is still

further decreased and an entirely new material termed “composite insulating material” is formed. The electrical quality of composite is, however, much inferior to that of Keramot; in other words, the loading is purposely overdone.

The loading of ebonite naturally increases the specific gravity of the material, and Keramot will be found to be 40 per cent. heavier than pure ebonite.

Before giving, quantitatively, the dielectric quality of Keramot, another of its advantages should be given—its freedom from “tracking” and from “wear” when used for the mounting of switch studs or contacts.

The power-loss factor of Keramot is approximately 0.05, and upon reference to the chart of insulating materials (Fig. 1) will be seen to be twice as bad as

pure ebonite but still four times better than the best bakelite and seven or eight times better than some bakelites and badly loaded ebonites.

Some idea of the kind of power loss which is to be expected from the use of Keramot insulation in the construction of wireless apparatus may be given by

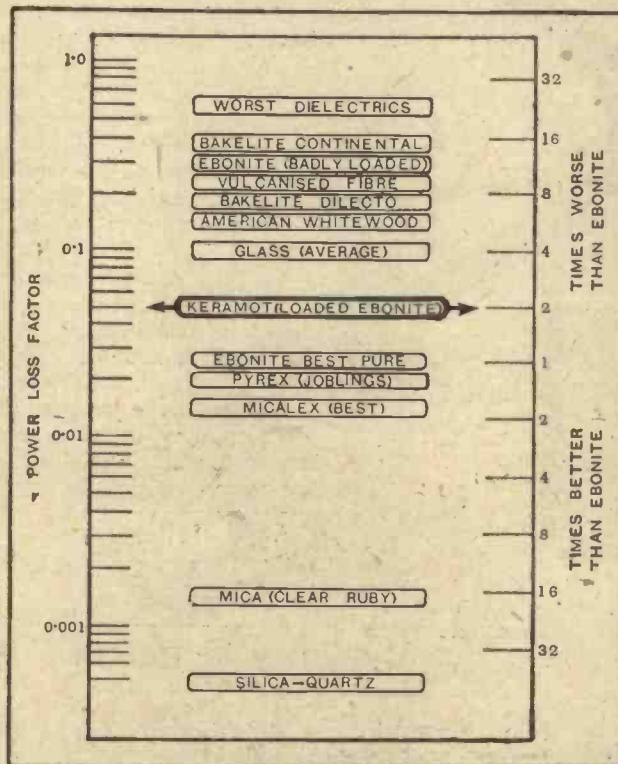
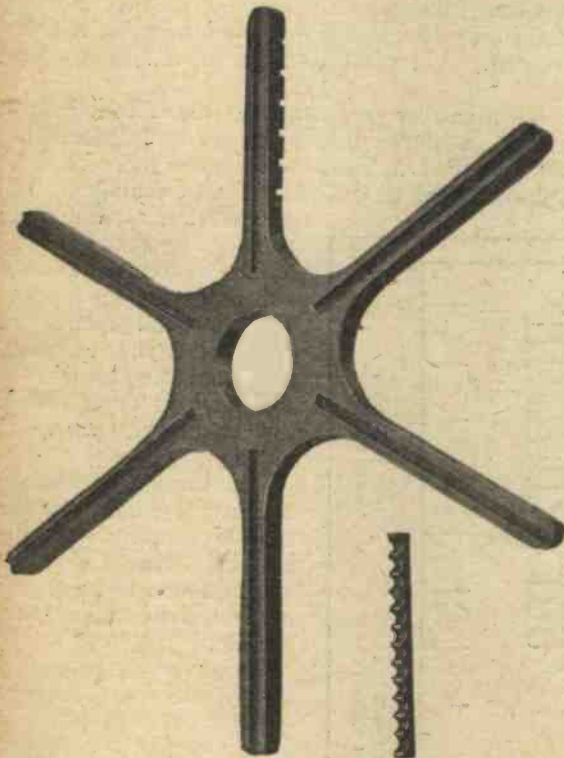

Fig. 1.—Chart showing relative power-loss factor of Keramot.

¹ Keramot is manufactured by Siemens Bros. & Co., Ltd., of Woolwich.

Insulators Tested—(2) Keramot.

consideration of the 250 $\mu\mu\text{F}$. air dielectric condenser of Fig. 2. If the capacity due to electric field through the insulators AA is 10 $\mu\mu\text{F}$., then if these insulators were of best pure ebonite, the equivalent resistance of the whole condenser at a wavelength of 300 metres would be 0.2 ohm. If the ebonite insulators are replaced by Keramot pieces of the same dimensions the effective resistance of the condenser will be increased approximately to 0.4 ohm. The effective resistance of the condenser could then again be reduced to the original 0.2 ohm by halving the electric field through the insulators either by doubling the length of the field (from the insulated plate system to the metal panel) or by halving the cross-sectional area of the insulators in a plane normal to this field.



A Keramot moulding.

A comparison between ebonite and Keramot is given in the following tabulation of approximate quantities:—

	Ebonite.	Keramot.
	Per cent.	Per cent.
Rubber	55	35
Sulphur content (total)	30	18
Sulphur content (free)	3	0.5
Acetone extract	5	2.4
Ash	0.75	28

As is usual with loaded ebonites the variation of power loss with frequency appears to be much less than in pure

ebonite and, moreover, it is certainly more constant with age. One possible reason for this power-loss constancy with age is, perhaps, that of non-deterioration by exposure to actinic light due to the fact that there is very little free sulphur in Keramot, as the accompanying tabulation shows.

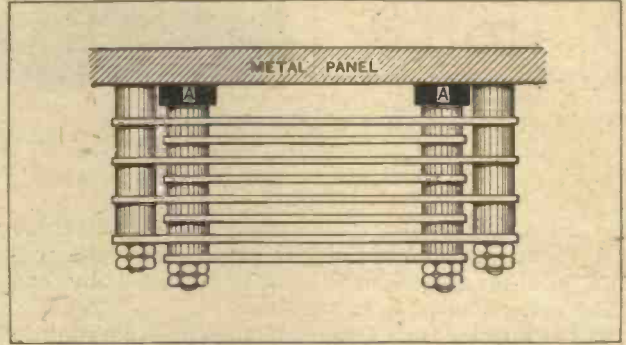

Fig. 2.—Standard air-dielectric condenser used throughout the series of tests.

In conclusion, the author would like to emphasise how important it is that an insulating material should have a definite cyclic temperature coefficient of expansion. Many insulators of low expansion have this property, but sometimes the necessity is felt for an insulating material of high thermal expansion which possesses this same property. The necessity for such a material occurs in the construction of composite insulating structures built to effect a geometrical thermal compensation of an electrical quantity.

An example of this is to be found in the Sullivan-Griffiths temperature-coefficientless inductance standards.²

For the construction of such a framework, ebonite would be quite useless because of its permanent distortion with temperature rise and the indefinite non-cyclic temperature coefficient of expansion consequent upon this. Keramot, on the other hand, has an expansion coefficient of the same required high order and is perfectly cyclic; it may, therefore, be used for this and many other purposes where a well-defined and predeterminable temperature coefficient of expansion is desirable.

² See *Experimental Wireless and The Wireless Ensigner*, Oct., 1929.

o o o

BOOKS RECEIVED.

Definitions and Formulae for Students (Electrical Installation Work), by F. Peake Sexton, A.R.C.S., A.M.I.E.E.—A useful little pocket book giving the definitions of practical electrical units and technical terms, with the symbols commonly employed; tables of cables and wire; current capacity of fuses; specific resistance of various metals; heating effects; current, efficiency and power factor of motors; illumination formulæ, and other useful data. Pp. 26. Published by Sir Isaac Pitman and Sons, Ltd., London, price 6d. net.

Autobiographical and Other Writings, by the late A. A. Campbell-Swinton, F.R.S. Published by Longmans, Green and Co., Ltd., London, price 10s. 6d. net.

BRIGHTER TELEVISION IMAGES.

Details of the New Telefunken Equipment.

IN the familiar method of television reception only a small fraction of the available light is used in the formation of the image. For instance, the cathode of the neon tube may measure about 2 sq. in., and, although emitting light from its entire surface, the amount of light used to build up the image is that which passes through a single small hole in the scanning disc representing less than 1/2,000th part of the available light. Consequently, the image possesses but poor illumination.

In place of the travelling point of light as produced by a scanning disc, an image of the entire cathode is used in the new Telefunken system, this being brought down to almost point size by focusing, the traversing effect being produced by

dot of considerable intensity. The lamp takes the place of the neon tube, the amount of light being controlled by a pair of Nicol prisms with a Kerr cell interposed between them. By this method a better control of light intensity is obtained than in the case of the neon tube, while a larger image can be formed, so that the use

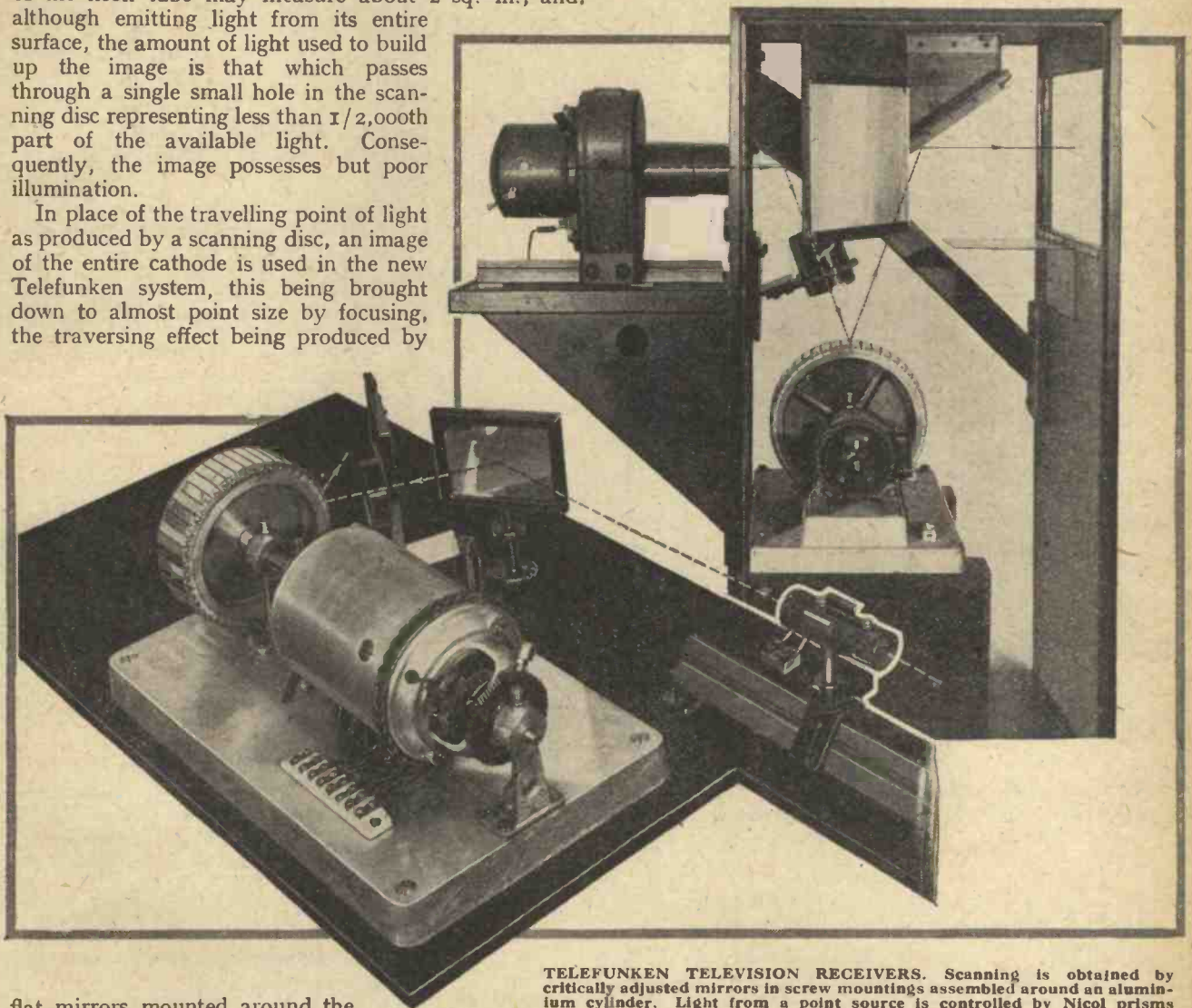

TELEFUNKEN TELEVISION RECEIVERS. Scanning is obtained by critically adjusted mirrors in screw mountings assembled around an aluminium cylinder. Light from a point source is controlled by Nicol prisms and Kerr cell.

flat mirrors mounted around the circumference of an aluminium wheel. To reduce the image of the cathode to a bright point of light a neon lamp with a much smaller cathode than is customary must be used, or otherwise the focusing lens would need to be placed near to the screen, and in consequence the traversing effect produced by the mirrors would become almost negligible. This difficulty is overcome by the use of a bright "point light" which can be focused on the screen as a white

of a magnifying lens is obviated. Being thrown on to a ground-glass screen, the image is visible to a bigger audience than is the restricted view of the neon lamp image behind the magnifying lens. Wind resistance and inertia are less in respect of the revolving mirrors than with the large-diameter scanning disc, so that synchronising is more readily controlled and curvature of traverse avoided.

WIRELESS
THEORY

SIMPLIFIED

By S. O. PEARSON,
B.Sc., A.M.I.E.E.

Part XXXVII.— Receiving Valves.

(Continued from page 47 of previous issue.)

IT is hardly necessary to state that the thermionic valve in its various forms constitutes the nucleus around which practically the whole of modern sending and receiving apparatus is built. In designing a receiver, one of the chief problems and the chief line of procedure is the adaptation of the various tuning circuits, output circuits, etc., to suit the characteristics of the "valves" used for amplifying and rectifying the received electrical variations picked up by the aerial circuit.

The term "valve" arose as the result of the properties, discovered in 1904 by Sir Ambrose Fleming, possessed by the combination of a hot filament surrounded by a metallic cylinder and enclosed in a bulb from which most of the air had been evacuated. On heating the filament by passing a current through it, it was found that a current of electricity could be passed between the metal cylinder and the filament when the former was maintained at a positive potential relatively to the filament. On the other hand, no current could be made to pass when the metal cylinder was made electrically negative relative to the filament. Thus, the device constitutes in the true sense an electrical non-return valve. Having two electrodes only, it is referred to as a "diode," and has been extensively employed for the rectification or detection of high-frequency oscillations in radio receivers. In this country the term "valve" has been retained, and is still applied in a general way to thermionic devices even when they are not used as valves at all in the true sense of the word.

Ionisation.

In the early experiments with the diode, the methods available for exhausting the air from the bulb were somewhat crude compared with present-day methods, and a certain amount of gas was retained in a rarefied state. Consequently, when the positive potential of the "anode" or "plate" surrounding the hot filament was raised sufficiently, a blue glow appeared within the bulb, this being due to the conversion of the gas into an "ionised" or conducting state. Current conducted through a rarefied gas in this manner is generally referred to as an ionic current, and this led to the name "thermionic valve" or "thermionic tube," the latter being the American equivalent term.

It was naturally imagined at the outset that the whole

of the current passing between the anode and filament was entirely ionic in nature—that is to say, that the whole of the current was being conducted by the ionised gas. But some time later, when methods were perfected for obtaining very high degrees of vacuum, it was definitely established that a current could be passed through the gap between the plate and the filament even when all traces of gas were removed from the bulb. This meant that a continuous stream of electrons could be drawn off from the hot filament and passed through the vacuum to the plate without any gas particles to convey them.

Direction of Electron Flow.

The current represented by the passage of free electrons across the space in the vacuum is referred to as an "electron current" as distinct from an ionic current conducted through a rarefied gas. The two main conditions for obtaining an electronic current through the vacuum are that the filament should have a sufficiently high temperature and that the anode is made electrically positive with respect to the filament or "cathode." The degree of temperature required depends upon the material of which the filament is composed. A pure tungsten filament, for instance, has to be run at a white heat (about 2,400° C.), whereas a thoriated tungsten filament requires a temperature of about 1,250° C. only, representing a straw-yellow glow.

It was explained in Part I of this series that a current of electricity is represented by a stream of electrons moving in one direction round a closed circuit and being driven by an electromotive force. In the case of a vacuum valve the stream has to pass across a gap where no conducting medium exists, and the electrons must therefore be shot out from the heated filament and collected by the anode, which has a positive potential with respect to the filament. Now according to the older ideas of electricity, current flows from a point of positive potential to one of relatively negative potential, except inside the battery or generator which supplies the driving force. It follows then, that the electrons representing the current actually move in the opposite direction to the conventional one in which the current is assumed to flow. This is simply due to an unfortunate choice in the early days when it was assumed that both kinds of electricity,

Wireless Theory Simplified.—

then arbitrarily designated positive and negative, moved simultaneously in opposite directions round the circuit. We now know that only one kind is mobile, and unfortunately this happens to be the one which was given the negative sign.

It must be remembered then, that when the direction of the current in a circuit is indicated by an arrow, the electrons themselves are moving in the opposite direction.

Electron Emission.

When a metal is heated to a high temperature its molecules are in a state of violent agitation, and when the temperature is high enough the metal actually evaporates. Each atom has large numbers of so-called free electrons associated with it, and it can be imagined that when the molecular agitation is very violent large numbers of these electrons will be thrown off from the molecules in much the same way that drops of water are thrown off from a wet brush when it is violently shaken.

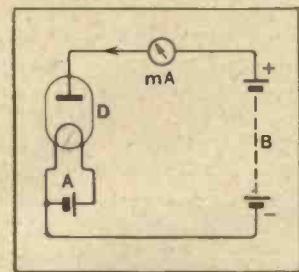

Fig. 1.—Simple two-electrode valve or diode. Although the current is assumed to flow from the anode to the filament inside the valve, the electrons representing this current move from the filament to the anode. The reason is explained in the text.

But when an electron leaves a molecule the latter becomes electrically positive because there are now not enough electrons to neutralise the positive charge in the molecule. The result is that there is a force tending to drag the escaped electron back again to the filament. By

placing a positively charged electrode (anode) in close proximity to the hot filament the attractive force exerted by it on the electrons which are emitted overcomes that tending to draw them back, and speeds them on their journey away from the filament until they reach the anode. It is essential that all gas or air should be removed from the bulb containing the filament and anode as gas molecules present in large numbers represent a considerable barrier to the passage of the electrons.

In Fig. 1 a simple diode is represented at D and consists of a metal filament and a metal plate enclosed in a bulb from which it will be assumed that all traces of gas have been removed so that the current passing through it is due entirely to electron emission. The filament is heated by current from a battery A and the anode is maintained at a definite positive potential with respect to the negative end of the filament by a second battery B connected as shown.

The electrons emitted from the filament and reaching the anode drive others already there round the external circuit through the battery B back to the filament to make good the loss there as a result of the emission. The stream of electrons, being continuous, represents a current round the closed circuit. It is unfortunate that we are obliged to indicate the direction of the current as

being from the anode to the cathode inside the bulb for the reasons already given.

The Space Charge.

When a body is electrically charged it possesses either an excess of (negative) electrons, being then negatively charged, or a deficit of electrons, when it is positively charged; and an electric field exists in the vicinity of a charged body. Now when the electrons are leaving the filament of the diode and passing to the anode there will be a large number of electrons in the space between the filament and plate, and these in themselves will constitute an electric charge in that space. This is referred to as the "space charge," and the electric field produced by it tends to drive back those electrons which are just leaving the filament because like charges repel each other. Thus unless the positive potential of the anode is sufficiently large to overcome the repelling effect of the space charge, all of the electrons emitted from the filament will not reach the anode; the majority of them may be driven back again to the filament from whence they came.

Maximum Emission.

When a graph is plotted showing the relation between the positive potential of the anode relative to the negative end of the filament and the current passed to the anode the curve takes the form shown by Fig. 2. The current represents the number of electrons passing per second.

For low values of anode potential the current is nearly proportional to the square of the voltage, but as the latter is raised a value is reached beyond which the current ceases to increase any farther. When this happens the space charge has been completely neutralised and the whole of the electrons emitted from the filament are attracted to the plate.

The maximum current or "saturation current" obtained in this way represents the total emission of electrons from the filament and is simply referred to as

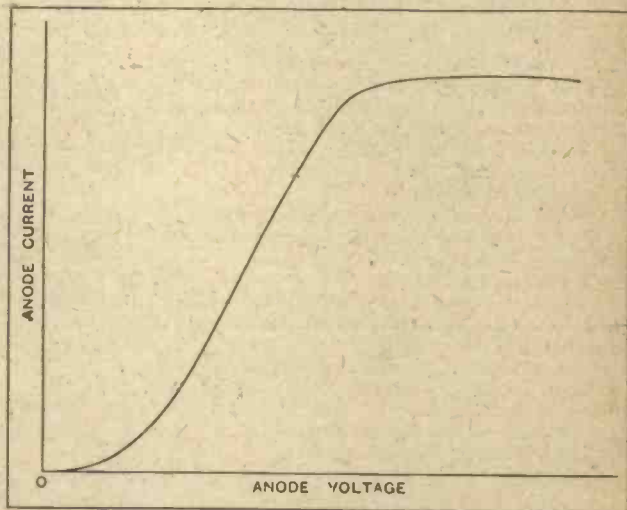

Fig. 2.—The curve shows approximately how the Anode current of a diode depends on the anode voltage. For a given two-electrode valve the maximum current or "emission" depends alone on the temperature of the filament.

Wireless Theory Simplified.—

the "emission" from the quantitative point of view. The emission depends on the temperature of the filament, its superficial area, and the elements of which it is composed. Tungsten can be easily drawn into a filament, but it must be run at a very high temperature to give reasonably good emission, with the result that a valve with a pure tungsten filament is rather uneconomical as regards filament current consumption, and has a comparatively short life.

Dull Emitting Filaments.

Thorium and the oxides of certain of the rarer metals have a high emission per square centimetre of surface at comparatively low temperatures, and in all modern valves the filament is treated so that its surface is coated with one or other of these elements, the name "dull emitter" having been applied to valves of this class.

The filament current is necessary solely for the pur-

pose of heating the filament or cathode to the required temperature. The necessary energy for temperature raising can be more cheaply and usually more conveniently obtained from alternating current supply mains; but as such alternating currents usually interfere with the normal functioning of ordinary valves with filaments, special valves are manufactured in which the electron-emitting cathode is indirectly heated; the heating current is passed through a special heating element in close proximity to the cathode but electrically insulated from it. In this type of valve the heating current may be alternating without any detrimental effect on the action of the valve. Valves with independently heated cathodes are called A.C. valves. A further advantage of the A.C. valve is that the cathode is at the same potential at all points on its surface, resulting in somewhat better characteristics for some purposes compared with the filament valve.

(To be continued.)

TRANSMITTERS' NOTES AND QUERIES.**Please Don't Do It!**

Correspondence from amateur transmitters is always warmly welcomed, but we would earnestly beg the younger members of the fraternity to write to us in English, French, German, Italian, Spanish, or American, but *not* in "Radiese." The "potent, grave, and reverend signior," whose pleasant task it is to compile these notes, though painfully conscious of his own literary shortcomings, retains an old-fashioned appreciation of the English language as the most expressive and expansible means of conveying thought clearly and concisely, and he detests the "nu spelin" and similar abominations. The W.P.B. (an abbreviation worthy of an honoured place in "Ham Language") yawns invitingly for correspondence, from perfect strangers, such as: "I send u ere a foto of mi Xmtr mi sigs reptd R4 fm N.Y., F.B. 73's O.M." (let it be stated at once that this is a promiscuous collection of orthographical crimes and not an extract from a genuine letter). The legitimate use of abbreviations in Morse transmission is, of course, recognised and appreciated, but the misuse in *written* correspondence arouses speculation whether it is merely an affected pose or is genuine illiterate ignorance. Economy of space justifies the use of similar abbreviations in "Small ads.," but we have never encountered the proprietress of a seaside boarding house who would extol her "comf. bd.-rs. mod." in this uncouth form when writing to a friend or prospective client. Now, having disburdened ourselves of this petulant and personal outburst, let us proceed to matters of more general interest.

○○○○

The Radio Amateur Call Book.

The June issue of the "Call Book" is now ready, and copies can be obtained from Mr. F. T. Carter, Flat A, Gleneagle

Mansions, Streatham, for 4s. 6d. post free for single copies, or 14s. 6d. for the four quarterly issues. The list of amateur transmitting stations in all parts of the world has, as usual, been carefully revised and brought up to date, and there is a very useful selection of short-wave commercial and official stations arranged in order of frequency from 2,020 kC. upwards, and a further list of the principal short-wave broadcasting stations. We would recommend readers to order their copies in good time from Mr. Carter, as the supply is limited and quickly becomes exhausted.

○○○○

Work on the 20-metre Waveband.

Mr. Robert Holmes, G6RH, has been busy reconstructing his station at Allerton, Liverpool, and has now worked with 27 countries, including Egypt (SU 8RS, Cairo), Morocco (CN 8MOP), European and Asiatic Russia, on 40 metres. He finds that the 20-metre band is "dead" after about 11.30 B.S.T.

○○○○

Amateur Telephony in U.S.A.

At the annual meeting of the Board of Directors of the American Amateur Relay League last May, the limitation of the use of telephony among amateur transmitters was carefully considered, and it was recommended that a licence for radio telephony should only be granted to operators having at least a year's experience in C.W. working and able to satisfy the authorities that they are sufficiently expert to work their stations without causing undue interference with others.

○○○○

Swiss Amateur Transmitter.

Mr. S. Schadler (HB9H), Frobelsstrasse, Wil, St. Gallen, is working on 42 metres telephony, and wishes to get into touch with British stations on this waveband.

NEW CALL-SIGNS.

- G 2IG R. H. Hammans, 110, Nelson Rd., Gillingham, Kent.
 G 2NM Gerald Marcuse, The Ranch, West Drive, Sonning-on-Thames, Beds. (Change of address). Telephony tests on 29.5 metres every Sunday at 18.30 B.S.T.
 G 2QS S. Ward, 32, Glendon Rd., S.W.16. (Change of address).
 G 5WL F. J. Rhodes, 318, Cauterbury St., Gillingham, Kent.
 G 6VB V. P. P. Blake, Aslockton, Nottingham.
 G 6XK A. C. Edwards, 62, Wellhead Lane, Perry Bar, Birmingham.
 G 2QI Douglas Briggs, Austin Friars, Newport, Mon., working on 163 metres generally between 9.0 and 9.45 a.m., and on 40 metres C.W. and telephony. Reports will be welcomed.

CEYLON.

- VS 7FP Old VS 7AH.
 VS 7TD E. Silva, Telegraph Dept., Colombo.

FRANCE.

- F 8DA G. Michaut, 70, rue de Peronne, Cambrai.
 F 8FI J. Deleplanque, 18, rue Varlet, St. Quentin, Aisne.
 F 8FW H. Kostka, St. Mihiel, Meuse.
 F 8HK Dubreuil, Loulay, Charente-Inférieure.
 F 8JL Cancelled.
 F 8OK A. Julien, 37, Faubourg d'Orléans et Banque de France, Pithiviers, Loiret.
 F 8PI P. Samuel, 1, rue Gilbert, Epinal.
 F 8PK M. Meffre, 14, rue Paradis, Marseille.
 F 8PM C. Vigouroux, 3, rue Barcelone, Villeurbanne, Rhone.

BELGIUM.

- ON 4TK (ex 4TE). Revd. O. Mathot, Missionnaire de Scheut, Yvoir.

BRAZIL.

- PY 9AD J. O. Silva, Rua Serraviti 92, Bello Horizonte.

GERMANY.

- D 4ADC D. A. S. D., Berlin-Schlachtensee.

CZECHO-SLOVAKIA.

- The following stations are now licensed, and cards need no longer be sent under cover.
 OK 1AA (ex AA2). Ing. M. Schaferling, Praha XII, Korunni 96.
 OK 1AB (ex OK1). P. Motycka, Praha-Branik, Kroska ul. 234.
 OK 1AF (ex 1AZ). J. Stetina, Praha-Nusle, Havlickova trida 160.
 OK 1AH (ex 1RV). A. Weirauch, Mestec Kralove, Namesti 0.
 OK 2AC (ex 2UN). MUC. Zdenek Neumann, Telc na Morave.
 OK 2AG (ex 2YD). L. Vydra, Telc na Morave 67/1.

RUSSIA.

- EU 5CW W. Osherow, Piatakowa 15/1, Kiev.

Paying for Empire Broadcasting.

Half the battle for Empire broadcasting has been won by virtue of the fact that everybody is now in favour of the project; but the money question is still unsettled.

I hear that the suggestion referred to in last week's *Wireless World*, viz., that the Treasury should be consulted in the matter, has been acted upon.

o o o o

Consulting the Treasury.

That the Treasury took unto itself approximately £342,000 out of the total amount collected last year from British listeners is a fact which has not escaped the notice of the Empire Broadcasting sub-committee appointed by the Colonial Conference. Consultations are taking place with the Treasury chiefs, and it would not surprise me if certain financial concessions were made for the cause of Imperial unity.

o o o o

Power Engineers and the Broadcast Listener.

One of the best news items for the average wireless enthusiast during the past week or two has been that the Second World Power Conference, recently assembled in Berlin, adopted a more or less sympathetic attitude towards the listener who is troubled with man-made static.

After the question of broadcasting had received a generous time allowance for discussion, many delegates agreed that electrical engineers should in future cater for the needs of broadcasting interests.

o o o o

Significant.

It is significant of the growing importance of broadcasting that recognition should come from a body of "dyed-in-the-wool" power men who think in tens of thousands of volts and imagine a millivolt to be some sort of insect.

o o o o

Offending Tramways.

The good intentions of world conferences are not always carried out in practice, and much has still to be done before British listeners have only the natural atmospheric to contend with.

To judge from the Savoy Hill post-bag, the tramways constitute the biggest source of interference in this country, though electric signs also have much to answer for.

o o o o

The Black List.

Twelve per cent. of the complaints in recent months have come from the London area, and the figures show that more crackles are generated south of the Thames than elsewhere. Static is least noticeable in West London.

Among industrial towns Birmingham produced more interference than any other, but letters of complaint have been received from 390 towns and villages.

o o o o

A Tale of a Talk.

Like the members of a certain community who earned a living by taking in each other's washing, many of the European broadcasting stations fill much of their programme time, with excerpts from the transmissions of their neighbours. It

Broadcast
Brevities

By Our Special Correspondent.

is not often, however, that an item from one station creates so much interest as to be repeated by another at a later date. This is the case with that singularly happy treasure-hunt story which Mr. Leslie McMichael broadcast from the British stations a few weeks ago.

o o o o

Fame Comes to Alboran.

Many listeners will remember that Mr. McMichael's adventure took him to the Spanish Island of Alboran in the eastern end of the Mediterranean. Apparently the magic name caught the ear of a Spanish broadcasting authority, for arrangements have now been made for an early repetition of the talk from all Spanish stations.

o o o o

Talkies Oust Organ and Orchestra.

Owing to the adoption of complete talking-film programmes by the Brixton Astoria, relays of orchestral and organ music from this cinema will not be heard by listeners after July 22nd.

Sir Thomas Beecham.

It would surprise many observers if the B.B.C. were to take the hint proffered last week by Sir Thomas Beecham to the effect that some scheme of collaboration could be arranged with the Imperial League of Opera whereby real opera could be regularly broadcast, the B.B.C. paying for the privilege.

Saddled with financial commitments in connection with the development of the Regional Scheme, the B.B.C. is in no mood to enter into any form of speculation, however inviting, for several years to come.

o o o o

Why We Buy Portables.

The other day the B.B.C. Technical Correspondence Department suggested to an elderly listener that an outside aerial would bring in better signals. The reply ran: "An outside aerial is impossible, as the children here will swing on it, being close to the school."

o o o o

Keeping the Loud Speaker Dry.

Critics who declare that too many songs of the sloppy, sentimental type are allowed on the ether should make a point of listening to "Sob Stuff," the latest of Gordon McConnel's programmes, to be heard on July 28th (National) and July 29th (Regional).

This programme has been specially prepared, I believe, as a "caution" to artistes of the sob-stuff school.

o o o o

"L.G." at the Microphone.

Mr. Lloyd George's speech at the National Eisteddfod, to be held this year at Llanelli, will be relayed in the National programme on August 7th.

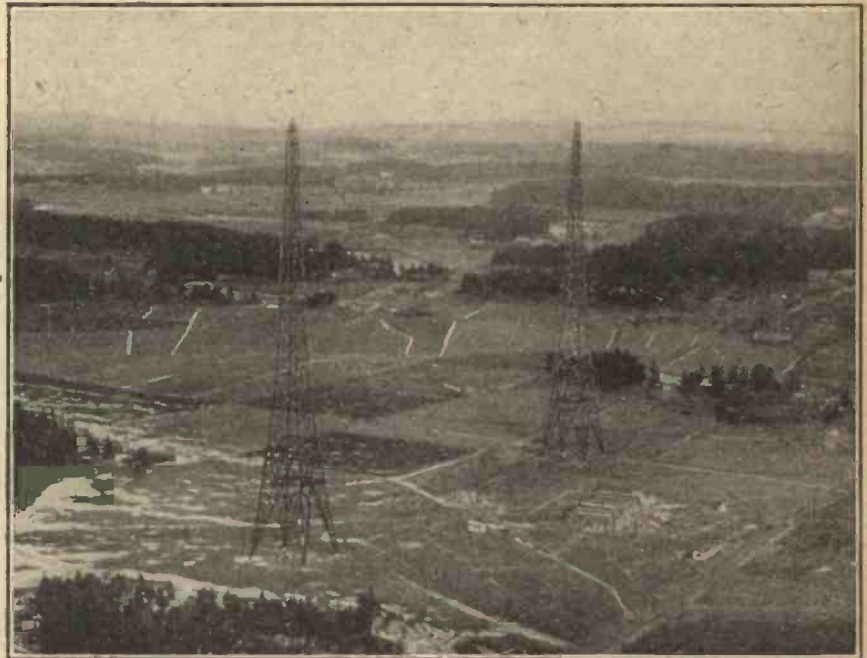
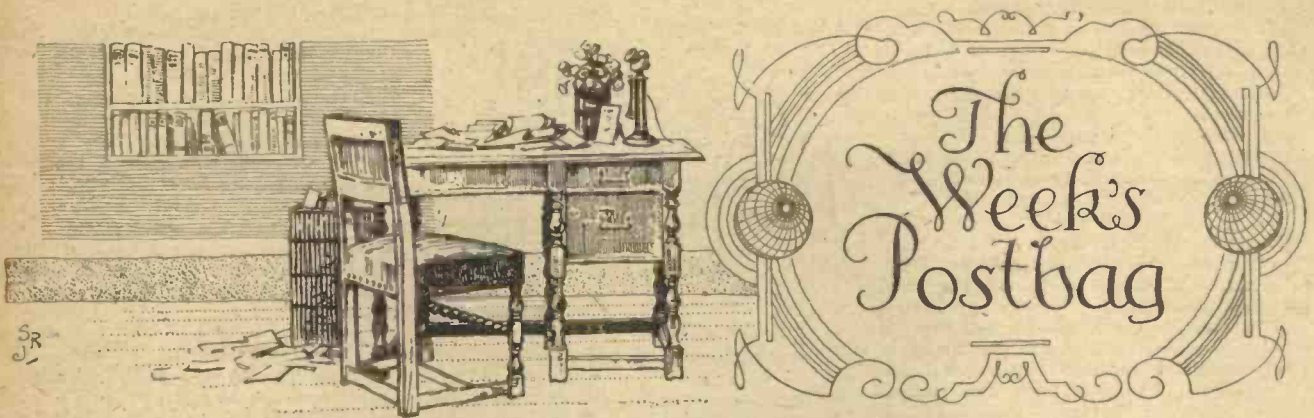

Photo.: Aerofilms, Ltd.

HIGH POWER FROM SWEDEN. An aerial view of the new 60-kilowatt broadcasting station at Spanga, near Stockholm, which operates on the low wavelength of 135 metres. The photograph was taken shortly before the completion of the station, which is now transmitting.



The Editor does not hold himself responsible for the opinions of his correspondents.

Correspondence should be addressed to the Editor, "The Wireless World," Dorset House, Tudor Street, E.C.4, and must be accompanied by the writer's name and address.

DUPLICATING 5XX.

Sir—With regard to your leading article in June 25th issue, which I read while on holiday in North Wales, may I take the opportunity of fully endorsing your sentiments in respect of the above station, and particularly from the portable users' point of view, as this station is very often the only one receivable with comfortable strength on such sets in these areas.

As an instance, I took my five-valve portable by car on our holidays at Rhyl, N. Wales, where I found 5XX the only station on which one could rely for entertainment, failing which the set might as well be left at home.

The need for an alternative on the long waves is also apparent with such receivers, when one is cut off the entertainment programme by talks, which not everyone wants particularly while on holiday.

Wallasey.

Sir,—Your suggestion in *The Wireless World* of June 25th that the B.B.C. should consider using another long-wave station filled me with alarm, consternation, and anger. I thought a storm would break upon your poor head and a real flood of protests would swamp you; but now I fear it has not happened, otherwise your correspondent would not have made the proud boast in your last issue that "Dignified excitement is observed at Savoy Hill over the suggestion in last week's *Wireless World* that 5XX should be duplicated."

However, I am sure you have done real harm to the future of broadcasting, as it is now almost impossible to tune in any foreign transmission except on the long wavelength, even with two screen-grid H.F. valves and aerial tuning; hence those who, like myself, have spent more money and time than we care to admit even to our friends, must give up what is an interesting hobby and a source of wealth to many small shopkeepers, not to mention the B.B.C.

I regret having to scrap so much expensive apparatus and to revert to a crystal set, or even discontinue the licence until such time as real progress is made in broadcasting, and would suggest that your valuable journal should try to help the muddlers at Savoy Hill by advocating that all countries should be limited to only two programmes on only two wavelengths, but as many stations as they can afford upon the selected wavelength. Failing agreement upon these lines, that listeners shall have the option of paying 15s. or even 20s. per annum for a licence, the whole of which money shall go to a station nominated by the listener, and a correct return of such licences to be declared by the Post Office.

Bedford.

JAS. A. HALL.

EMPIRE BROADCASTING.

Sir,—I am not sure whether you are aware of the enterprising manner in which our Dutch friends cater for short-wave listeners in India. They not only transmit every day of the week, except Tuesdays and Sundays, at a time which is very convenient for India, viz., 6.30 p.m. to 8.30 p.m., Indian standard time, but

they cable or post out in advance a fortnight's programme of their transmissions. These are sent to Messrs. Philips, who have their own organisation in India, and circularised to their agents in various parts of the country, while the Press also announce the times of transmission.

The station at Huizen was primarily erected for the Dutch East Indies, a country small in comparison to India, and as far as I am aware the inhabitants of the Dutch East Indies or their Government are not called upon to contribute towards its cost. I mention this because I have frequently seen it stated in letters to your paper and elsewhere, and also in one of your leading articles, that the B.B.C. cannot be expected to use their listeners' money for Empire or world broadcasting. I do not think anybody abroad would expect the B.B.C. to do this, but what wireless enthusiasts abroad really think is that, as the B.B.C. is the only institution who has the authority to broadcast, they—the B.B.C.—should secure an allotment from Government for the purpose of Empire or world broadcasting. Apart from the pleasure which English broadcasting would give to the Colonies and to the world in general, its chief advantage would be a larger demand for British wireless goods, which, of course, would benefit the manufacturers in the old country, just as Huizen and P.C.J. have helped to sell Philips' sets in this country and elsewhere. In India, at any rate, Philips are doing a splendid trade in their sets and other wireless goods, and their generous policy of exchanging faulty sets and valves free of charge, together with service, is a feature which British manufacturers would do well to emulate.

If the Government are unable to provide the money for an Empire station, why is it that the British manufacturers have not thought of contributing towards one? They probably have not given it any consideration, or, if so, they lack enterprise to proceed.

There are other countries who broadcast for the benefit of their colonies or the world at large; but they have not asked for outside financial help, so it seems strange to me that this question should have been raised.

India.

"TRAVELLER."

RECEPTION RECORD.

Sir,—I have just received my copy of *The Wireless World* for May 28th, 1930. I see in the "Correspondence" column that Mr. B. J. Silver has objected to the Alaskan record of reception of Brookmans Park, on what grounds it is not clear to make out.

If it is for reasons of distance, geographical or *via* the Heavside Layer, then I think Mr. Silver is mistaken, for Alaska is almost twice the distance of London-Lahore (going West from London to Alaska).

I can beat Mr. Silver's record, for I am stationed in Madras, and on several favourable nights I tune in London. I agree G5SW is a wash-out. The comparative distances of Lahore and Madras are as 4.3 : 5 as the plane flies. Mine is the McMichael superhet.

Bombay.

GOPALA RAO, D.B.

READERS' PROBLEMS



"The Wireless World" Supplies a Free-Service of Technical Information.

The Service is subject to the rules of the Department, which are printed on the next page; these must be strictly enforced, in the interest of readers themselves. A selection of queries of general interest is dealt with below, in some cases at greater length than would be possible in a letter.

A Simplified Circuit Diagram.

I am interested in the "Band Pass Four," but regret that I am unable completely to understand the theoretical circuit diagram given in Fig. 1 of your issue of June 25th. In particular, the arrangement of the capacity-coupled filters does not seem to coincide with that given in earlier articles dealing with this subject, although it is realised that the matter is complicated by the inclusion of waveband switching.

Perhaps you would be good enough to give me a simplified diagram, omitting non-essentials, of the complete receiver up to the detector; the L.F. portion of the circuit is quite clear to me.

T. F. S.

The circuit to which you refer is of necessity complicated by the provision of means for waveband changing; we think that its essential features will become clear to you after a consideration of the simplified diagram given in Fig. 1, from which we have omitted all switching, decoupling resistances, grid bias devices, etc.

Although the arrangement of the capacity-coupled filters is electrically

identical with those that have been already discussed, the relative positions of the components are slightly altered, in order that the need for insulating the rotors of the various tuning condensers may be avoided; this question of alternative positions for the coupling condenser was discussed in the "Readers' Problems" section of our issue of May 14th.

o o o o

Theory and Practice.

I am not quite clear as to whether it is usual, in drawing circuit diagrams, invariably to show metallic screening. With regard to diagrams given in "The Wireless World," can it always be assumed that this is unnecessary if it is not actually shown?

H. S. B.

No; this would be a dangerous assumption. Although there is no hard-and-fast rule on this matter, it is usual, in preparing diagrams of complete receivers, to include indication of screening, if it is necessary, but in sketches intended merely to illustrate a technical point, it is generally preferred to omit it, and thus avoid an unnecessary complication, which may tend to obscure the point at issue.

The whole question of screening has

received a good deal of attention of late in these pages, but if you are in doubt with regard to any specific published diagram, we should be pleased to give you definite information on this question.

o o o o

An Ambitious Battery Set.

I have a large battery of high-capacity H.T. accumulators, but no mains supply, and am thinking of building a set on the lines of the Band Pass Four, but modified for battery feed. Is this scheme practicable, and, if so, where should the bias cells for the H.F. valves be connected?

W. J. D.

It would not be difficult to modify this receiver for battery feed, but we fear that you will find its demands in the way of current to be rather extravagant, both as regards H.T. and L.T. supply.

Grid bias cells for the first and second H.F. valves respectively should be joined between the low-potential ends of the resistances R_1 and R_2 and the common cathode bus-bar.

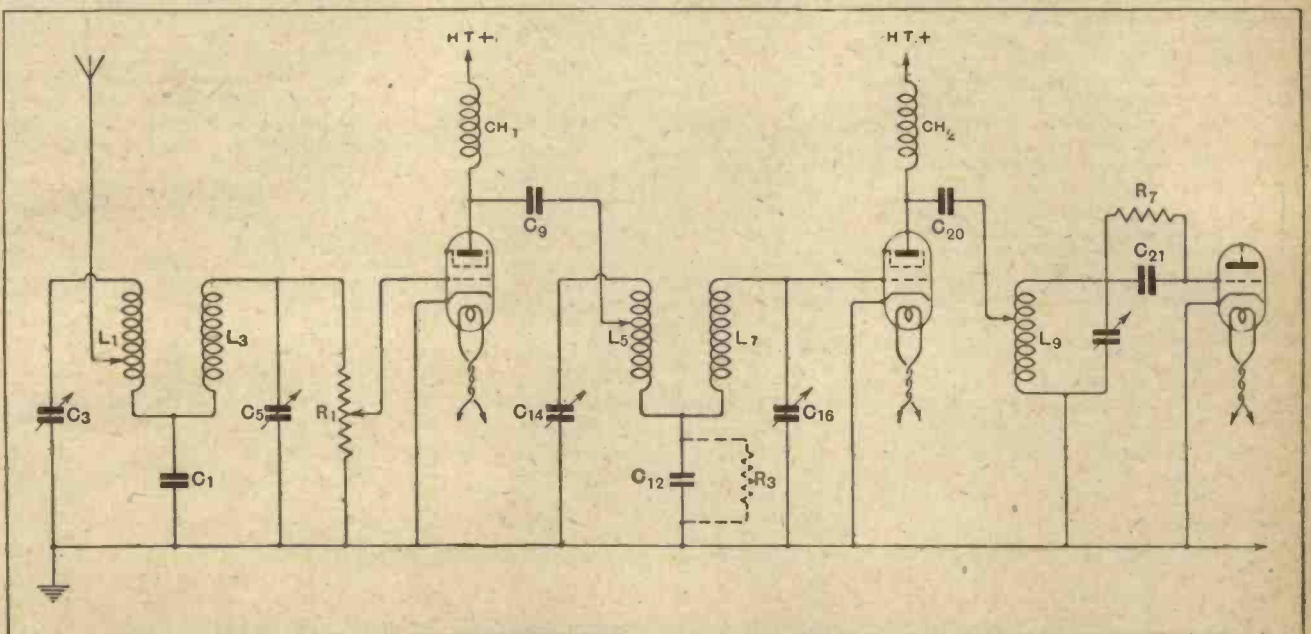

Fig. 1.—Simplified circuit diagram of H.F. stages and detector of the "Band Pass Four."

A.C. Current for Filament Heating.

I understand that when the current drawn from a power transformer is very much less than that for which it was designed there is inevitably a certain rise in voltage, the extent of this rise depending upon the regulation of the instrument. Is it likely that the winding of my present transformer, which is intended to deliver 1 amp. at 5 volts, will be capable of supplying the necessary current for an output valve rated at 6 volts 0.25 amp?

C. R. P.

It is almost certain that the secondary winding in question of the transformer will be adequate for this purpose. Even though the voltage under a light load may not rise quite to the figure at which the valve is rated, it is likely that it will be sufficient to ensure adequate emission.

Even though you may not have access to A.C. measuring instruments, it may be possible for you to check this point by temporarily heating the valve filament from an accumulator of the correct voltage, and noting whether anode current, as measured by a milliammeter, falls off appreciably when the battery is replaced by the transformer.

□□□□

Modified Output Connections.

In my present receiver I am using a push-pull output stage with choke feed to a moving coil loud speaker; this is entirely satisfactory, and, if possible, I should like to embody it in the "Band Pass Four," which I am about to construct.

If this modification is permissible, will you please give me a circuit diagram showing how it may be applied to the new receiver?

S. M.

A choke feed for the loud speaker could certainly be used in the "Band Pass Four" receiver, and we give in Fig. 2 a diagram showing the necessary modifications to the output stage. Incidentally, it seems certain that these connections will be exactly similar to those you are using at present.

RULES.

(1.) A query must be accompanied by a COUPON removed from the advertisement pages of the CURRENT ISSUE.

(2.) Only one question (which must deal with a single specific point) can be answered. Letters must be concisely worded and headed "Information Department."

(3.) Queries must be written on one side of the paper and diagrams drawn on a separate sheet. A self-addressed stamped envelope must be enclosed for postal reply.

(4.) Designs or circuit diagrams for complete receivers or eliminators cannot ordinarily be given; under present-day conditions justice cannot be done to questions of this kind in the course of a letter.

(5.) Practical wiring plans cannot be supplied or considered.

(6.) Designs for components such as I.F. chokes, power transformers, complex coil assemblies, etc., cannot be supplied.

(7.) Queries arising from the construction or operation of receivers must be confined to constructional sets described in "The Wireless World": to standard manufactured receivers; or to "Kit" sets that have been reviewed.

It may be that isolating condensers are inserted in the loud speaker leads in order to prevent D.C. currents passing through the windings, in the event of a short-circuit. If the loud speaker is mounted at some distance from the receiver, it may be an advantage to include these condensers (which should have a capacity of from 2 to 4 mfd. each), but it should be made quite clear that in an arrangement of this sort opposite ends of the choke are at the same D.C. potential, and that no direct current will flow through the loud speaker winding unless a short-circuit to earth be introduced.

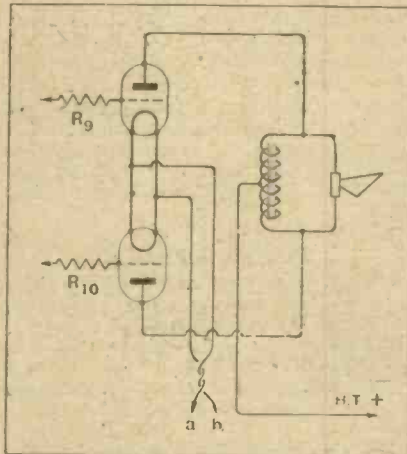

Fig. 2.—In place of the usual transformer: choke output for a push-pull amplifier.

High Voltage Essential.

I am thinking of making up a set on the lines of the "Power Pentode Two," but as considerable volume is not required, it is proposed to substitute a P.M.24 valve for the P.M.24A. which was specified. With this alteration, what reduction should be made in the H.T. voltage delivered by the power transformer?

R. W. M.

You appear to have overlooked the fact that the requirements of a receiver of this kind in the matter of H.T. voltage are largely determined by the needs of the power-grid detector; consequently, no appreciable reduction in voltage would be permissible.

To bring down the anode and screen voltages to the limits imposed for the pentode valve you intend to use, it will, of course, be necessary to make an appropriate increase in the values of the feed resistances.

□□□□

A Dangerous Modification.

Will you please show me how to adapt my existing four-valve receiver (of which I am sending you a circuit diagram) for use with indirectly heated A.C. valves? I believe that it should be possible to bring it up to date in this way without the need for making any very drastic alterations.

W. M. T.

Your circuit diagram shows an obsolete receiver with an unneutralised H.F.

stage coupled by the tuned anode method to a grid detector, which is followed by two transformer-coupled L.F. stages. A set of this sort was all very well in the days when valves were of much lower efficiency than at present, but its H.F. amplifier would certainly be lacking in stability if the alterations you propose were introduced. Similarly, low frequency instability would almost certainly result.

We feel sure that you would be well advised not to attempt to alter the receiver in this way: if you wish to bring it up to date, your best course would be completely to rebuild it, adopting a good modern circuit, for which as many as possible of your existing components would be used.

FOREIGN BROADCAST GUIDE.**STOCKHOLM**

(Sweden).

Geographical Position: 59° 17' N. 18° 3' E.
Approximate air line from London: 900 miles

Wavelength: 436 m. Frequency: 689 kc.
Power: 60 kW.

Time: * Central European (one hour in advance of G.M.T.).

* B.S.T. coincides with C.E.T.

Standard Daily Transmissions.

07.15-07.45 B.S.T. Physical exercises; 11.00 (Sun.) Church Service; 12.35 weather; 12.55 Time signal; 14.00 (Sun.) concert and Children's Hour; 18.00 (Sun.) relay of Sacred Service; 17.00 gramophone records, talks, etc.; 19.30 (Thur.) concert; 20.00 Time Signal and main evening programme; 21.15 news and weather; 21.40 concert, talk or language lesson.

Station usually closes down at about 22.30 except on Wednesdays, when dance music is broadcast to a later hour.

Male and female announcers. Call: *Stockholm-Motala* (pronounced: *Mott-Allah*).

No regular interval signal, but at times a small bell is struck between items (roughly 80 beats to minute).

Closing down words: *Godnatt, Godnatt Sov god* and occasionally the Swedish National Anthem is played.

Relays: Motala (1,348 m. 222.5 kc.); Boden (1,251 m. 239.8 kc.); Ostersed (770 m. 389 kc.); Hamar (570 m. 527 kc.); Sundsvall (542 m. 554 kc.); Uppsala (453 m. 662 kc.); Malmberget (436 m. 689 kc.); Goeteborg (322 m. 932 kc.); Falun (298.8 m. 1,004 kc.); Uddevalla, Varberg (283 m. 1,058 kc.); Trollhattan, Hudiksvall, Norrkoeping (270 m. 1,112 kc.); Hoerby (257 m. 1,166 kc.); Kalmar, Saffle, Eskilstuna, Kiruna (246 m. 1,220 kc.); Orebro (237 m. 1,265 kc.); Boras, Umea, Malmo, Helsingborg (231 m. 1,301 kc.); Karlstad, Ornskoldsvik (218 m. 1,373 kc.); Halmstad (216 m. 1,391 kc.); Gavle (204 m. 1,470 kc.); Kristinehamn (203 m. 1,480 kc.); Jonkoeping (202 m. 1,490 kc.) and Karlskrona (196m. 1,530 kc.).

WATCHING THE DIAPHRAGM VIBRATE

The Wireless World

AND RADIO REVIEW

The Paper for Every Wireless Amateur

Wednesday, July 23rd, 1930.

RECEIVED AUG 5 1930
J.F.F.
E.C.P.
P.11

4^D
1



TELSENS
L.F. TRANSFORMERS
Radio's Choice

Have acquired a world-wide reputation for Quality and Value. Built by Specialists in Transformer construction they have set a Quality of Performance above reproach. Your Set will work better with a Telsens Transformer - - - Fit one now!

Radiogram 12/6
Rattos 8-1 & 5-1
Radiogram 7-1
Ratio Price 17/6.

TELSENS ELECTRIC CO. LTD., Miller St. Birmingham.

ONLY 2/-

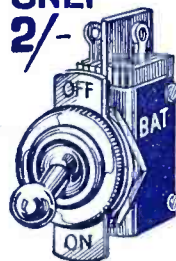

LYONS "B.A.T." 750-WATT "Q.M.B." POWER SWITCH

NOW DOWN TO 2/- (TYPE 730-Terminals-2/3)

Latest Model: easily breaks 3 Amps @ 250 V. "Q.M.B." Action: Indicating: Live Parts Insulated from Lever: One Hole Fixing: Nickel Finish. Small: Neat: Efficient: Guaranteed fully.

FREE

Send 1/4d. stamped addressed envelope for Art Booklet—12 illustrations—20 Circuits describing uses of this and our many other AC Snap Switches. Many problems solved. All types ready for delivery.

CLAUDE LYONS, LIMITED,
Head Office:—76 OLDHALL ST., LIVERPOOL.
LONDON:—40 BUCKINGHAM GATE, S.W.1.

TIP TOP QUALITY
ROCK BOTTOM PRICE

TUNGSRAM
ELECTRIC LAMP
WORKS (GT. BRITAIN) LTD.
Radio Dept., 72, Oxford Street,
London, W.1.
Factories in Austria, Czechoslovakia,
Hungary, Italy, Poland.



TUNGSRAM

BurTON

SELF-LOCATING VALVE HOLDER



1/- each

Pentode-Valve-Holders
1/6 each

Patent No. 318708

MANUFACTURED BY C. F. & H. BurTON

PROGRESS WORKS WALSALL, ENG.

Send your Goods by Air

Once you have experienced the enormous advantages of transporting freight by air you will never use any other method.

It means fewer breakages, because there is less handling. Lower insurance rates for all classes of goods—and quicker customs clearance.

Send them by

IMPERIAL AIRWAYS

THE ONLY BRITISH AIR LINE

In London, goods are collected on telephonic request, or may be handed in to any Freight Agent or to Airways House, Charles Street, Haymarket, S.W.1

Full particulars from any Freight Agent or direct from
IMPERIAL AIRWAYS LTD.

Airways House, Charles St.,
London, S.W.1

Telephone: Regent 7861
(Night & Day)
Telegrams: Impairlim, London



C.F.H. 42



Can you find what you want instantly in your stores, or have you to look through the lot before you come to what you want? Is it always "all blanks and no prizes"? Such procedure is neither pleasant nor profitable. Why continue with old-fashioned bins and pigeon-holes

when "Tiltracks" will keep your goods in full view, in compartments of the correct size for each component? Tiltracks combine maximum storage capacity in the least possible space with the most convenient form of goods handling. No other storage system can compare. **THERE ARE MANY STYLES OF TILTRACKS.**

THE "BENCHRACK" (Tiltrack Principle).

A real help for storing small parts such as Terminals, Nuts, Washers, Insulators, etc. Made to stand on the work bench, it enables all small parts needed for the job in progress to be stored where they are immediately to hand. All the trays are tilted so that the parts stored can be seen at a glance, and the front faces of the trays are rounded so that the smallest parts can be swept up the slope with the fingers of one hand. Each tray is provided with patent hinging partitions which can be moved quickly to make larger or smaller compartments. Being so accessible these racks greatly facilitate stocktaking. The Experimenter will do his jobs much quicker and with greater pleasure, and the Factory will save many pounds per year by installing this Benchrack.

30/- F.O.R.

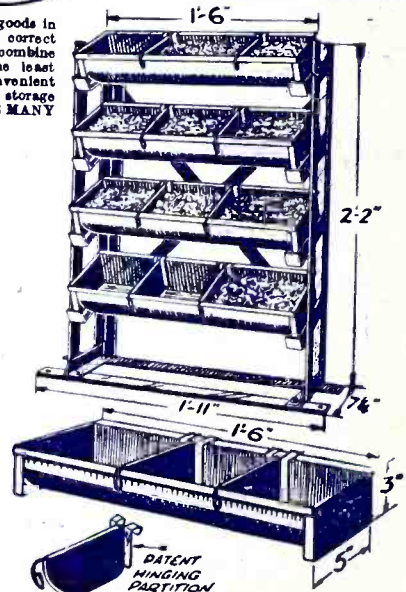

TILTRACK "JUNIOR"

Splendid for small components. Exceedingly popular in Private Garages, Households and Factories.

30/- Post Free

TILTRACK "TWEENIE"

Bigger than the "Junior." Very compact. Large storage capacity.

70/- F.O.R.



Particulars from Manufacturers & Patentee.—
BERTRAM THOMAS, Worsley Street, Hulme, MANCHESTER.
London Office & Showroom.—28, Victoria Street, S.W.1.

Mention of "The Wireless World," when writing to advertisers, will ensure prompt attention.

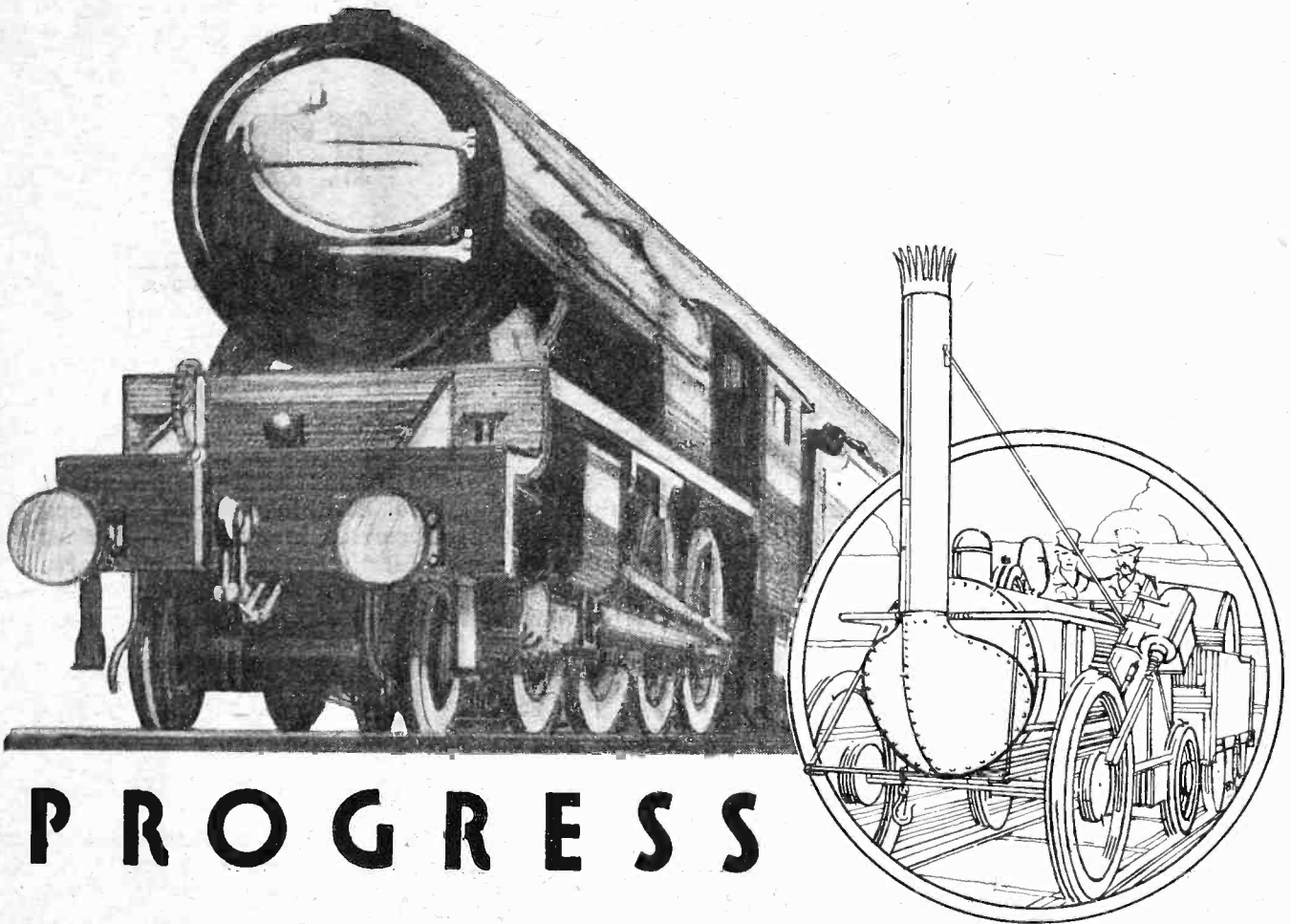

PROGRESS

The Pertrix battery achieves years of battery progress at one jump.

As the Pertrix battery contains

NO SAL-AMMONIAC

there is no corrosion in the cells.

Hence the Pertrix H.T. Battery gives 60% longer life than ordinary dry batteries. It does not crackle even after long use, and gives full value in a steady flow of power throughout its amazingly long life.

Pertrix is the only battery on the market with such a performance.

Pertrix batteries for flash lamps are also available. Write for leaflet "B," which will give you full particulars of all types.

What a life!



60% LONGER LIFE

PERTRIX

NON SAL-AMMONIAC

DRY BATTERY

PERTRIX, LTD., Britannia House, 233, Shaftesbury Avenue, London, W.C.2

PRICES.						
STANDARD.		DISCHARGE 12 MILLIAMPS.			GRID BIAS.	
Volts.	Size in inches.			s. d.	Volts.	s. d.
	L.	B.	H.			
80	5 7/8	6 1/2	3 1/4	8 0	9	1 6
100	8 1/4	6 1/2	3 1/4	13 0	12	2 3
120	10 1/8	6 1/2	3 1/4	15 6	15	2 9

ALL MAINS RADIO AT



ITS BEST!

PRICE:
A.C. or D.C.
£25

Generous Hire Purchase
terms can be arranged.

Dubilier all mains sets are the result of the specialised knowledge of Dubilier engineers combined with modern manufacturing methods to produce real instruments—not an assembly of odd components. All the latest practices have been incorporated in the design of Dubilier sets and they are unequalled by any other 3-valve set for quality, range and volume.

DUBILIER CONDENSER CO. (1925) Ltd.,
Ducon Works, Victoria Road, North Acton,
London, W.3.

DUBILIER

ALL ELECTRIC RADIO

Weston sets the world's standard



Model 528, Pocket Size
A.C. Tester

A small and reliable instrument essential to maintain accuracy and efficiency in voltage control. The sensitivity is remarkably high, 6 m.a. for 600 volts with self-contained resistance. The scale is very legible and the damping excellent. This instrument is capable of continuous service at full load.

Prices from
£3 . 10 . 0 to £4 . 15 . 0

WESTON
ELECTRICAL INSTRUMENT
CO., LTD.

15, Great Saffron Hill, London, E.C.1
A.1

Hear the new N.K. FARRAND INDUCTOR

LOUD SPEAKER

Moving Coil quality without
its drawbacks. £3 12 6

The latest eliminators and all-mains units
specially made for portables and built-in
sets from £2 10 0 to £6 0 0

The new Blue Spot units and chassis now
in stock. 66 R unit 35/-, chassis 15/-.
66 P unit 27/6, chassis 15/-.

A large selection of clockwork and elec-
tric gramophone motors for constructional
purposes.

B.T.H. microphones and transformers in
stock suitable for home or public address
work.

Microphone £6 0 0, transformers 15/-.

WILL DAY LTD.

19, LISLE STREET,
LEICESTER SQ., W.C.2

'Phone: Regent 0921-22.

The Vital Link—



H.T. Radio Accumulators

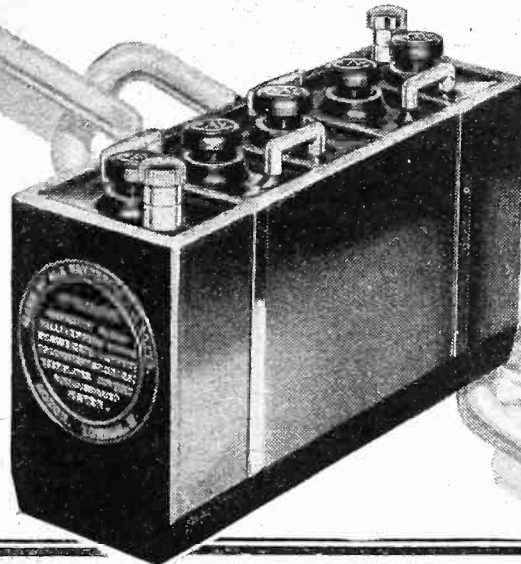
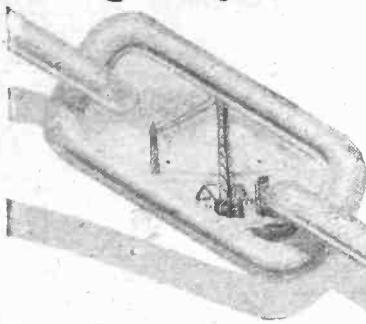

<i>Price of 10 volt units—</i>		
M.101	2,500 milliamps	5/-
M.103	5,000 milliamps	6/3
M.105	10,000 milliamps	12/-
<i>Price of 30-volt groups with trays—</i>		
M.301	2,500 milliamps	18/9
M.303	5,000 milliamps	23/3
M.305	10,000 milliamps	42/-

The inability of an H.T. Battery to provide smooth, unstinted current will mar the performance of the most perfect radio receiver.

No other form of H.T. current supply equals the C.A.V. H.T. Accumulator. The demands of the small set and the multi-valve set are satisfied with equal ease. Current is delivered smoothly, constantly, without a ripple or a crackle to disturb the perfection of the broadcast.

It costs a few pence for recharging three or four times a year, and because of its long life proves not only the most efficient, but also the cheapest form of H.T. current available.

Catalogue No 114 will gladly be forwarded upon application

CAVandervell & Co. Ltd.
ACTON, LONDON, W 3

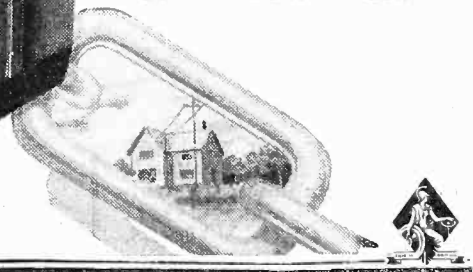

USE YOUR A.C. MAINS AND A WESTINGHOUSE RECTIFIER

TO GET THE BEST OUT OF YOUR SET IN THE EASIEST WAY



METAL RECTIFIERS have a higher efficiency than any other form of rectifier.

They have nothing to wear out—no fragile filaments—no chemical action—and therefore do not require periodical replacement.

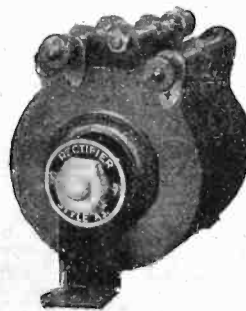

Type A3
D.C. Output 9 v. 1 amp.
23/6

Most of the leading manufacturers are incorporating the Westinghouse Metal Rectifier in their sets and eliminators.

There are units for all purposes — high tension, low tension, battery charging, grid bias, etc.

The Westinghouse Brake & Saxby Signal Co. Ltd.,
82, York Road, King's Cross, London, N.1.

Send a 2d. stamp for our 32-page Booklet "The All Metal Way, 1930," which gives circuits and full details.

WHEN BUYING VALVES— Remember

This !

If it's range you want you must have H.F. valves capable of great amplification with stability. MARCONI SCREEN GRID VALVES, by reason of advanced design and rigid construction, ensure the greatest useful amplification per stage. Put them in your set and hear stations you have never heard before! Here is the range — a type for every set.

FOR BATTERY OPERATED SETS

S.215 (2 volt)
recommended for S.G. Portables
S.410 (4 volt)

recommended for S.610 (6 volt)

FOR A.C. MAINS SETS

M.S.4 (Indirectly Heated)
S Point 8 (Directly Heated)

Marconi Experts produced the first British Screen Grid Valves. That lead is still maintained.



When the R100
was lost in fog
MARCONI VALVES
gave her position
through Wireless
Direction
Finders



MARCONI VALVES
are used by Imperial Airways—
The B. B. C. — Metropolitan
Police — Trinity House Lightships
and Beacon Stations—Croydon
Control Tower—etc., etc. They are
chosen for unflinching dependability.

MARCONI VALVES



Mention of "The Wireless World," when writing to advertisers, will ensure prompt attention.

The Wireless World

AND
RADIO REVIEW
(18th Year of Publication)

No. 569.

WEDNESDAY, JULY 23RD, 1930.

VOL. XXVII. No. 4.

Editor : HUGH S. POCOCK.
 Assistant Editor : F. H. HAYNES.
 Editorial Offices : 116-117, FLEET STREET, LONDON, E.C.4
 Editorial Telephone : City 9472 (5 lines).
 Advertising and Publishing Offices :
 DORSET HOUSE, TUDOR STREET, LONDON, E.C.4.
 Telephone : City 2347 (13 lines). Telegrams : "Ethaworld, Fleet, London."
 COVENTRY : Hertford Street.
 Telegrams : "Cyclist, Coventry." Telephone : 5210 Coventry.
 BIRMINGHAM : Guildhall Buildings, Navigation Street.
 Telegrams : "Autopress, Birmingham." Telephone : 2970 and 2971 Midland.
 MANCHESTER : 260, Deansgate.
 Telegrams : "Iliffe, Manchester." Telephone : 8970 City (4 lines).
 GLASGOW : 101, St. Vincent Street, C.2.
 Telegrams : "Iliffe, Glasgow." Telephone : Central 4857.
 PUBLISHED WEEKLY.
 Subscription Rates : Home, £1 1s. 8d. ; Canada, £1 1s. 8d. ;
 other countries abroad, £1 3s. 10d. per annum.
 Entered as Second Class Matter at New York, N.Y.
 As many of the circuits and apparatus described in these pages are covered by
 patents, readers are advised, before making use of them, to satisfy themselves
 that they would not be infringing patents.

CONTENTS OF THIS ISSUE.		PAGE
EDITORIAL		73
SOME APPLICATIONS OF ULTRA SHORT WAVES.	By DR. F. NOACK	74
PRACTICAL HINTS AND TIPS		77
THE PENTODE AND POWER OUTPUT.	By E. YEOMAN ROBINSON	79
LABORATORY TESTS ON NEW APPARATUS		82
CURRENT TOPICS		84
WATCHING THE DIAPHRAGM VIBRATE.	By G. F. DUTTON	85
BROADCAST RECEIVERS REVIEWED, R.I. "MADRIGAL MAINS FOUR"		87
WIRELESS THEORY SIMPLIFIED (CONTINUED).	By S. O. PEARSON	80
CORRESPONDENCE		91
BROADCAST BREVITIES		93
READERS' PROBLEMS		94

VALVE PRICE REDUCTION.

AS we go to press with this issue the welcome news reaches us that the British Radio Valve Manufacturers' Association has agreed upon an all-round reduction in the price of British receiving valves, this reduction to include all but a few of the newest types.

Readers will recollect that the last substantial price reduction in valves followed on a campaign conducted through *The Wireless World* in 1927. During the intervening period we have not felt that a further reduction could fairly be demanded, in view of the very great changes which have been taking place in valve technique, necessitating on the part of the valve manufacturers a large amount of experimental work which is extremely costly and unproductive until the ultimate design is finally decided upon. It is, therefore, the more gratifying to find that the present price reduction has come about sooner than we had expected.

We understand that the reduction dated from Friday,

the 18th, so that those readers who may have had occasion to buy valves during the last few days may already have experienced the satisfaction of paying approximately 2s. or 2s. 6d. less for their valves than they have been accustomed to pay in the past.

o o o o

MAN-MADE STATIC.

CORRESPONDENCE in this issue under the title of "Interference with the Reception of Radio," raises anew the question of control over sources of artificial interference which hampers radio reception. It is recognised that it is almost impossible to eliminate interference of this nature at the receiving end and, therefore, we are dependent upon those controlling the source of interference to effect a remedy.

When Parliament, in 1925, considered a short Bill relating to wireless telegraphy which was drafted with the idea of clarifying the position of authority of the Postmaster-General, we well remember that a clause included in the Bill, which would have given the Postmaster-General control over the radiation of electrical energy, provoked such an outcry that that clause was eventually dropped before the Bill became law. We recollect, too, that at that time we supported the objections to the inclusion of the clause because it was generally felt that the Postmaster-General's powers ought not to be extended to the control of electrical energy which might have nothing to do with the telegraphic or telephonic communication monopoly of the Post Office.

Progress in general electrification and the expansion of broadcasting in this country has served to bring home more forcibly than ever the necessity for some sort of control over what is fast becoming a nuisance, particularly in some less fortunate areas. The Postmaster-General apparently admits that he has "no statutory powers under which he could compel the owner of an electrical plant causing interference with wireless reception to remove the cause of the interference," since this statement is quoted from a letter from the Engineer-in-chief to Mr. James Nelson, who communicates to our correspondence columns in this issue.

We know that the B.B.C. is taking active steps in the spirit of co-operation and persuasion to endeavour to bring about a reduction of interference where this is due to avoidable causes, but if persuasion fails to have the desired effect, is it not time that some form of legislation should be introduced to control such causes of interference with reception now that broadcasting may be regarded as one of the common amenities of life?

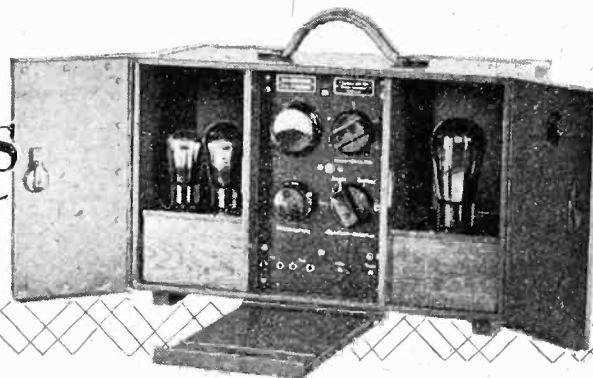
Some
ApplicationsUltra
Short Waves

Experiments in Transmission and Reception below 10 metres.

By DR. F. NOACK.

THE earliest investigations made in Germany into the practical application of the ultra-short waves (below 10 metres) were carried out by Professor Esau, of the University of Jena, whose work met with considerable success. His experiments were primarily directed towards determining the suitability of ordinary transmitting valves for ultra-short wave work, and towards finding a convenient mode of raising the power and of modulating for telephony. He paid some attention also to the problems of reception on these wavelengths, and to the range attainable, though in this latter connection he restricted himself to comparatively short distances.

Using Professor Esau's experiments as a starting point, Messrs. C. Lorenz, of Berlin, are engaged in a comprehensive series of experiments on the design of apparatus for making practical use of these ultra-short waves. Part of the work is being carried out with the assistance of Professor Esau, and part in conjunction with the Radio division of the German Aerial Research Institute (Professor Fassbender).

Several organisations are interested in the use of ultra-short waves. The chief of these, besides the aircraft companies, are the railways, the army, the navy, and, to a certain extent, the telegraph service.

Previous experiments have shown that the ultra-short waves behave much like light waves in their mode of propagation, in

that their radius of action only extends to the horizon. The range can therefore be increased if the transmitter or the receiver is raised high above the surface of the earth.

From the experiments already carried out it seemed likely that ultra-short waves, like light, follow the inverse square law, and it had been shown that they could be refracted like light. Further, obstacles of every kind appeared to produce shadows. To determine whether

these conclusions were really applicable to the propagation of the ultra-short waves, experiments were undertaken from an aeroplane. For this purpose the transmitting and receiving apparatus shown in the title illustration and Figs. 1 to 3 were used. The two parts were enclosed in water-tight boxes, which also contained the microphone amplifier for telephony and the receiving amplifier. The transmitter had a power of 1 to 2 watts in the aerial; the receiver was of the super-regenerative type with a two-stage low-frequency amplifier.

A Junkers aeroplane (cabin type) was used for the investigation. The transmitter was attached by springs to the outside of the body, while the receiver was entirely within the cabin, the high-frequency portion being fixed, again on springs, to the window. No aerial was used at any time.

For the first experiment the aeroplane was used only for transmission, reception being carried out on the ground. The range attainable with

Fig. 1.—(Right) High-frequency section of the 3-metre transmitter used for the research.

Fig. 2.—(Below) High-frequency section of the 3-metre receiver.

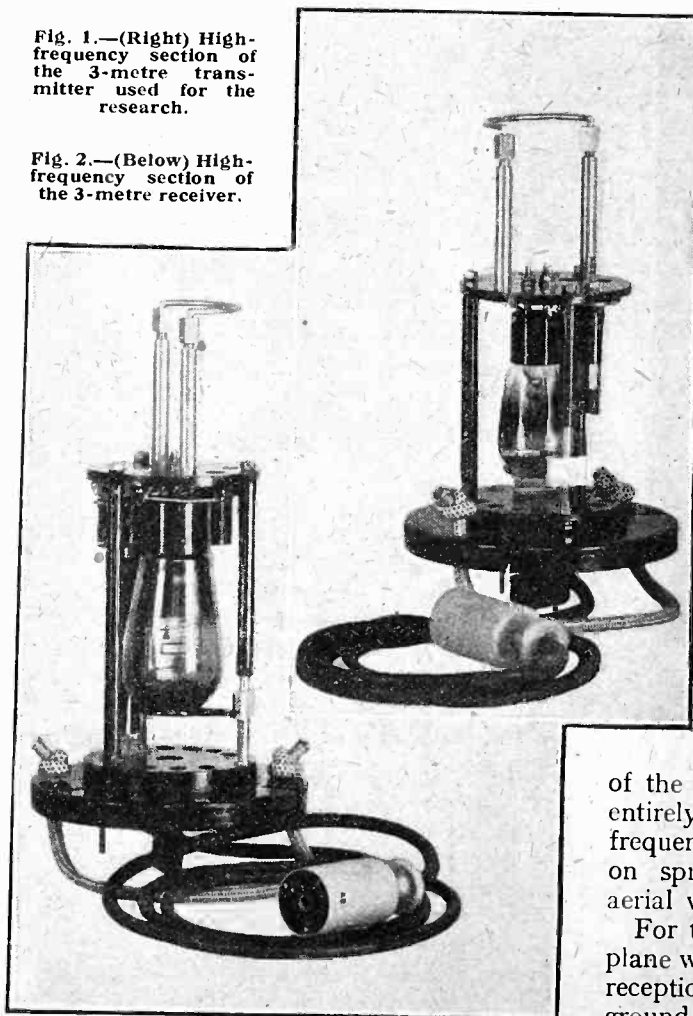

Some Applications of Ultra Short Waves.—

the aeroplane flying at a fixed height of 1,000 metres was determined, and it was found that the signal strength was R8 to R10 up to 30 km., but fell off rapidly after that distance, signals disappearing completely when the transmitter had flown to a distance of 50 km. from the receiver. At distances up to about 10 km. the signal strength was unchanged by varying the height of the aeroplane from 100 metres to 12,000 metres. Below 100 metres the signals fell off, and vanished altogether below 30 metres.

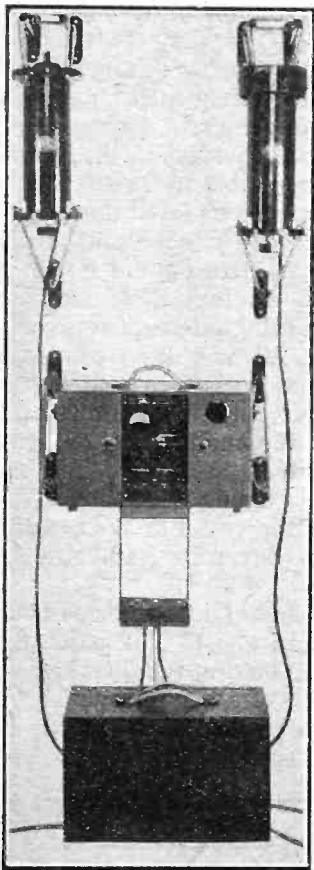

Fig. 3.—The 3-metre transmitter (left) and receiver (right) used for two-way working. Above is the high-frequency equipment hung on springs, and below the amplifier and battery boxes.

which a 70-watt transmitter, using a dipole aerial, was erected on a tower in Jena.

The flight was carried out between Berlin and Nuremberg and the transmitter was first heard at a distance of 45 km. from Jena and at a height of 600 metres, the signal strength being R4 to R5. At a height of 1,000 metres the strength was R9 to R10. On flying farther for a distance of 50 to 80 km. the signals remained approximately constant in strength, but at 100 km. they vanished completely. On the return flight the transmitter was first heard at a range of 40 km. at a height of 500 metres. Reception could be continued to a distance of 90 km. beyond the transmitter, although the aeroplane was flying at only 350 metres. At a greater range than 90 km. signals were no longer appreciable.

A 7

It is to be noticed that reception only began when the aeroplane was broadside on to the transmitter, and was at its best as the aeroplane flew away from it. This phenomenon is accounted for by the screening produced by the lower plane which, situated below and in front of the cabin in which the receiver was placed, came between receiver and transmitter as the aeroplane approached the latter.

The results observed certainly seem to bear out the theory just outlined: reception is seriously upset by the effects of screening.

Further Series of Experiments.

A second investigation was made, in conjunction with Professor Esau, by placing another transmitter of higher power on the peak of the Brocken, in the Harz Mountains, at a height of 1,140 metres above sea-level (Figs. 4 and 5). Reception was best north-east of the Brocken, where the country is more or less flat, and from whence the peak can always be seen. According to the theory, the possible range should be about 110 km.

For the transmitter a Telefunken valve, type RS220g, was used, and the wavelength was 3.2 metres, transmitting taking place from a vertical dipole aerial 1.6 metres long. The receiver was that which had already been used in the aeroplane. Reception could be carried out without any aerial, or with a horizontal aerial 2.5 metres long, or with a vertical aerial of length about 8 metres.

At first the transmitter was erected at ground level on the Brocken. The range was 76 to 100 km., and within this distance the signal strength was practically constant. Beyond this distance it decreased with extraordinary

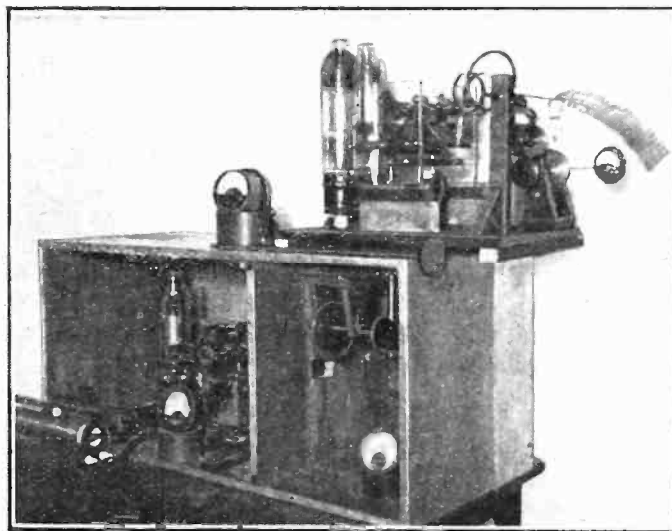

Fig. 4.—Separately controlled 6-metre transmitter with a power of 600 watts.

rapidity, the width of the region over which this rapid decline took place being from 6 to 15 km. It is to be assumed that in this region (the "boundary region") reception is no longer carried out by the aid of direct radiation, but depends on indirect refracted rays.

In further experiments the power of the transmitter was altered, in steps, over a total range of 80 to 1. In this way it was shown that up to a distance of 70 km. reception was always possible, whatever the power used,

Some Applications of Ultra Short Waves.—

though the signal strength naturally varied. At distances greater than 79 km. from the transmitter the signal strength fell away rapidly, and at distances greater than 85 km. reception was only possible with the highest power in use. This series of experiments shows that the range of ultra-short waves does actually conform to the theory given above, and is mainly determined by the distance of the horizon. In consequence, the power used by the transmitter has but a small influence on the range attained.

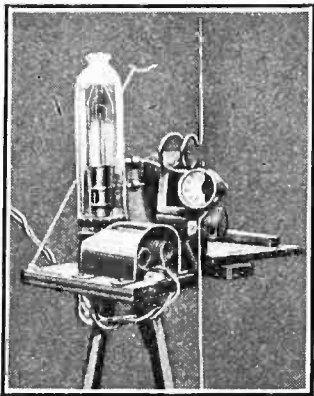

Fig. 5.—The powerful 3-metre transmitter erected on the peak of the Brocken. The dipole aerial is shown.

For a further series of experiments the transmitter was put on the stone tower which stands on the peak of the Brocken. In one direction it was found possible to show a gain of 20 km. over the previous range.

It is interesting to note that the use of an aerial for reception resulted in practically no improvement in signal strength. This, however, only applies to the region within which the radiation from the transmitter was received directly. In the "boundary region," where reception is apparently due to refracted, and not to direct, rays, a small increase of range could be attained by connecting up an aerial. This increase amounted to about 25 per cent. of the range possible by reception of the direct rays.

As a further test of the theory another series of experiments was undertaken, the transmitter being placed about half-way up the Brocken, at a height of 500 metres above sea-level and about 350 metres above the surrounding country. The transmitter was placed on a tower 16 metres high so as to cut out as far as possible the effects of the proximity of the ground. The range within which the signal strength remained approximately constant was about 66 km., while at 77 km. reception faded out entirely. Again it was found that it made no difference whether an aerial was used or not.

Experiments Confirm Theory.

All the results of these researches are in more or less good agreement with the theory that has been given. The importance of this fact for the practical applications of the ultra-short waves is very great, for, as is now quite clear, the range of the direct ray depends entirely upon the elevation of the transmitter and the receiver. To what extent long ranges depending on refraction in the Heaviside layer can be attained with ultra-short waves is a matter that has not yet been fully investigated. It would naturally be of great importance if indirect rays did not arise in the same way with ultra-short waves as with those of greater wavelength, for then any results that might be found possible would be absolutely reliable. It is true that Alexanderson, in America, has found that long-range reception attributable to refraction in the

Heaviside layer can be attained, for his transmitter has been heard in South America. It would appear, however, that refraction only takes place in a north-and-south direction, determined, it would seem, in some way by the magnetic field of the earth.

Many Applications for Ultra-short Waves.

The results which have been attained during the experiments described show that the ultra-short waves have certain distinctive properties. They have a range which, as the theory already discussed shows, is readily controlled; they are largely independent of disturbances, whether atmospheric or of local origin; they are free from fading, on account of the absence of a refracted ray; they can be modulated at very high frequencies, and they are very readily made highly directional. Hahnemann, of the Lorenz Company, consequently suggests the following applications as particularly suitable for these characteristics: It would appear always to be advisable to put the transmitters on towers, and one might perhaps put three reflectors and three transmitters on the top of a tower, as suggested in Fig. 6, so that three separate beams are radiated, each beam being interrupted according to some signal in Morse. If any kind of vessel comes into the beams there is at once the possibility of directing it as from a lighthouse. If, for example, the Morse signals chosen are for the middle section, two dashes, for the right-hand sector, three dots, and for the left-hand sector a dash alternating with three dots, it at once becomes possible for the vessel to keep within the middle sector, and so to direct its path straight towards the tower.

In a similar way two beams could be transmitted from a ship, one pointing to port and one to starboard, the two transmitters sending out, as before, different signals in Morse. In this way a substitute is provided for the vessel's lights that would be of great value in foggy weather. Hahnemann suggests that ultra-short

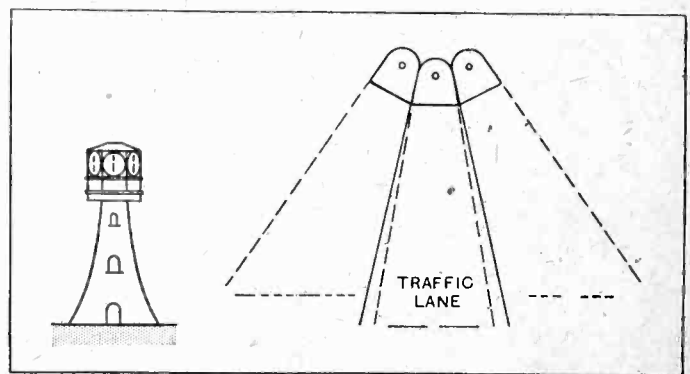

Fig. 6.—Radio-Lighthouse using ultra-short waves as an aid to navigation.

waves will also find application to aeroplanes, and is of the opinion that they may eventually replace trunk lines for inland telegraphy. It would only be necessary to erect towers at suitable distances apart (see Fig. 7) and to fit each with two directional equipments pointing in opposite directions, one to be used for transmission and the other for reception. A tower of this kind would act as a relay. The separation between the towers, and their height, would be chosen according to the range

Some Applications of Ultra Short Waves.— required. The ultra-short waves offer the possibility of a very sharply defined beam, so that high efficiency

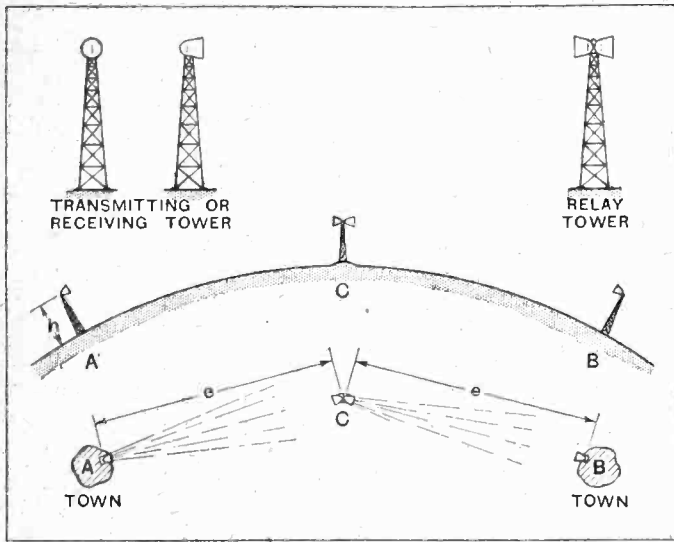

Fig. 7.—Arrangement of a line of beam station relays for ultra-short waves.

could readily be obtained. Complicated and unreliable amplifiers can therefore be avoided. Hahnemann further points out that ultra-short waves offer unusual possibilities for multiple telegraphy and telephony on the one basic wave, in which the several modulating waves are superimposed on the basic wave, and each of the modulating waves carries a different telegraphic or telephonic message. The ease of modulating the ultra-short waves at very high frequency is alone enough to permit a multiple application of this. The sharpness of a directed beam, together with the erection of both transmitters and receivers on towers, should make unauthorised listening practically impossible, so that the requirement of secrecy should be amply met.

Hahnemann has only suggested a few applications. It is known to the writer that attempts have been made to introduce ultra-short waves into railway working for communication between the driver of the train and the rest of the staff on board. It is said that the results have been most encouraging.

On the technical side so much progress has been made that properly designed transmitters and receivers are available. It therefore seems justifiable to assume that it can only be a matter of time before the ultra-short waves find considerable practical applications.

TESTING LOW-TENSION A.C. CIRCUITS.

The four-volt low-tension circuits of receivers with indirectly heated A.C. valves are not particularly susceptible to troubles, but nevertheless, occasion sometimes arises for testing their continuity and for assuring one's self that the appropriate sockets of each valve are receiving the necessary voltage. It is useful to remember that a flashlamp bulb, of which the voltage rating is approximately correct, can be used as a test lamp or indicating device. A suitable holder for these lamps, to which a pair of flexible leads may be connected, is obtainable for a few pence.

By noting whether the lamp is glowing at normal brilliancy, it is possible to form a very good idea as to whether the voltage delivered by the heating transformer is reasonably correct.

o o o o

A QUICK CONDENSER TEST.

Various simple methods of testing the insulation of fixed condensers, and even of forming a rough idea as to whether their capacities are substantially correct, have been put forward, but unfortunately most of them take a certain amount of time to put into execution. Now in a

Practical Hints and Tips.

modern mains receiver there may be about two dozen of these components, in various capacities, and an extended test of each of them is a lengthy business. A good idea as to the insulation resistance of a condenser may quickly be obtained by noting the effect of making successive contacts across its terminals when using the phones-and-battery method. On first closing the circuit, a click, depending in intensity on the capacity of the condenser, will be heard, but when it is fully charged to a potential equal to that of the testing battery, no click should be audible.

If clicks of approximately the same loudness occur at each contact, it can definitely be assumed that the insulation resistance of the condenser is at least poor, or even that it has completely broken down. Of course, before making the test, one should assure oneself that there is no parallel path for current, and if necessary disconnect one of the terminals.

INSTABILITY ON LONG WAVES.

When a set with an S.G. high-frequency valve or valves is instable on the long-wave band, but performs satisfactorily when medium wavelengths are being received, the trouble is generally attributed to the action of H.F. currents in the L.F. amplifier. It is a fact that the usual arrangements for separating H.F. and L.F. components in detector anode circuits become less and less effective as wavelength is increased, and so this conclusion is often justifiable. But it must not be forgotten that the trouble may almost equally well be due to falling-off in the effectiveness of "decoupling" devices; the working value of the resistances used in these systems remains constant irrespective of wavelength, but the reactance of the associated condensers increases rapidly with increase of wavelength. Consequently, the filtering action of these devices becomes less effective as wavelength is increased, and long-wave instability may quite possibly be due to stray couplings brought about by voltages set up in the common source of anode current supply, whether it be a battery or an eliminator. The remedy, of course, is to fit considerably larger bypass condensers.

Practical Hints and Tips.—

THE BASE LINE.

Theoretical diagrams of mains-driven receivers are getting almost alarmingly complicated, or at any rate they appear to be so on casual examination. Their complexity is, perhaps, rather more apparent than real, as most difficulties will disappear if the circuit is mentally divided

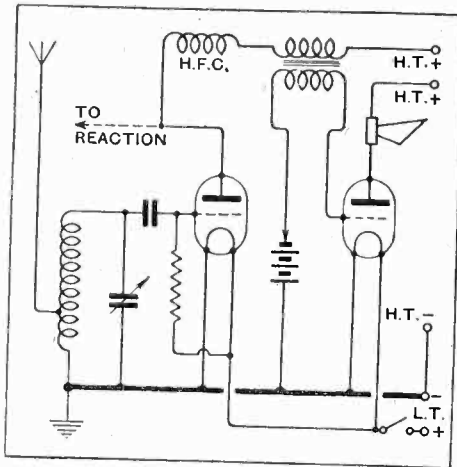

Fig. 1.—By drawing the earthed L.T. negative H.T. negative busbar as a heavy line, a clear starting point for tracing individual grid or plate circuits is provided.

into its component parts—H.F. amplifier, detector, L.F. amplifier, and eliminator—but even then there may sometimes be need for a wet towel when one is called upon to tackle the theoretical representation of, say, an elaborate A.C. mains set with free grid bias—which addition is perhaps the villain of the piece, and responsible for many of our perplexities.

To make matters easier, some contributors to these pages have prepared their circuit diagrams with a heavy base line, which will serve as a "point of departure" in tracing out the individual plate and grid circuits of each valve. This seems to be a move in the right direction, and may even be helpful when dealing with comparatively simple battery sets. The principle is illustrated in Fig. 1, which is the circuit diagram of the simplest possible two-valve det.-L.F. receiver. In this case the base line is the common H.T. negative-L.T. negative busbar, which is almost invariably earthed. Even if it is not (a metallic connection between filaments and earth is undesirable, for example, in a D.C. mains set), this busbar should still be regarded as the base line around which the rest of the circuit is built up.

In the diagrams of sets with indirectly heated A.C. valves and without "free" grid bias, the base line is obviously the busbar to which all cathodes and the H.T. negative input are connected. When free grid bias is added there is a tendency to regard the H.T. negative connection as the starting point, but this is likely to lead to confusion, and so it is best still to regard the cathode connection as the base line, remembering that bias voltage will be developed across the resistance joined between one or more cathodes and the H.T. negative terminal. This is indicated in Fig. 2, which represents an imaginary receiver circuit in which bias for the H.F. and output valves is taken from a potentiometer inserted in the low-potential end of the common anode circuit. As is usual with indirectly heated valves, the grid detector works with a zero grid.

In studying a diagram of this kind it is convenient at first to ignore everything but the "signal frequency" part of the grid circuit; thus we should consider that these parts of the H.F. and L.F. amplifying

tion regarding its alteration or testing, reference is often made to the "low-potential end" of an anode circuit. This expression seems to puzzle some wireless amateurs: as it is a useful one, often saving a good deal of verbiage or sketching of diagrams, a word of explanation may not be out of place.

As generally understood, the expression refers to that end of the anode working load—transformer primary, choke, resistance, etc.—which is remote from the end that is connected to the anode of the valve. Any incidental components, such as decoupling or voltage-absorbing resistances, fuses, or meters that are connected between this point and the source of H.T. supply, are referred to as being at the low-potential end of the circuit. Actually, with regard to D.C. voltage, they are at higher potential than is the anode, but in this case we are dealing with high- or low-frequency signal impulses.

Similarly occasion often arises to refer to the "grid return lead." This

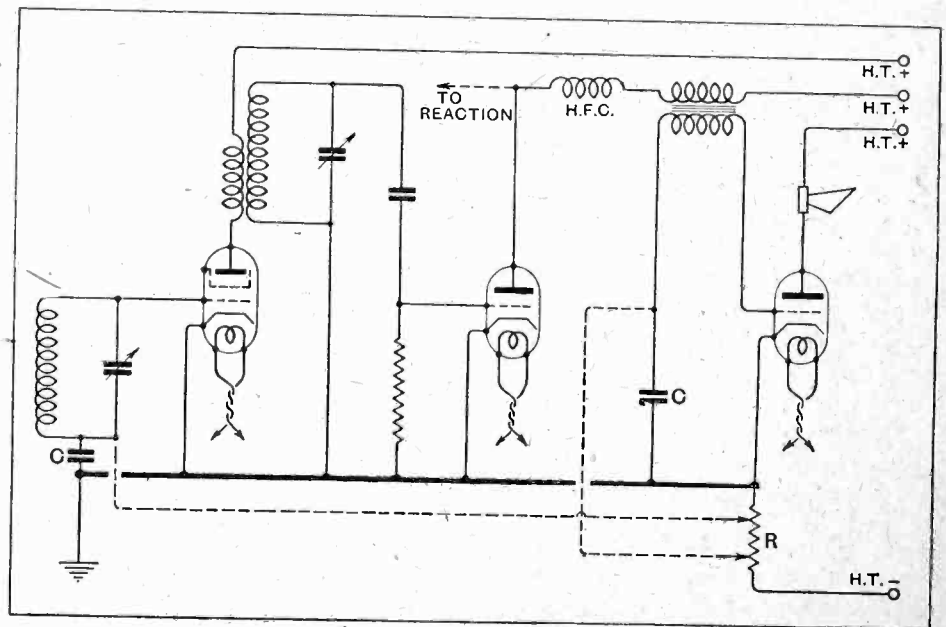

Fig. 2.—The "base line" of an A.C. mains receiver with free grid bias. Decoupling devices, etc., are omitted.

valves are connected to their respective cathodes through the bypass condensers C, which would invariably be found in a practical design.

DEFINITIONS.

In describing the features of a receiver, and when giving informa-

lead may be defined as that joining the end of the "working" grid circuit component—transformer secondary, tuned coil, grid leak, etc., to the cathode or negative filament socket. Bias cells, for example, are said to be inserted "in the grid return lead."

The PENTODE *and* POWER OUTPUT

The Causes and Prevention of Distortion.

By E. YEOMAN ROBINSON,

(Chief Engineer, Radio Valve Dept., The Cosmos Lamp Works Ltd.).

A GREAT deal of attention has lately been given to the calculation of undistorted output available to work a loud speaker, for without a knowledge of this factor it is difficult to compare the merits of different power valves and to predict what volume of sound will be obtainable from the speaker. As a rough guide it is usual to assume that from 700 to 1,000 milliwatts are necessary when a moving-coil speaker is used in an ordinary sized living-room, while most moving armature speakers will be satisfied with 500 to 600 milliwatts. For a small hall 1,500 milliwatts upwards will be necessary. When considering the power output of a triode it is usual to define the maximum undistorted output as the maximum power output which can be obtained with the production of a 5 per cent. second harmonic component.

In the case of a pentode the *third* harmonic is often greater than the second, and, therefore, the maximum undistorted power output of a pentode is given for a 5 per cent. third harmonic or a 5 per cent. second harmonic, whichever be the greater. This is determined in the manner shown below. In practice it is found that maximum undistorted power output occurs when the second harmonic distortion is practically zero. The optimum load must be found by methods of trial and error; as a first approximation the load to give about zero second harmonic should be determined.

The new indirectly heated pentode—the Mazda AC/Pen—will be taken as an example. The optimum load line for this valve is shown at CC¹ in Fig. 1, and is for a resistance of 10,200 ohms. Since grid current does not flow at negative grid voltages the grid can swing to zero grid volts, consequently the total grid swing ranges from 0 to -20 volts, for

the optimum bias is -10 volts when the screen potential is 200 volts. The dynamic characteristic for the above conditions of operation is plotted in Fig. 2. It will be seen that P₁, P₀ and P₂ lie nearly on one straight line, so that the second harmonic is very small.

The second harmonic may be computed in the usual manner from expression (a) in the appendix.

It will be seen that the dynamic curve on the right-hand side of the mean P₀ is concave upwards, whilst the curve on the left of P₀ is concave downwards. This curvature gives rise to the production of a third harmonic component. To obtain

the percentage third harmonic distortion the curvature of the characteristic from P₁ to P₀ should be measured, and that from P₀ to P₂, and a mean value determined. To simplify the measurement it is usual to take the curvature from P₀ to P₂ only, i.e., on the upper half of the dynamic curve, provided it is not appreciably greater than 5 per cent. This gives a factor of safety, because under correct operating conditions the curvature from P₁ to P₀ is always less.

Referring to Fig. 1 at E_g=0; E_g=-5, E_g=-10, the anode current characteristics cut the load line at 47, 39.5 and 30 milliamperes respectively. For upward curvature (Fig. 2) the distortion formula is given by expression (b) in the appendix, and it is there shown that the third harmonic distortion is about 5.9 per cent.

The power output is equal to I²R when I is the R.M.S. value of the A.C. component of the output current. This current fluctuates from 14 to 47 milliamperes, i.e., the A.C. current is $\frac{47-14}{2} = 16.5$ mA. (peak) $= \frac{16.5}{\sqrt{2}} = 11.65$ milliamperes R.M.S. The power output is therefore $(11.65)^2 \times 10,200 \times 10^{-6} = 1,390$, roughly, 1,400 milliwatts.

OWING to the peculiar characteristics of the pentode the calculation of suitable speaker impedance and the available undistorted output is not susceptible to the same treatment as that of a triode. Often the distortion due to the third harmonic is greater than that of the second; in this article the method of measuring distortion is clearly described, and it is shown how by the use of a milliammeter the presence of the second and third harmonic components may be detected and prevented

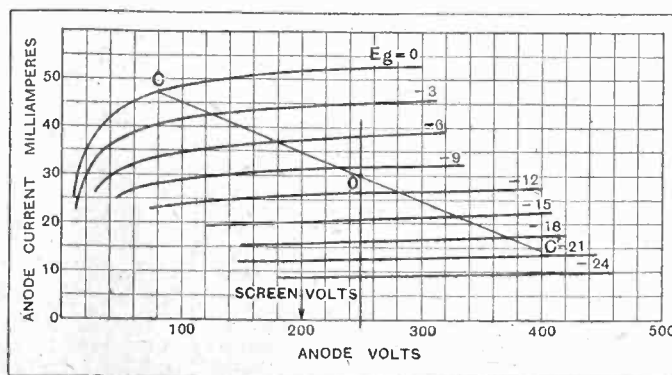

Fig. 1.—Anode volts/anode current curves of an AC/Pen valve. The line CC¹ represents a load of 10,200 ohms and O is the operating point. The maximum screen and anode volts are 200 and 250 respectively.

The Pentode and Power Output.—

The true secret of obtaining satisfactory results from a pentode lies in paying attention to the value of the load impedance, for should this be too low the power output will be small, whilst if it is too high serious harmonic distortion and over-voltages will be produced. It is therefore of interest to observe the power output and distortion at loads other than the optimum. Fig. 3 shows the dynamic characteristics of the A.C./Pen. valve for various values of load resistance, whilst in Table I this information is given in tabular form. Columns 3 and 4 give the percentage of second and third harmonics present respectively when a grid swing equal

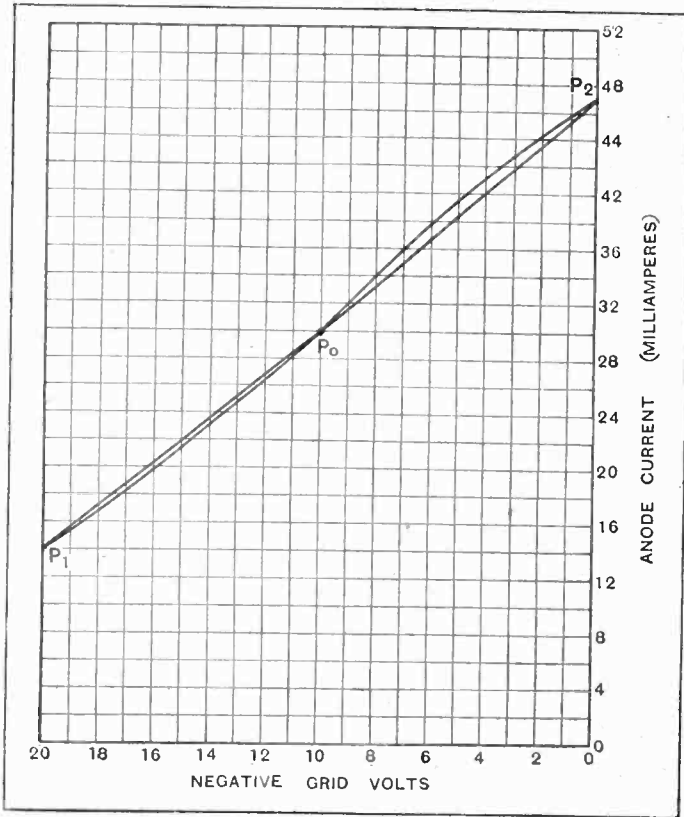

Fig. 2.—Dynamic characteristics for the conditions given in Fig. 1.

to the grid bias is applied to the valve, *i.e.*, the maximum grid swing for the optimum load impedance of 10,200 ohms.

Referring once more to Fig. 3, it will be seen that owing to the peculiar shape of the dynamic characteristic curvature distortion on high-load resistances can be avoided by reducing the grid swing. For example, with a 20,000 ohms load the dynamic curve is sensibly straight if the grid swing is restricted to 5 volts. This characteristic feature is important, for whereas the load impedance must not rise above 10,000 to 12,000 ohms under ordinary conditions of working (if the harmonic distortion is to be not more than 5 per cent.), assuming the signal strength has already been reduced at high frequencies by side band cut-off, etc., the load impedance can be permitted to rise to comparatively high values at these frequencies without distortion occurring. It is estimated that actually a harmonic distortion up to 10 per cent. can be employed in practice when a

moving-iron type loud speaker is used, and therefore columns 5 and 6 have been added to Table I.

These columns give respectively the maximum power output available when the distortion is limited to 10 per cent., and the maximum grid swing which is permissible for this restriction in harmonic distortion. From this it will be noticed that whilst with a 30,000 ohms load and a 10 volt grid swing the third harmonic is 19.4 per cent., this distortion is reduced to 10 per cent. if the grid swing is restricted to 7 volts.

Advantages of the Pentode.

There are two main reasons for employing a pentode instead of a triode. One is to obtain greater sensitivity, and the other to obtain "brilliant" loud speaker reproduction by accentuating the high audio-frequency notes and thus compensating for the inferior performance of the loud speaker at high frequencies, and for side band cut-off and various capacity losses. The best load impedance to adopt will depend entirely on the impedance-frequency characteristic of the speaker, and whether the speaker, the set, or the transmission is responsible for the loss of high audio-frequency notes. To simplify consideration of the problem it is best to consider the use of the A.C./Pen. valve under three different conditions:—

Case 1.—Consider the case in which there is no appreciable high-note loss in the amplifier, and likewise there is no lack of high audio-frequency reproduction in the speaker. The A.C./Pen. valve is used to obtain greater sensitivity.

Under these conditions the movement of the speaker should be such that the impedance is substantially constant over the working frequency range; an output transformer should be used to adjust the load on the valve to 10,000 ohms. Preferably a tapped choke should be used in order to reduce the leakage reactance which, by increasing the impedance at high audio-frequencies, will cause harmonic distortion. Since the impedance of practically all loud speakers increases with frequency, a limiting resistance load should be placed across the choke as shown in Fig. 4. To prevent the resistance reducing the power delivered to the speaker except at high audio-frequencies a condenser should be connected in series as illustrated. The best value of the resistance

TABLE I.

OUTPUT CHARACTERISTICS OF MAZDA A.C./PEN VALVE.

1 Load (ohms).	2 Undistorted power output (Milliwatts).	3 Second harmonic Distortion (Per cent.).	4 Third harmonic Distortion (Per cent.).	5* Max. output for 10% distortion. (Milliwatts).	6 Max. grid swing for Column 5, (volts).
2,000	370	7.1	3.0	370	10
4,000	670	6.2	2.8	670	10
6,000	970	5.5	2.7	970	10
8,000	1,160	4.4	2.5	1,160	10
10,000	1,400	1.5	5.3	1,400	10
12,000	1,400	0.8	5.8	1,400	10
14,000	1,420	0.9	7.9	1,420	10
16,000	1,520	2.7	8.4	1,520	10
18,000	1,560	4.3	10.3	1,560	10
20,000	1,570	6.0	11.6	1,200	8.5
30,000	1,580	15.8	19.4	1,000	7.0

* With input limited to 10 volts swing.

The Pentode and Power Output.—

will depend entirely on individual conditions. A resistance of 15,000-25,000 ohms and a series condenser of 0.003-0.01 are suitable according to conditions. When an output transformer is employed the resistance and series condenser should be across the primary of the transformer to eliminate, as far as possible, the effects of leakage reactance of the transformer.

Case 2.—The pentode is used to compensate for poor high audio-frequency reproduction from the speaker.

In this case the characteristic of the pentode that an increased load gives increased power output is utilised. The speaker movement should have an impedance rising with frequency. To avoid harmonic distortion the transformer ratio should be chosen so that the load impedance is 10,000 ohms at the *highest frequency* at which it is desired to boost the high notes. For example, consider a speaker having an impedance characteristic as given in the table below:—

TABLE II.

Frequency	250	500	1,000	1,500	2,000	3,000	4,000	6,000
Impedance	5,500	8,000	10,000	12,000	13,000	16,000	18,000	22,000

With a 1/1 transformer the high notes up to 1,000-1,500 cycles will be boosted. To prevent distortion at

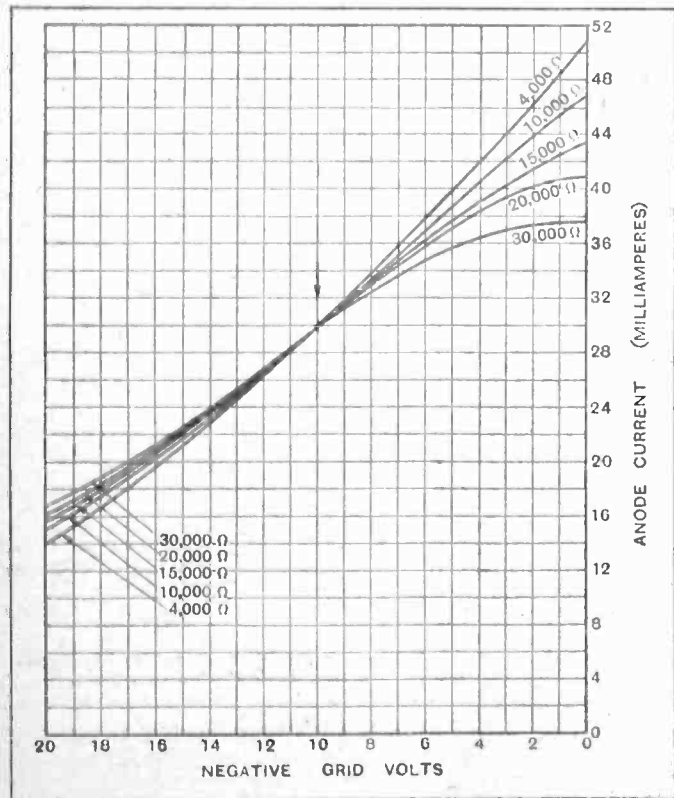

Fig. 3.—Dynamic curves of AC/Pen for various load resistances.

frequencies higher than 1,500 cycles, a by-pass resistance and a series condenser must be used. Suppose, however, it is desired to boost the frequencies up to 3,000 cycles. For the purpose a 1/1.25 transformer would be required, and the series condenser should be

decreased in capacity to bring the by-pass resistance into operation at a higher frequency.

Case 3.—The pentode is used to compensate for high audio-frequency loss in the amplifier due to sideband cut-off, poor transformers, or an inferior gramophone pick-up.

In this case, if the high audio-frequency signal has been relatively reduced in amplitude, the load impedance can be permitted to rise to even 30,000 ohms without distortion. A by-pass resistance is hardly necessary, but if used it should have a value of 30,000 to 40,000 ohms.

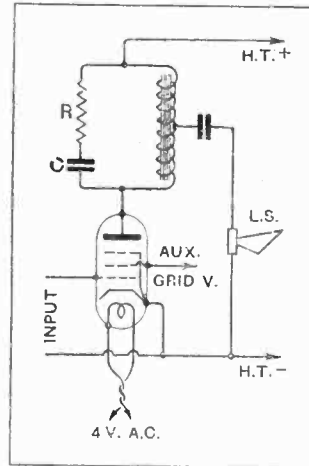

Fig. 4.—A suitable output circuit for a pentode. The filter CR prevents accentuation of the higher audio frequencies with certain loud speakers.

The impedance and response characteristics of various loud speakers are so widely different that it is impossible to give any generalised formulæ for employing a pentode. The easiest way to analyse what is occurring is to place a milliammeter in the anode circuit of the valve. If when a strong signal is applied, the milliammeter needle flicks upwards, second harmonic distortion is occurring, and a greater load impedance will reduce this second harmonic distortion and give increased power output. If, on the other hand, the needle dips downwards, third harmonic distortion is produced, and the load impedance must be correspondingly reduced. If the third harmonic distortion is only occurring at high frequencies, it can be prevented by varying the values of the by-pass resistance and series condenser. It should be remembered that the optimum output impedance is dependent upon the anode voltages and screen voltages employed. For example, with a screen voltage of 200 the optimum impedance for an anode voltage of 250 is 10,200 ohms. With an anode voltage of 200 the optimum load impedance is only 8,000 ohms. This voltage is the actual anode voltage on the valve, and it will be found with many pentode chokes and output transformers as much as 40 or 50 volts may be dropped in the choke, so that, to obtain a voltage of 250 at the anode, a supply voltage of 290 to 300 volts may be necessary.

Greater Stability with the A.C. Valve.

The fact that the A.C./Pen. valve is fitted with an indirectly heated cathode may be utilised to advantage when the valve is employed in a set equipped with one or two screened high-frequency stages. In such sets one cause of possible instability is back coupling through the heater wiring. This is prevented by connecting the heater wiring to the cathode. If an ordinary filament pentode is employed, the cathodes of the early-stage valves are connected to the centre tap of the fila-

The Pentode and Power Output.—

ment transformer secondary, or to the centre tap of the potentiometer connected across it. Inasmuch as there must be some impedance between the heater wiring and the cathode, feed-back may be introduced. This can be completely avoided when an indirectly heated output valve is used by connecting all the cathodes in parallel to one end of the heater transformer secondary winding.

After reading this article the reader may feel that the problem of using a pentode is hedged around with many difficulties, for the working impedances of loud speakers are not widely known. It was stated¹ recently in *The Wireless World* that "... properly used it is believed that the pentode will give as satisfactory reproduction as a triode, and it is quite certain that no valve will give as many milliwatts output per volt input." It is hoped that the information given will enable the conditions for satisfactory use to be realised. After all, the only real difficulty of making a pentode give the same quality of reproduction as a triode is to keep the load at all frequencies as far as possible the same,

¹ See "The Power Pentode Two," May 7th, 1930, p. 477.

UNLIMITEX LOUD SPEAKER MOVEMENT.

In these days of cone diaphragms and moving coils it is interesting to find an example of a unit designed for use in conjunction with a horn. The Unlimitex unit is undoubtedly a distinct advance over the old-fashioned soft iron diaphragm movement at one time associated with horn loud speakers. The diaphragm is spun from thin aluminium sheet with a conical depression in the centre surrounded by concentric corrugations to give the

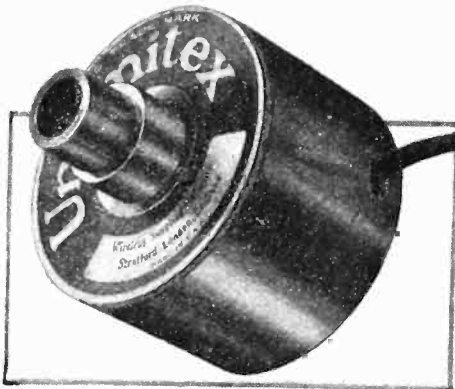

Unlimitex balanced armature unit for horn loud speakers.

requisite degree of flexibility. The edge is clamped between rubber rings which effectively damp out any metallic quality in the reproduction. A balanced armature movement of substantial dimensions is coupled to the apex of the diaphragm through a short, thin rod, and the air gap is sufficiently wide to prevent chattering.

The unit was tested in conjunction with a folded exponential horn having a cross section of four square feet at the flare. Using a super-power output valve capable of delivering 1,000 milliwatts, no trace

LABORATORY TESTS on New Apparatus.

A Review of Manufacturers' Recent Products.

of chattering could be provoked, but it was noted that the sensitivity was somewhat lower than that of the average cone loud speaker, possibly due to the size of the air gap. The bulk of the acoustic output lay between 300 and 1,750 cycles with detectable resonances at 400 and 1,500 cycles. The unit definitely responds to frequencies as high as 6,000 and as low as 50, but the output outside the limits from 300 to 1,750 is comparatively small. The impedance rises from 1,820 ohms at 50 cycles to 28,600 ohms at 6,000 cycles with an average value at 800 cycles of approximately 10,000 ohms.

The price is 18s. 9d., and the makers are Wireless Supplies, Unlimited, 278, High Street, Stratford, London, E.15.

FRANKLIN FIXED CONDENSERS.

A new range of condensers available in capacities up to 0.0005 mfd. with mica dielectric, and up to 10 mfd. with paper dielectric, is now available from the Franklin Electric Company, 187-189, Ilford Lane, Ilford, Essex. These condensers are housed in metal containers

and keep it close to the optimum value. This optimum is, in the case of pentodes, much more sharply defined than in the case of triodes. Whereas the average listener may be unable to determine aurally the difference in performance of a triode working a moving-coil speaker with transformer ratios of 10/1 and 30/1, with a pentode a difference can be determined between such comparatively close ratios as 20/1 and 25/1. The high power output and phenomenal sensitivity of the A.C./Pen. valve are so marked that the extra attention to the load which is necessary to obtain pure reproduction is well worth while.

APPENDIX.

For the calculation of second harmonic the following expression is used :

$$\frac{\frac{1}{2}(I. \text{ max.} + I. \text{ min.}) - I_0}{I. \text{ max.} - I. \text{ min.}} \times 100\% \dots \dots \dots (a)$$

In the case under discussion this becomes

$$\frac{\frac{1}{2}(47 + 14) - 30}{47 - 14} \times 100 = 1.5\%$$

The expression for third harmonic distortion is

$$I_0 - \frac{1}{2}(I. \text{ max.} + I. \text{ min.}) \dots \dots \dots (b)$$

Taking the case mentioned in the text we have

$$\frac{39.5 - \frac{1}{2}(47 + 30)}{17} \times 100 = \frac{39.5 - 38.5}{17} \times 100 = 5.9\% \text{ approx.}$$

and are provided with either screw terminals or soldering tags. In view of the arbitrary ratings now applied to large capacity condensers, a six months' guarantee is given that Franklin condensers will not break down if the rated working conditions are not exceeded. For the purposes of test a 1 mfd. condenser rated as suitable for 160 volts A.C. or 240 volts D.C. and labelled as withstanding a test voltage of 500 D.C. was left in circuit on

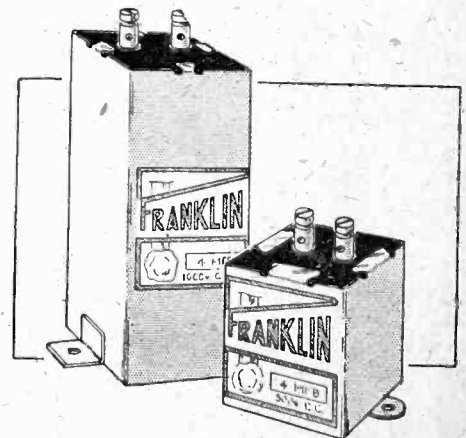

Two examples of the Franklin fixed condenser reviewed on this page.

a steady 1,000 volts supply. It withstood this test without breakdown as well as the severe conditions imposed by repeatedly discharging by short circuit.

The prices are, 1 mfd. size 2s., 500-volt D.C. test class, 2s. 6d. for the 500-volt A.C. test class, and 2s. 6d. for the 1,000-volt D.C. test class. Other types are available carrying ratings up to 5,000 volts D.C. test, and the condensers are moreover available in block form for use in eliminators.

"ELECTROFICIENT" MAINS TRANSFORMER 4 IDH AND L.F. CHOKE.

Made by Messrs. Graham Farish, Ltd., Masons Hill, Bromley, Kent, these two components form the basis of a battery eliminator for A.C. mains. The type 4 IDH transformer has been designed for 210-volt 50-cycle supplies, and is intended for use with a valve rectifier of the 4-volt class. Full-wave rectification is allowed, the H.T. secondary winding being centre-tapped. In addition, there is a 4-volt coil rated to deliver up to 5 amps of current for the indirectly heated type of A.C. valves.

Some measurements were made of the A.C. output from the various windings on load. Each half of the H.T. secondary coil was tested separately, but as their outputs were sensibly the same, the readings obtained from one half only will be given here. The input voltage was maintained at 210 volts throughout these tests. With a load of 5 mA. the A.C. voltage was 241, at 20 mA. 237.5, and at 40 mA. 231 volts. These are R.M.S. values. It will be seen that the regulation is very good.

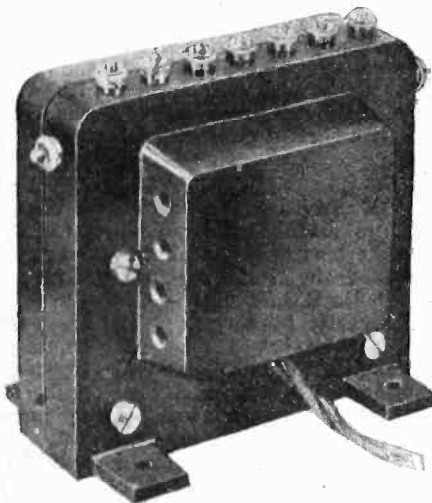

"Electroefficient" mains transformer, type 4 IDH.

The voltage given by the 4-volt 5-amp. coil was as follows:—

R.M.S. current in Amps.	R.M.S. volts.
1	4.3
2	4.13
3	4
4	3.85
5	3.67

The rectifier filament coil gave 4.1 amps on a load of 1 amp., and 3.9 volts at 2 amps. The price of this transformer, which is enclosed in a bakelite case, is 39s. 6d.

The choke, which is a complementary component, being housed in a similar case, and price at 22s. 6d., has a nominal inductance of 30 henrys, and rated to carry 50 mA. It is provided with a centre tap. Its measured inductance at

50 cycles was found to be 56.5 henrys without D.C. flowing, 54.25 henrys with 10 mA., 50.2 henrys with 20 mA., 45.25 henrys with 30 mA., 40 henrys with 40 mA., and 34.8 henrys with 50 mA. of D.C.

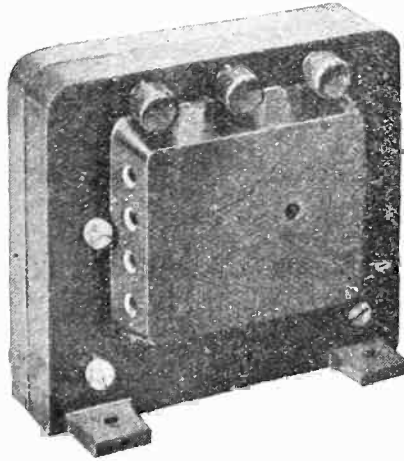

"Electroefficient" H.T. smoothing choke.

During test the A.C. volts across the choke were maintained at 50, and the R.M.S. current increased progressively from 2.6 mA. to 4.3 mA. as the impedance fell. With the maximum permissible value of D.C. flowing the inductance is sufficiently high to assure adequate smoothing of the rectified voltage when used in conjunction with about 8 mfd. of capacity.

o o o o

BAYLISS ROTARY CONVERTER.

The function of this machine is to provide an A.C. supply from the direct current mains, thereby enabling power amplifiers, radio-gramophones, and similar apparatus designed for A.C. operation to be used in these cases. At one end of the armature is fitted a 38-section commutator and at the other end two slip rings, while on an extension of the spindle is carried a small fan. This maintains a constant current of air through the armature tunnel and prevents undue heating of the coils. On test there was no appreciable

contact sockets on this block are the ends of the field winding. Another terminal block, similarly covered and mounted on the top of the casing, gives connection to the A.C. winding. Under normal conditions a small machine of this type would be series connected—our tests were carried out with this particular arrangement—so that one end of the field should be connected to one of the brush leads. A starter, connected in the usual way, can then be employed.

The A.C. output is nominally 150 volts at 50 cycles, but by utilising the special auto-transformers made by the same firm for use with the machine, any voltage up to 250 can be obtained. The overall efficiency is not materially affected by employing this component, as it is de-

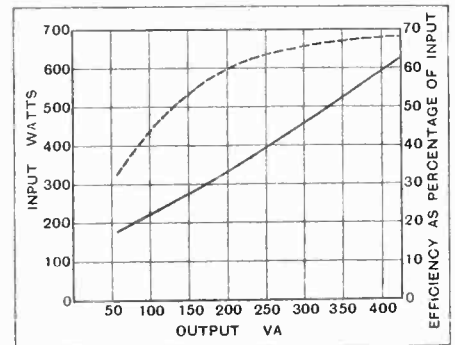

Efficiency curves of the Bayliss 400-watt rotary converter.

signed on generous lines. Curves showing the relationship to input watts and output volt/amps., also the efficiency as a percentage of the input watts, have been prepared and are reproduced here.

The maximum efficiency is of the order of 68 per cent., this being attained at an output of 400 V.A. These measurements do not take into consideration the transformer, and with this included, the overall efficiency was lowered by about 3 per cent.

The A.C. output is modulated slightly by D.C. ripple, and in most cases it will be necessary to incorporate smoothing equipment in both the input and the out-

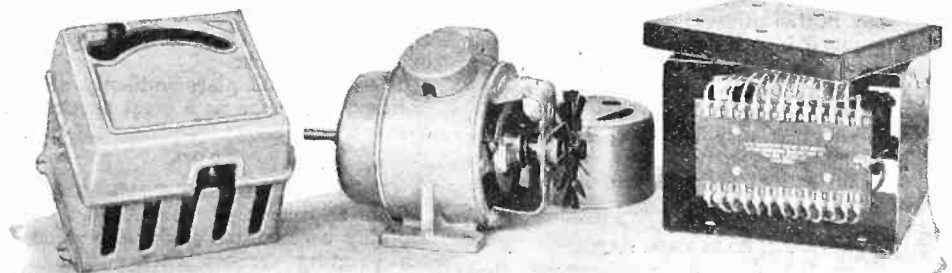

Bayliss D.C. to A.C. rotary converter with end cover removed, showing the cooling fan, Also the auto-transformer.

temperature rise even after a lengthy run on full load.

The leads from the commutator brushes are brought out to a 4-way terminal block mounted slightly to one side of the centre on the top of the field casing and protected by a circular cover. The two other

put leads. The anti-interference units specially made by the Dubilier Condenser Co. (1925), Ltd., for machines of this type were found an efficient remedy for this particular trouble.

The price of the machine, which is rated at 400 watts, is £12 10s.

SHOUTING EACH OTHER DOWN.

The "Battle of the Giants" which was forecast in our editorial articles in October and November of last year, bids fair to develop into a stentorian bawling match between the high-power station in Moscow and those in neighbouring countries who do not altogether appreciate the propaganda transmitted by Soviet Russia. Germany has formally protested against the messages broadcast on May Day from Moscow to the "Policemen and Soldiers of Germany," Rumania has a counter station which shouts down Moscow whenever it starts talking in Rumanian, and on the other side it is stated that a station is to be erected in the Volga Republic to drown the religious broadcasts from Berlin with the "Godless hour" from Moscow and prevent German settlers receiving Christian comfort from their fatherland.

Cynical prophets declare that when international disarmament is accomplished war will still be waged in the form of slanging matches through the medium of higher and higher-powered stations.

THE BRITISH ATTITUDE.

We are perhaps fortunate in the fact that the B.B.C. policy tends rather in the opposite direction, as their unwillingness to allow anything in the nature of controversial propaganda led to a refusal to broadcast any of the proceedings of the Albert Hall meeting to protest against religious persecution in Russia.

THE REIGN OF NOISE.

We often find curious contradictions in individual countries. At one end of the scale the penalties for using noisy loud speakers to the annoyance of one's neighbours are becoming more rigorous—Leipzig and Hanover, if we remember aright, are conspicuous in framing drastic regulations for the abatement of this nuisance—but at the other end of the scale of noise we hear of a new giant loud speaker in Germany which can be carried in a balloon and used to bawl information to a whole city.

FRENCH "PHANTOM" STATIONS.

The broadcasting question still arouses much heated discussion in France, and one journal, referring to the new Lille-Camplin Station, the foundations of which were recently dug, describes it as another of the "phantom" stations of France, and enquires why "two or three really good stations are not made available at once instead of a dozen mediocre or non-existent ones."

TELEARCHIC CARS.

From Barcelona it is announced that on July 4th successful trials were made of a motor car, steered by wireless from another car, which made a tour of the principal streets of the city. Our Paris correspondent sardonically remarks that this practice might well be introduced there as well as in some other French towns where to the spectator who is active enough to escape destruction the automobiles appear to be entirely without guidance.



CURRENT TOPICS

News of the Week in Brief Review.

BEWARE OF ROBBERS!

Information has recently reached us of two attempts to obtain unauthorised possession of Marconiphone apparatus. In each case the attempt took the form of a visit to the house of a customer by a man who said he had been sent to collect the apparatus. Fortunately, in both instances the customers refused to accede to this request.

All authorised Marconiphone officials and employees, we are informed, carry an identification card which they produce when calling on customers to deal with or receive apparatus, in addition to which their call is always advised by correspondence. In the absence of these safeguards our readers should refuse any requests from callers purporting to take possession of or deal with apparatus.

OBITUARY.

We regret to record the death on Monday, July 14th, of Mr. J. P. Clark, one of the Senior Engineers of the Marconi Company.

Mr. Clark entered electrical engineering as a student at Faraday House, where he passed out as a Prizeman. He was then engaged for some years in electrical engineering in Yorkshire before he joined the Marconi Company in 1913.

For a number of years past Mr. Clark had been Chief of one of the Contract Sections in the Engineering Department of Marconi House.

His death took place suddenly while on holiday, and came as a great shock to his many friends.

SMALL ADVERTISEMENTS.

The approach of the August Bank Holiday necessitates slight alterations in our printing arrangements. The latest date on which small advertisements can be accepted for *The Wireless World* of August 6th is Wednesday, July 30th.

"WIRELESS WORLD" INDEX AND BINDING CASES.

The index for Volume XXVI, January to June, 1930, is now ready, and may be obtained from the publishers, price 4d., post free, or together with binding case 3s. 1d. post free.

WIRELESS SETS FOR INVALIDS.

A fund to provide wireless crystal sets for poor invalids has been started in Newcastle by the Citizens' Service Society.

THE TELEVISED PLAY.

The first attempt to broadcast a play by the Baird system of Television has aroused considerable interest and not a little criticism in the daily Press. It seems generally agreed that the recent representation of "The Man with a Flower in His Mouth" was most interesting from a scientific point of view, but that the dramatic limitations are at present very restricted as only a portion of each actor can be shown on the screen at one time, and short interludes are necessary to enable each performer to take his place before the projector when his turn comes.

INTERNATIONAL ELECTROTECHNICAL COMMISSION.

At the opening meeting of the International Electrotechnical Commission in Copenhagen the delegates were welcomed by Mr. Bulow on behalf of the Municipality, Mr. P. Munch, the Minister of Foreign Affairs, and Prof. Pederson, President of the Danish Electrotechnical Committee, who was able to show them the actual magnetic needles with which Oersted first observed the influence of an electric current on a magnet.

NOMENCLATURE.

The Advisory Committee on Nomenclature made considerable progress with the International Vocabulary and recommended the following new names for magnetic C.G.S. units:—

Magnetic Flux	...	Maxwell
Flux Density	...	Gauss
Magnetic Flux Intensity	...	Oersted
Magneto-Motive Force	...	Gilbert

the term "Pro-maxwell" being agreed as the name for the practical unit.

Advisory Committee No. 3 on Symbols has already prepared Publication No. 27 containing electrical and mathematical symbols, rules, and abbreviations for metrical weights and measures, and has in hand the preparation of the second edition of Publication No. 35, which, beside the graphical symbols used for heavy-current installation, will include those for telephone, telegraph and radio-electricity.

NEW BROADCASTING STATION FOR AUSTRALIA.

Plans are being prepared for the erection of subsidiary broadcasting stations at Rockhampton, Newcastle and Brooklyn Park in Australia.

VALVE HISTORY IN 15 SECONDS.

The world's largest electric sign will shortly tell the complete story of the RCA Radiotron wireless valves in approximately 15 seconds, according to a publicity note from the company's offices at Harrison, New Jersey, where the sign is to be erected. Employing 4,000 Mazda lamps with a load of 134,975 watts, the sign will display the jumping notes of the theme song "Hail to the Chief" to 140 million people who pass the spot each year.

Watching the Diaphragm Vibrate

By

G. F. DUTTON,
Ph.D., D.I.C.

(The Gramophone Company Ltd.).

A Demonstration of this Apparatus was given before the Royal Society at their Conversazione on June 25th.

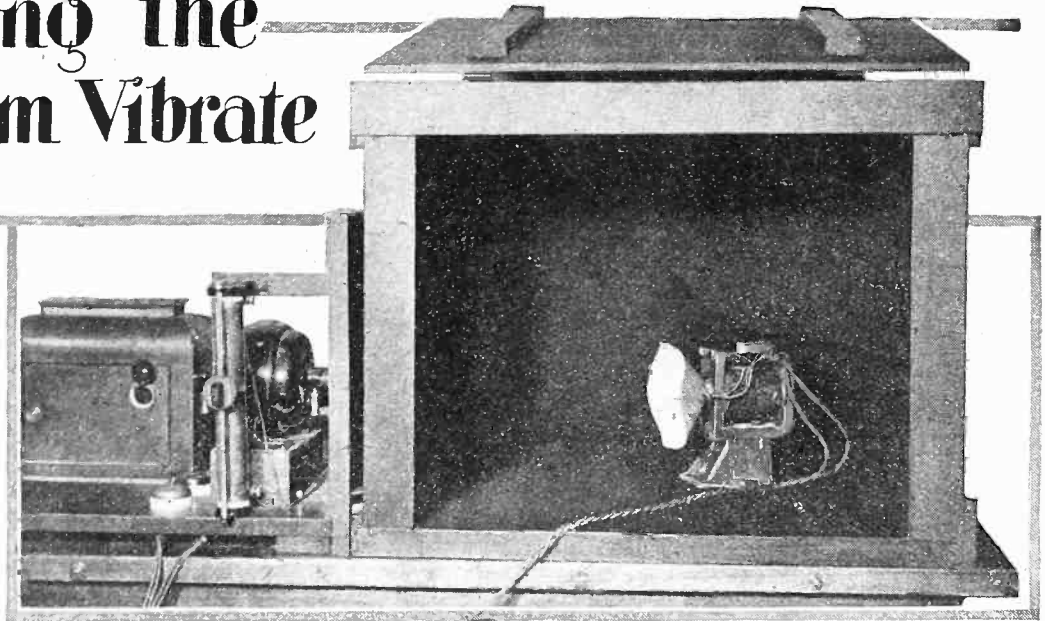

Stroboscopic Examination of Modes of Vibration.

IT is well known that all types of diaphragm possess natural modes of vibration. These are present whatever the shape or pattern of the diaphragm, but the mode of vibration is dependent upon such physical properties of the diaphragm as stiffness, mass, and shape. Readers will be familiar with the vibration patterns which can be shown by means of dust and sand figures and are particularly easy to obtain in the case of flat telephone diaphragms, but this method has its limitations, for, although it is, of course, of extreme interest in the study of the subject, it only serves to show up the nodal lines along which the vibration is a minimum at any particular frequency.

The arrangement for examining loud speaker diaphragms which it is proposed to describe is of rather special interest, because it permits the measurement of the relative amplitudes and phases of the diaphragm.

It is well known that movements can be observed at "slow motion" when illuminated by intermittent light on the stroboscope principle. To observe the vibrations of the diaphragm of, say, a moving-coil speaker, the diaphragm is viewed either through a stroboscopic shutter, or alternatively the diaphragm is illuminated by a beam of light passing through a stroboscopic shutter. The vibrations of the diaphragm can then be seen at "slow motion."

The method is most effective at low frequencies, but useful observations can still be made up to frequencies of the order of 1,000 cycles per second. At higher frequencies the amplitudes become too small, and the vibrations have to be observed with the aid of small pivoted exploring mirrors by the arrangement used by Dr. Kennelly.

The apparatus which was used in the tests described and shown in the title photograph and in Fig. 1 consisted of an ordinary arc lamp employed to project a concentrated beam of light through a slotted disc. This disc was fitted to the spindle of an electric

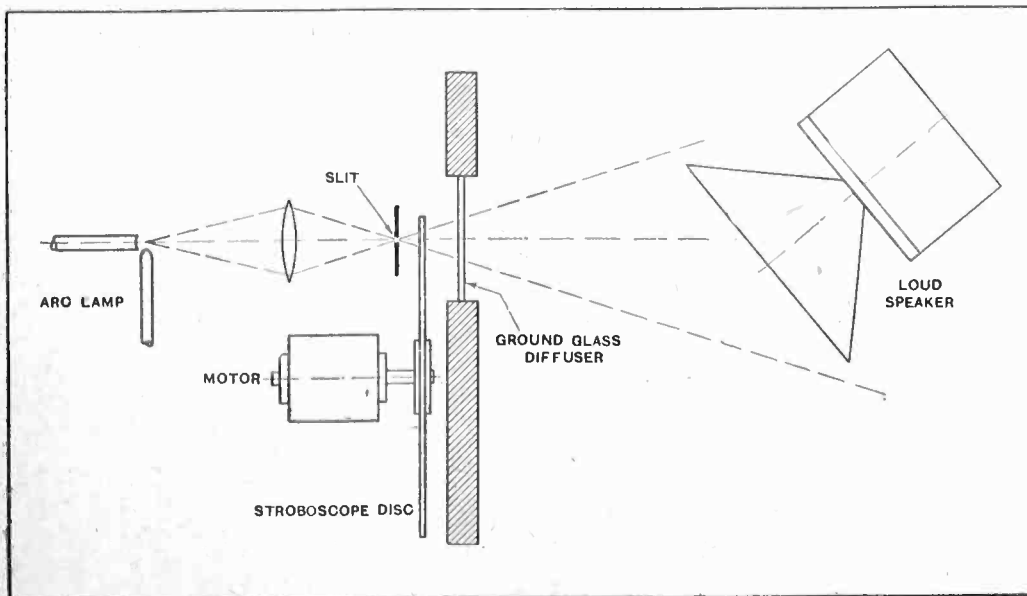

Fig. 1.—Diagram showing method of setting up the apparatus for observing diaphragm vibrations.

Watching the Diaphragm Vibrate.—

motor the speed of which could be controlled within fine limits. The rotating slotted disc served to interrupt the light. It was found convenient to place the speaker which it was intended to examine in a large box about 4ft. square and lined with thick black felt. The purpose of this was in order to have a dead-black background against which the illuminated diaphragm would show up well, and, secondly, the box provided an effective means of absorbing a proportion of the sound emitted from the speaker which became rather annoying to observers when large amplitudes were used.

An Interesting Field for Experiment.

Some interesting experiments have been carried out employing cones of about 7in. in diameter and supported only at the centre to a "moving coil." It can be seen that in this "free edge" condition the diaphragm vibrates as a rigid piston only at low frequencies up to about 50 cycles per second, and on reaching 60 cycles per second the diaphragm vibrates with two nodal diameters as illustrated (Fig. 2). If now we continue to increase the frequency it will be observed that the two nodal diameters become less marked, and if we continue to increase the frequency up to about 100 cycles per second three nodal diameters appear and become definite at about 130 cycles per second. The number of diameters continues to increase with increase in frequency of vibration, and as many as twelve nodal diameters have been observed with this arrangement.

The alternate segments of the nodal figures vibrate in opposite phase, so that there is considerable loss in radiation efficiency taking place under conditions where the dimensions of the segments are small when compared with the wavelength of the sound emitted. This phenomenon is especially striking to the observer when the diaphragm is vibrating at 60 cycles per second and the free edge cone takes the form of two nodal diameters. The maximum amplitude at the edge of the cone may be as much as half an inch, yet the sound

radiation may be scarcely perceptible. The segmental vibration may be suppressed by loading the diaphragm edge with flexible material, such as velvet. If, say, a ring of velvet half an inch wide is glued to the diaphragm edge and clamped at its outer edge to a rigid support, it will then be seen that with this loading of the diaphragm edge it is possible for the cone to vibrate approximately as a rigid piston up to 200 cycles per second. This naturally has the result of increasing the radiation efficiency many times, because the segmental vibration is now suppressed.

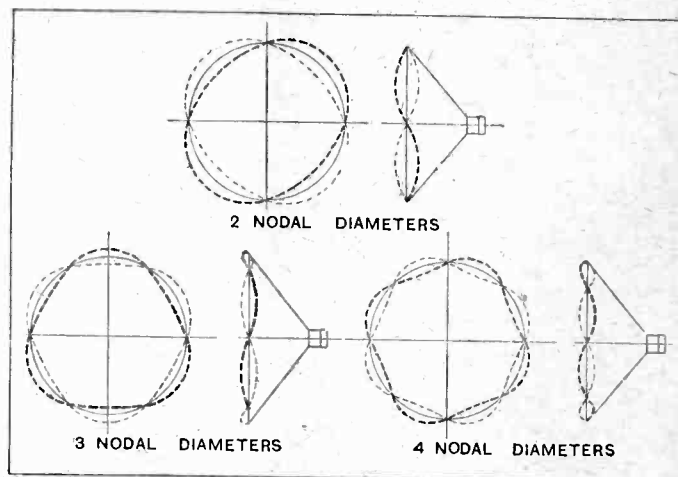

Fig. 2.—Diagram showing nodal diameters produced at various frequencies.

This little experiment is extremely instructive, and it is well worth the while of the amateur and experimenter if he is interested in the study of the action of loud speaker diaphragms to fit up the necessary apparatus to repeat the experiments. Various materials can be employed for the diaphragms, and the effects of different methods of support can be studied. Standard frequency records might be employed if a standard frequency generator is not available to excite the moving coil.

Profusely illustrated, and containing between its covers everything that has any connection, however remote, with wireless and electrical reproduction, is a very brief summary of the 276-page 1930 Wireless and Electrical List issued by Messrs. J. J. Eastick and Sons, Eelex House, 118, Bunhill Row, London, E.C. The first few pages are devoted to valves; then follow 45 pages of illustrations and abridged descriptions of proprietary sets and cabinets, to be followed by a section dealing with eliminators and mains equipment. The following 18 pages contain illustrations and prices of practically every type of loud speaker on the market, then some space is devoted to coils, H.F. and L.F. coupling devices, condensers, fixed and variable, while the last 100 pages deal with meters, switches, and a plethora of sundries too numerous for detailed mention here.

Abbey Radio, 47, Victoria Street, Westminster, London, S.W.1.—Price list and abridged description of "Vatea" radio valves.

**CATALOGUES
RECEIVED.**

The Regent Radio Supply Company, 21, Bartlett's Buildings, Holborn Circus, London, E.C.4.—Illustrated booklet describing the "Regentone" range of D.C. and A.C. battery eliminators designed especially for use in portable sets.

Tannoy Products (formerly the Tulsemere Manufacturing Co.), 1-7, Dalton Street, West Norwood, London, S.E.27.—Descriptive folder dealing with a new "Tannoy" H.T. eliminator, model P.2 for A.C. mains, for use in portable and transportable sets.

Baker's Selhurst Radio, 89, Selhurst Road, South Norwood, London, S.E.25.—36-page handbook illustrating and describing the range of moving-coil loud speakers made by this firm. Many useful hints are included on the use and operation of these loud speakers.

Igranic Electric Co., Ltd., 149, Queen Victoria Street, London, E.C.4.—Descriptive folder dealing with the Igranic "Response Corrector," which has been designed to correct for slight deficiencies in the bass and of the higher frequencies, in gramophone reproduction, by electrical methods.

Pertrix, Ltd., Britannia House, 233, Shaftesbury Avenue, London, W.C.2.—20-page booklet dealing with Pertrix H.T. and L.T. accumulators.

Philips Lamps, Ltd., Philips House, 145, Charing Cross Road, London, W.C.2.—Illustrated booklet describing the Philips gas-filled thermionic rectifying valves.

The Gramophone Co., Ltd., 363, Oxford Street, London, W.1.—Service Manual No. 1: a series of loose-leaf folders describing the fitting and maintenance of the H.M.V. radio gramophone, Model 520. Especially prepared for dealers' service mechanics.

BROADCAST RECEIVERS

REVIEWED

R.I. "Madrigal" MAINS FOUR

A Self-contained Transportable for A.C. Mains, Incorporating a Moving-coil Loud Speaker.

IN external appearance this new production of Radio Instruments, Ltd., is similar to the "All Electric S.G. Three," reviewed in the issue of this journal dated August 21st, 1929. The circuit, however, has been completely revised and the range extended by the inclusion of *two* stages of H.F. amplification with indirectly-heated screen grid valves. With two H.F. stages there is an additional tuned circuit, and this has resulted in improved selectivity.

The tuning inductances are of the binocular astatic type to assist the efficient screening system in preventing coupling between the H.F. circuits. With high-efficiency screen-grid valves careful design is necessary if stability is to be assured, and every possible precaution must be taken to remove the last traces of inter-stage coupling.

The three main tuning condensers are ganged and occupy a sub-divided screening compartment running from back to front of the set. The circuits are balanced by trimming condensers, which are adjusted at the works, but an additional trimming condenser is connected across the first tuned circuit for the purpose of compensating for the change of capacity when an external aerial is connected. This condenser is operated by an ebonite extension rod, projecting through the

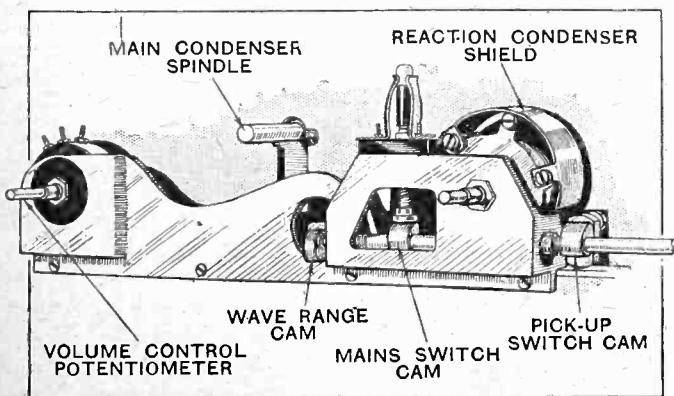

Centralised switch gear operated by cams on a common spindle.

A 19



Two H.F. Stages with Indirectly Heated S.G. Valves.

screening plate under the lid of the cabinet. The aerial is coupled through a small fixed condenser.

The H.F. couplings consist of tuned-grid circuits with choke feeds from the H.F. valve anodes, and the change over from long to short waves is effected by short-circuiting a section of each tuning inductance.

A variable potentiometer supplies the screen-grid potential to the H.F. valves, and thus serves as a radio volume control. By a well-thought-out switching system the same resistance is used as a volume control for the gramophone pick-up, for which terminals are provided on the back of the set.

The Detector Stage.

The detector valve (AC/HL) is arranged as a leaky grid rectifier, a small positive bias being derived from the bottom end of the screen-grid potentiometer. When switched over for gramophone reproduction the necessary negative bias is provided by a resistance in series with the cathode. A similar arrangement is used for providing grid bias in the case of the two H.F. valves and the power output valve. In order to prevent damping due to grid current the detector valve is tapped across approximately one half of the tuned circuit immediately preceding. The method of tapping takes the form of a capacity potentiometer with one condenser fixed and the other variable, so that adjustment of the tapping point to the optimum value is possible. Further, this method simplifies switching, as the tapping point remains the same for both long and short waves.

The detector stage also incorporates reaction, which is capacity controlled. The detuning effect of variable reaction has been eliminated by connecting a swamping capacity across part of the reaction coil.

A single stage of L.F. amplification follows the detector, the valve being an AC/P. It is coupled to the detector by an R.I. "Hypermu" transformer, and a resistance is inserted between the grid and the secondary winding to suppress any H.F. currents remaining

R.I. "Madrigal" Mains Four.—

after the detector stage. The output to the loud speaker is made through a choke-capacity coupling, the choke employed being the new "Hypercore," rated at 50 milliamps.

An aluminium casting at the front of the chassis houses an ingenious cam switch by means of which all the subsidiary controls are operated by a single knob let into the right-hand side of the cabinet. One cam operates the wave-range switches running through the condenser compartments, another switches in the pick-up terminals and changes over the volume control, while a third works the on-off switch in the primary of the mains transformer.

The top of the screening boxes is covered by a copper lid through which the tops of the valves project. Above this is an earthed aluminium plate which prevents stray capacity coupling between the anodes of the screen-grid valves.

Actually the earth connection is made to the centre point of the mains transformer primary through a centre-tapped condenser, and the grid of the first H.F. valve is also at earth potential as far as radio-frequencies are concerned. The valve cathodes, the whole of the screening system, the loud speaker leads, etc., therefore act as a minute aerial. The arrangement is unconventional, but appears to work satisfactorily in practice, as the H.F. amplification is adequate to deal with the minute pick-up available. The fact that hand capacity effects are negligible may be taken as evidence that the H.F. potential of the screens above earth is small and the pick-up correspondingly minute.

Bearing in mind this circumstance, the manufacturers may be congratulated on the performance of the set without an external aerial. In addition to the two Brookmans Park transmissions and 5GB, six foreign stations were received on the medium-wave range after dark at good programme strength, Turin and Rome being outstandingly good. It is difficult to give figures for selectivity, but as a rough guide it was noted that 5GB occupied a band of about 5 degrees on the 100-degree dial and London Regional 15 degrees at a distance of five miles from Brookmans Park. Incidentally, the production models will be calibrated in wavelengths, and the dial illuminated by a pilot lamp. Selectivity may be increased by turning down the volume control and increasing reaction. The volume control varies the screen-grid

potential of the H.F. valves, and when this is decreased the impedance of the valves is raised, giving less loading of the tuned circuits and increased selectivity.

The long-wave range can be relied upon to produce six or seven stable programmes, either in daylight or after dark. The selectivity on this range is more than sufficient to separate 5XX from Radio Paris, but a slight background from Daventry could not be eliminated when receiving Königswusterhausen in North London. In the particular model tested, only about two-thirds of the volume control could be usefully employed, as the top section of the dial produced too high a screen-grid voltage for stability. However, a good minimum was obtained, and the principle of volume control adopted is justified, since it gives considerable latitude for variations in the characteristics of the screen-grid valves.

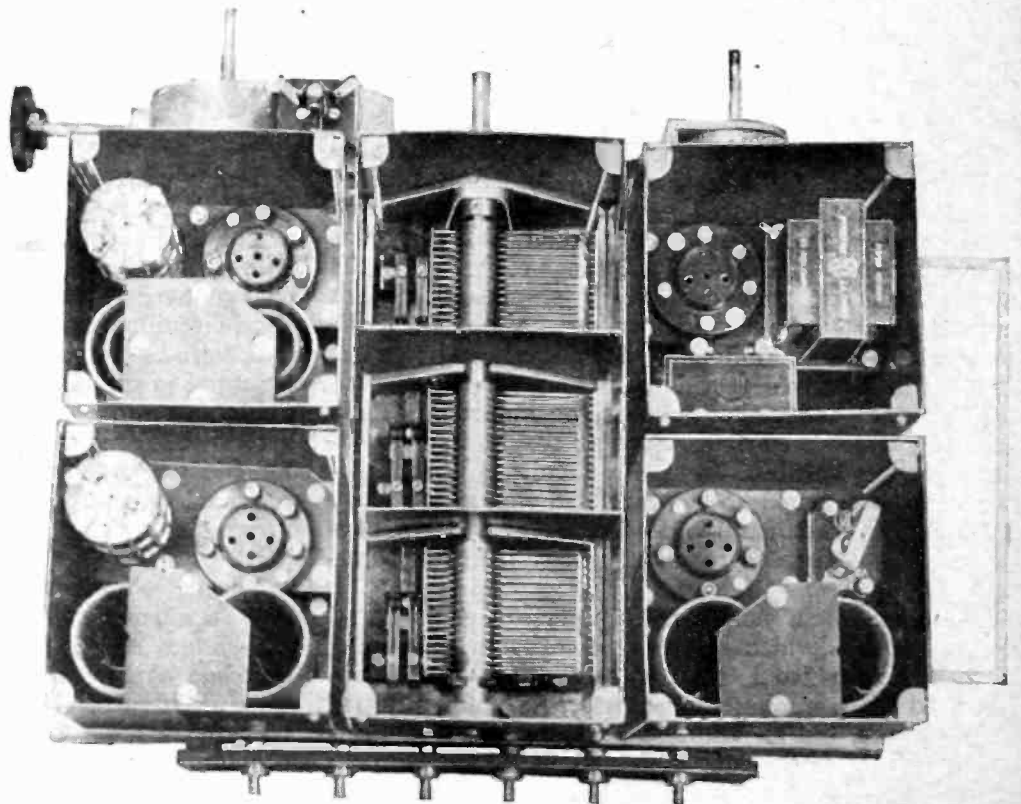

Plan view of the screening compartments; first H.F., bottom right; second H.F., bottom left; detector, top left; output stage, top right.

The receiver is mounted on a pedestal running on rubber-tyred castors, which contains a Peter Grassman moving-coil loud speaker, complete with rectifier for energising the field winding. The quality of reproduction from this speaker is distinctly above the average, and precise measurements would be necessary to detect any faults which might exist; they are certainly not appreciable to the ear.

The cabinet work is of a high standard, the normal finish being in burr walnut with quartered panelling, and the price of the complete instrument, including loud speaker, is £58 18s. The price of the set alone is £40.

The makers' new address is Radio Instruments, Ltd., Madrigal Works, Purley Way, Croydon.

WIRELESS THEORY SIMPLIFIED



By S. O. PEARSON,
B.Sc., A.M.I.E.E.

(Continued from page 68 of previous issue.)

THE THREE-ELECTRODE VALVE.

AS early as 1907 Lee de Forest of America interposed between the filament and anode of Fleming's valve a metal grid or mesh with the object of controlling the stream of electrons passing from the hot filament to the plate, thus inventing the three-electrode valve or triode. He realised that the free electrons representing the space charge in the gap between the plate and filament produced an electric field which exercised a considerable controlling effect on the current passing, and that if this field could be altered in strength at will by superimposing on it another field under complete control, the current might be varied as desired.

The third electrode or grid was therefore placed close to the filament where the normal space charge is most intense, and by applying different potentials to the grid the space charge could be counteracted to varying degrees. By this means it was found that the plate current could be controlled over the whole range from zero to the saturation value represented by the maximum possible emission from the filament. The third electrode must necessarily be in the form of an open grid or mesh so that the electrons issuing from the filament can pass through the interstices and reach the plate.

The simplest type of three-electrode valve is one in which a straight filament lies along the central axis of a cylindrical anode or "plate" (some of the earliest valves had flat anodes, hence the name "plate," which is still used to a large extent no matter what the shape of the anode might be). The grid consists of an open helix or spiral of wire surrounding the filament and also centrally arranged with respect to it. An arrangement of this description is shown in Fig. 1 (A). As the characteristics of a valve depend to a very large extent on the geometrical arrangement of the electrodes a great variety of designs is to be found among modern valves. For instance, one important class employs, instead of a single straight filament, an inverted "V" or an "M" shaped one enclosed by a flat-shaped anode and grid, an example being shown in Fig. 1 (B).

or an "M" shaped one enclosed by a flat-shaped anode and grid, an example being shown in Fig. 1 (B).

General Properties of the Triode.

When the filament is heated and a moderately high positive potential is applied to the anode by connecting a suitable battery between the anode and the filament, electrons emitted from the latter are attracted across the vacuous space and pass through the openings in the grid on their way to the anode. The intensity of the electric field in the vicinity of the grid depends not only on the number of free electrons in that space, but also on the potential of the grid relative to that of the filament. Since the potential of the filament itself is not the same at all points along its length owing to the potential difference applied to its ends for heating purposes, it is usual to refer the potentials of all other electrodes to the negative end of the filament. Where the cathode is independently heated by a separate heating element as in A.C. valves, all points of the cathode are at the same potential and the above stipulation is not necessary.

For a given valve the anode current, represented by the electrons getting through to the plate, depends on the anode voltage or plate potential and on the voltage of the grid relative to that of the filament, provided of course that the maximum or saturation current has not been reached. The general performance of a valve can be fairly accurately determined from curves showing the relationship between the anode current and voltage with a fixed value of grid potential (usually zero) and between the anode current and grid potential with a fixed value of anode voltage, the filament or heater voltage being maintained constant at the normal rated value. Such curves are referred to as the static characteristic curves of the valve, the term "static" being used because the various voltages and currents are constant when the readings are taken.

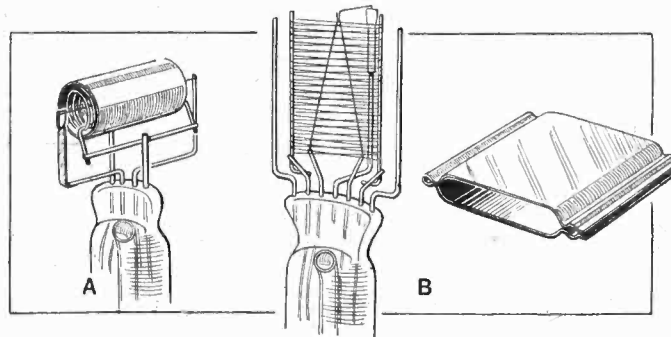

Fig. 1.—Simple types of three-electrode valve. (A) Straight filament and cylindrical anode. (B) V-type filament and flattened anode.

Wireless Theory Simplified.—

Circuit for Obtaining Valve Characteristics.

A suitable circuit for determining experimentally the static characteristics of an ordinary three-electrode valve of the filament type is given in Fig. 2. The filament is heated by a "low-tension" battery A, preferably a lead accumulator, and the anode is maintained at the required positive potential by means of a "high-tension" battery B, capable of supplying a current somewhat greater than the saturation current of the valve. The terms "low tension" and "high tension" are applied to the batteries A and B respectively because A is a low-voltage battery for filament heating only (2, 4 or 6 volts), and B is a comparatively high voltage battery giving 50

volts or more according to the requirements of the valve to be tested, but capable of supplying a few milliamps of current only.

A variable resistance or "filament rheostat" R is included in the filament circuit to enable the voltage to be adjusted to the correct value with the aid of the low-reading voltmeter V_f . A high-reading high-resistance voltmeter V_a is connected between the negative end of the high-tension battery and

the positive tapping point which leads off to the anode of the valve. This voltmeter must have a high resistance in order not to cause an undue heavy drain of current from the high-tension battery. A suitable voltmeter is one with a resistance of 200 ohms per volt, and would take 5 milliamps only, when reading maximum voltage. The milliammeter mA. must be connected in the position shown and not at X, where it would read the sum of the currents taken by the valve and the voltmeter V_a .

Now as regards the grid circuit: It is necessary to be able to vary the grid voltage through a suitable range from several volts positive to several volts negative with respect to the negative end of the filament. This can best be accomplished by joining the mid point of a battery C to the negative "leg" of the filament and by connecting a high-resistance potentiometer P across the ends of this battery. The grid of the valve is then connected to the slider of the potentiometer with a microammeter μA in circuit for indicating any current which may flow to the grid. The potential of the grid with respect to the negative end of the filament is measured by the voltmeter V_g .

Obtaining the Anode Voltage/Anode Current Characteristic.

In conducting the measurements, the first step is to adjust the filament voltage V_f to the correct value by means of the resistance R. To obtain the curve of anode current plotted against anode voltage with the grid maintained at zero potential either adjust the

slider on the potentiometer P until V_g reads zero, or, better still, remove the grid battery C and the potentiometer temporarily and connect the grid directly to the negative end of the filament. Then take readings of V_a and mA. for various tapping points X on the high-tension battery B.

On plotting the curve it will be found to be very similar in shape to the characteristic curve of a diode or valve without a grid, but the actual values of the anode current will, of course, not be the same with the grid present as without it, even though the dimensions of the filament and plate are the same in each case. A typical curve obtained in this way for what is termed a "general purpose" valve is given in Fig. 3,

the grid having been joined permanently to the negative end of the filament during the time of making measurements.

It will be noted that the slope of the curve at first increases as the anode voltage is raised from zero, but that over the middle range the curve is almost straight, the slope being nearly constant. Near the top the slope becomes less steep again until, when the saturation current is reached, the curve becomes horizontal.

It will be shown subsequently that the slope of the curve over the straight part yields very important information regarding the resistance of the valve.

Plate to Filament Resistance.

The whole of the power coming from the high-tension battery B in Fig. 2 is expended within the valve because there is supposed to be no resistance in the external anode circuit. For instance, if I_a is the anode current indicated by the milliammeter mA., and V_a the voltage between the anode and the filament, the power given to the valve is $V_a I_a$ watts, and is expended inside the bulb. The energy represented is converted into heat in the valve and, therefore, in effect, the valve possesses internal resistance between the filament and the plate, because, according to the laws of ordinary circuits, heat can only be produced by a current when resistance is present. But the space between the filament and plate is a vacuum, and a vacuum has infinite resistance; it cannot conduct any current whatever. The electrons come across free in space, and, therefore, *no heat can be generated in the space between the anode and the filament or cathode.*

It is clear, then, that our ideas of resistance as applied to material conductors cannot be applied in the case of a valve. We know that something equivalent to resistance is present because energy is absorbed from the high-tension battery and converted into heat which raises the temperature of the anode itself. When the anode voltage is raised sufficiently the anode becomes red-hot in many valves. We shall see later that

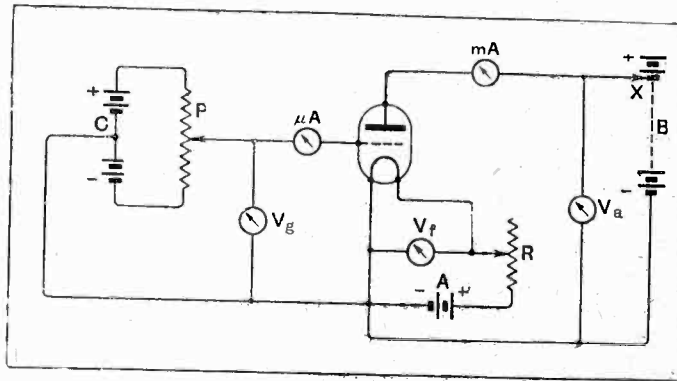

Fig. 2.—Circuit diagram for determining the static characteristics of a three-electrode valve. The positions of the instruments in the circuit should be as shown, so that the voltmeter currents do not affect the readings of the milliammeters.

Wireless Theory Simplified.—

the equivalent internal filament to anode resistance of the valve usually amounts to some thousands of ohms, and a high resistance of this order cannot possibly exist in the metal of the plate itself. The first questions to be settled then are how the heat is generated, and how it comes to be accumulated on the anode.

The electrons which leave the hot filament would never reach the anode if the latter were not given a positive potential; it is this positive potential which accelerates the freed electrons and draws them on towards the anode. Now, as already mentioned in a previous section, in spite of its infra-microscopic dimensions (if it has dimensions at all), an electron is known to possess a certain amount of mass or inertia, that is to say, a force is necessary to increase its velocity or accelerate it, just as a force is necessary to set a material body in motion. When a body is accelerated or set in motion a certain amount of energy is expended during the process, and this energy is stored in the moving body. Energy in this form is known as kinetic energy, or, in other words, energy of motion; it is proportional to the mass of the body and to the square of the velocity.

Thus in our valve the energy coming in from the H.T. battery is directly employed in accelerating the electrons emitted from the filament, and is stored as kinetic energy in the moving electrons crossing the vacuum. As yet there is no generation of heat—merely the production of motion. By the time the electrons reach the plate they have acquired an enormously high velocity which can be calculated in terms of the voltage. They collide violently with, and are brought to rest by, the anode itself, and in so do-

ing give up their kinetic energy which is converted into heat at the anode, resulting in a rise of temperature.

The principle can be roughly illustrated by an armour-piercing shell fired from a gun, the energy required for penetrating the armour being carried as kinetic energy by the high-velocity shell. When the latter strikes the armour there is a great generation of heat, causing a temperature rise sometimes high enough to cause localised melting of the steel.

We can conclude then that the heating which occurs at the anode of a valve is *not due to resistance at all*, but that it is simply the result of the collision of countless numbers of high-velocity electrons with the anode. The energy taken from the battery is first given to the electrons in overcoming their inertia, or *mechanical resistance*, to motion as they are accelerated, and then as each electron strikes the plate it gives up its kinetic energy which is there and then converted into heat.

If the anode voltage is very high the electrons strike the plate with extremely great velocity, and the molecules at the surface being bombarded may be so violently agitated that they themselves throw off electrons again with sufficiently high velocity to drive them back to the filament, thereby reducing the anode current. This is known as secondary emission.

Knowing how the heat is generated in the valve; that it is not due to resistance as ordinarily defined, we are now in a better position to interpret clearly the meaning of the anode voltage/anode current curve of Fig. 3 in relation to the equivalent internal resistance of the valve.

(To be continued.)

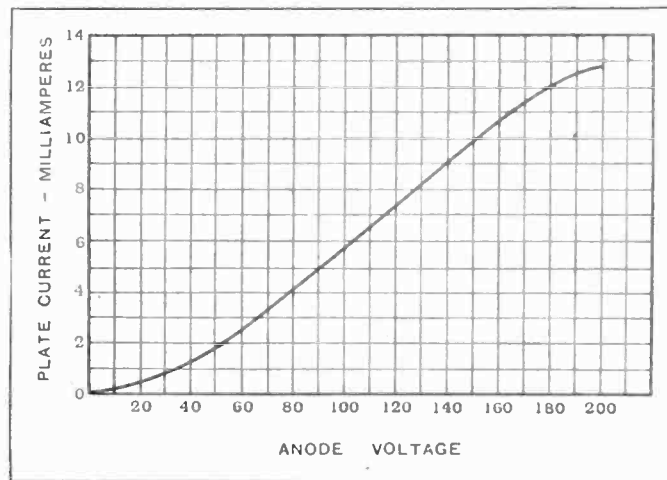

Fig. 3.—Anode voltage/anode current characteristic of a general purpose valve taken with the grid potential set at zero.

CORRESPONDENCE.

The Editor does not hold himself responsible for the opinions of his correspondents.

Correspondence should be addressed to the Editor, "The Wireless World," Dorset House, Tudor Street, E.C. 4, and must be accompanied by the writer's name and address.

RADIO SERVICING.

Sir,—With reference to the letter from Mr. R. V. Jones published recently, I suggest that he, like a good many more, buys his radio goods where prices are cut. In this case he cannot expect service. If, on the other hand, he has always paid full price, and not obtained service, then I say without hesitation that his knowledge of the radio retailer is extremely small.

A friend of mine the other day asked me to look at a Marconi-phone portable which he had purchased that afternoon. It refused to function. I asked him where he had purchased it, and he said a music dealer. This particular music dealer sells portables but has no experience of radio, and it is a common practice of his to hand out sets with run-down batteries, etc., not really knowing how a portable functions and that batteries are necessary. I fancy he thinks they are like gramophones—want

winding. If the public will not patronise proper radio shops who do not cut prices, then I cannot see how they can logically expect service. The proper radio shop is, I agree, in the minority, but, as manufacturers in general take no steps to prevent price-cutting, and as price-cutting with service does not pay, then, *ipso facto*, the man who expects something for nothing cannot expect service.

B. GLADSTONE.
London, S.W.

Sir,—I am interested in the letters appearing in your correspondence columns *re* "Radio Service."

I should like to suggest, as a fact, that the radio retailer, taking the average, has to cut prices to do a fair trade, and that this brings customers who could not otherwise afford wireless. Service is not possible under such conditions.

I think that the largest sales were made by the big adver-

tising of valve manufacturers in 1928-29; this gave an impetus to the whole trade.

Mr. A. Dunnett is not concerned with the wireless trade as a whole, and this is the point that matters; moreover, to attempt to gain knowledge of the customer's requirements when he knows not what they are, and to weigh the *pros* and *cons* of what is best for the intending customer, is almost certain to cause him to suspect lack of knowledge. The man who knows little or nothing about wireless is the best salesman for the general public.

Every statement made by Mr. Dyer, of the Wireless Retailers' Association, I regard as correct, and as a true statement of things as they are.

As mentioned in the first part of this letter, things could be made to "hum" again with big advertising. The retailer who can "service" will not put radio on its legs.

London, S.E.11.

G. A. RYALL.

Sir,—Mr. R. V. Jones's statement in your issue of the 9th inst., that members of the W.R.A. should be compelled to pass a qualifying examination, seems a little unnecessary.

As Mr. Jones no doubt realises, the theory and practice of radio cannot be learnt in a week or two to reach an examination standard, and how many dealers can spare a lengthy period to concentrated study for an examination, granting that they need it, as Mr. Jones implies?

The average dealer has sufficient radio knowledge to enable him to diagnose faults in home-built receivers, but with the factory-built receivers the question is usually much different, owing to the less open construction of the set.

It is on the commercial set that the dealer needs instruction as to its construction and performance, including rectification of possible breakdowns.

The Marconiphone Company is leading the way to the solution of this problem, and complete satisfaction of the buyer of a radio receiver is not only instructing the dealer in the construction of their receivers and diagnosing faults, but how and why the various components function.

Such a system of training is bound, not only to lead to a strong group of efficient radio retailers, but also to a satisfied public who will go to its dealer with the same confidence as it visits its doctor.

C. ALEXANDER HOWARD.

INTERFERENCE WITH THE RECEPTION OF RADIO.

Sir,—The subject named has been one of much controversy, but I feel that the time has arrived when steps should be taken so that the matter may be dealt with on the same lines and under the same statute as other nuisances.

At the moment the position is as set out in a letter before me from "The Engineer in Chief" of the G.P.O.

"I am directed by the Postmaster-General to say that he has no statutory powers under which he could compel the owner of electrical plant causing interference with wireless reception to remove the cause of the interference."

Now I do not profess any legal knowledge, but speaking as a layman I must say this does seem to represent a remarkable state of affairs. I myself am particularly interested in the reception of programmes which, as far as I am aware, do not entail any expense on the part of our Post Office beyond the cost of issuing a licence, and yet, having received the licence fee, they admit they cannot take such steps to deal with interference as would enable me to receive that for which I have taken out a licence to receive. I am aware that a gun licence does not carry with it the provision of birds to shoot, but the two cases are not parallel. The matter could be argued under the heading of "causing a nuisance" because, should my neighbour install, say, a petrol electric plant, the exhaust from which caused annoyance, I could obtain an injunction to refrain him from continuing the annoyance, but, say, in the case of a badly sparking commutator, which would prevent or interfere with wireless reception, I am powerless to prevent it.

One could quote cases *ad lib.*, but my object in writing is not necessarily to start a controversy, but rather so that those interested in the matter can think out collectively or individually what steps may be taken to deal with the situation. Wireless reception has become part of our daily life, and, sooner or later, there must be legislation to deal with such matters as

needless interference. I believe it would help in the meantime if those interested would take the matter up direct with whoever may be their Member of Parliament.

This would at least help by indicating the feeling of the listening public and prepare the ground for such time as the case may be mentioned in the House.

JAMES NELSON, M.I.E.E.,
Institute of Wireless Technology.

71, Kingsway, W.C.2.

Sir,—On page 25 of *The Wireless World* of July 2nd, mention is made of C. E. Board's 132,000-volt supply, and possible interference. In September last I built the "Foreign Listener's Four," and as was to be expected the results were all that one could wish for. I am situated midway between two towers carrying the 132,000-volt lines between Glasgow and Bonnybridge on the Glasgow-Edinburgh line. This section was energised 14 months ago (May, 1929), and from then till September, 1929, I was using a Det. 2LF set and experienced no trouble. When using my "Foreign Listener's Four," the interference from the overhead lines on wet or foggy nights is so bad as to completely wipe out or distort all stations other than the Local (5SC), which is only received at 50 per cent. normal strength, and accompanied by a machine-gun rattle. The noise from the towers reminds one of the preparation of the Sunday morning's eggs and bacon. I have been in touch with others who use a H.F. Det. 2LF set and they complain of the same trouble, but those with Det. 2LF sets do not experience the trouble to the same extent. On a dark and moist night the insulators from a distance of 100 yards appear illuminated, the sparking and crackling over the insulators being heard clearly at that distance.

A. CAMERON.

Glenboig, Lanarkshire.

DUPLICATING 5XX.

Sir,—Until quite recently I resided at Bournemouth, and, in common with Mr. Lucas, I agree that 5XX is THE only station which can be relied on for really consistent reception. I notice he states he has never had the good fortune to hear the local station. I am inclined to query his good fortune if my experience is anything to go by. At one time I lived within a quarter of a mile of 6B.M., and, of course, there I was absolutely swamped. BUT the output at times was appalling. Signal strength varied enormously, and when at times gramophone records were "put over" from the local studio the quality was comparable with an ancient phonograph.

Now take the case of a friend of mine living at Swanage. His is a three-valve set, S.G., det. and pentode. Here 5XX is THE only station on the British side one can listen to with any degree of certainty; 5GB is utterly useless as an alternative. Fading is terrible. Brookmans Park is the same. Of course, Bournemouth comes in with a thump, being only eight miles away. But quality and consistency is lacking. Tune up to 5XX, however, and he comes through night and day, never varying. How about an alternative programme, though? One must go over to France for that. All the French stations come in admirably, particularly Toulouse. I can assure the B.B.C. that, were they to duplicate 5XX, they would earn the gratitude of all the people who at present rely *entirely* on that station for their British reception. I would ask them: Why must South Coast dwellers look to foreign countries for their alternative programmes?

L. J. DAVIS.

London, S.W.15.

MIDLAND REGIONAL WAVELENGTH.

Sir,—I read with amazement in your issue of July 2nd, under "Broadcast Brevities," that the B.B.C. intend to move the Midland Regional down to 377 metres. As one can only just receive Toulouse in the London area without interference from the London Regional station, what is to be the position when we attempt to receive the Midland Regional Station upon its proposed new wavelength? The B.B.C. has blotted out Cologne, Nurnburg, practically Turin, and now Toulouse will be impossible. Why do they not settle down on Rome's doorstep and then discontinue the publication of *World Radio*?

Highgate, N.6.

G. F. H.

Dissatisfaction in Aberdeen.

The number of licences in the city of Aberdeen is diminishing as many listeners complain that, since their local station is now little more than a relay station taking its programmes from London, the Scottish quality has disappeared. Many users of crystal sets have allowed their licences to lapse, and the number of listeners is stated to have dropped by over 1,400 since last September. Mediocre London vaudeville is considered a poor recompense for the loss of the rich Scottish humour they used to get, and the Aberdonians say that it is no good a Londoner selecting a programme for Scottish audiences.

Mr. Lewis' New Duties.

Though Mr. Joseph Lewis, the musical director of the Birmingham Studio orchestra, has now joined the headquarters staff at Savoy Hill, I understand that he has not entirely forsaken Birmingham. His present position is that of a consultant in matters concerning musical programmes and assistant to Dr. Adrian Boult as a conductor. He will probably travel frequently between the two cities, conducting sometimes in London and sometimes in Birmingham.

Another Woman Announcer.

The Birmingham studio, incidentally, has followed the example of other provincial stations in appointing a woman announcer. Last week Miss G. Ward, a member of the studio staff, went through her first ordeal in this capacity during Miss Josephine Tucker's broadcast, when she announced the titles of that artiste's songs. Miss Ward will probably fill the duties of announcer at week-ends and as a holiday relief.

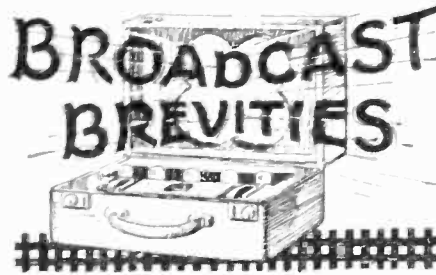

By Our Special Correspondent.

Manchester has had a woman announcer at intervals for some considerable time, but there is no indication at present that Savoy Hill intends following suit.

Announcing Made Easier.

Announcing nowadays is far more cut-and-dried than in the earlier days of broadcasting, and does not call for the same initiative and ability to cope with any emergency that was required in times past, in fact, announcers are now invariably furnished, as a matter of routine, with a written copy of everything they have to say.

Scottish Regional Station.

In spite of the regular daily rumours that the B.B.C. has decided upon a site for the Scottish Regional Station it is by no means certain that the necessary conditions will be met with in the site at Falkirk, which has been so frequently mentioned.

The test holes which have been dug have not yet revealed that the soil will be suitable for a broadcast transmitter; one boring has disclosed a subsoil composed of

a mixture of clay and gravel, while another has shown pure sand, whereas the soil required should be either solid clay or unmixed gravel, it will, therefore, be necessary to dig further holes to ascertain whether the mixtures found are merely pockets, or representative of the whole site tentatively chosen.

An Entomological Surprise Item.

Savoy Hill has had many strange visitors, but even stranger than the mosquitos which were broadcast some two years ago were the cicadas which Mr. Hugh Wain brought to a studio the other night as a surprise item. These "winged chirping insects"—to quote the definition given in the smaller Oxford Dictionary—now share the pride of place with dogs, sea lions, and serpents, but perhaps none are so realistic as the cylinder of compressed air used by Victor Hely-Hutchinson in his orchestral music for Karel Kapek's R.U.R.

Zoological Studios.

Some years ago the B.B.C. conceived the idea of broadcasting the roar of a real lion from the studio, and arrangements were made accordingly, but the initial difficulty of getting the king of beasts into the studio had been overlooked, and this item of the programme had to be abandoned. I do not know whether the architects are making any special provision for extraordinary surprise items in their plans for Broadcasting House, but understand that in the new building to be erected in New York there is to be a specially large lift—elevator I should say—capable of conveying an elephant to the studio if his services should be required.

The Birthplace of Mozart.

During August three relays of Mozart's music from his native town of Salzburg will be undertaken. On August 7th his Serenade will be heard by British listeners, on August 20th the first act of "Iphigenie" will be transmitted, and on August 30th an orchestral concert. This will be the longest line relay yet undertaken from the Continent, as the route via Stuttgart to London involves 1,700 miles of line, and at intervals no fewer than 21 repeaters will be installed to provide good quality in the transmission.

Radio Drama for the Midlands.

Is Radio Drama making the progress that was expected of it? The anxiety expressed by Mr. Percy Edgar, director of the Midland Region, regarding the dearth of plays suitable for broadcasting is, no doubt, pretty generally felt in other centres. Mr. Edgar has issued an invitation to play writers to submit plays which are likely to appeal to Midland audiences. "Plays in dialect," he says, "will be considered, but they must be short and must have definite local interest." What is required is to arouse interest by the spoken work alone in the presentation of situations, and attention should be given to the creation of thrilling melodramatic incidents while subtlety which can only be fully brought out by action and gesture should obviously be avoided.

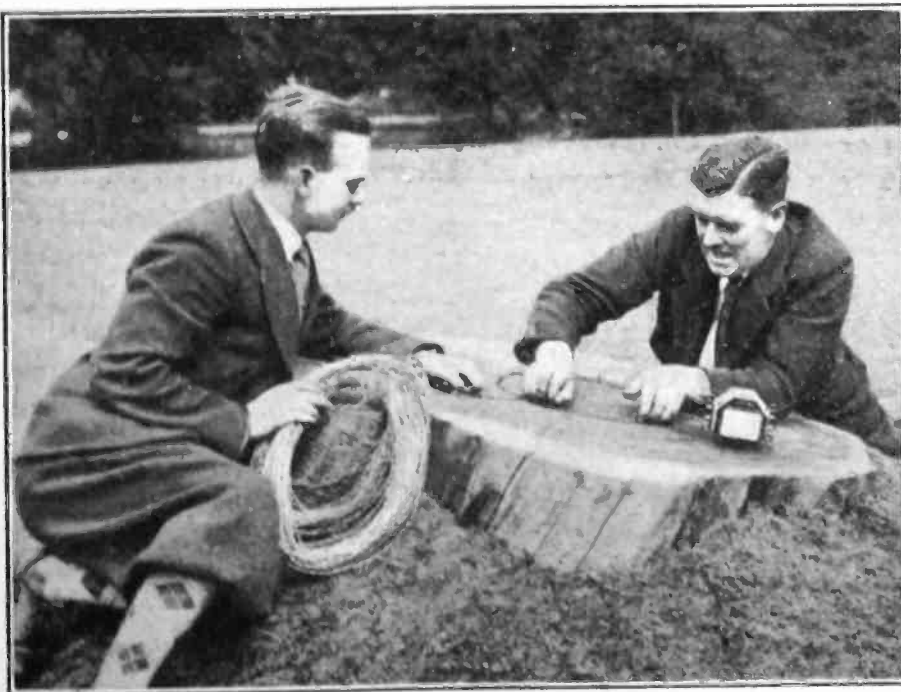

CAMOUFLAGING THE MICROPHONE. To give listeners the impression of being actually among the 6,000 performers during the presentation of the Warwick Pageant the microphone was concealed within the false centre of a large tree stump.

READERS' PROBLEMS.

"The Wireless World" Supplies a Free Service of Technical Information.

The Service is subject to the rules of the Department, which are printed below; these must be strictly enforced, in the interest of readers themselves. A selection of queries of general interest is dealt with below, in some cases at greater length than would be possible in a letter.

A "Gassy Valve.

I have just noticed that there is a distinct blue glow, apparently between grid and filament, of one of my valves. This, I suppose, is an indication of softness. Do you recommend that the valve should be replaced?

D. N. J.

You would, we think, be well advised to change this valve, as "softness" is undesirable for several reasons. A valve in this condition is in any case likely to consume an unnecessarily high value of current from the source of H.T. supply; if used as an H.F. amplifier, it will be responsible for a certain amount of unnecessary loading of the preceding tuned circuit. If the valve operates as an L.F. amplifier, distortion will inevitably be produced.

Pentodes on Short Waves.

Is there any reason why a pentode should not be used as an output valve in a receiver intended solely for the reception of the ultra-short waves? My object in proposing to use one is to obtain rather more L.F. magnification than is afforded by the usual single-stage amplifier with a triode output valve.

W. G.

A pentode works quite satisfactorily in a short-wave set, and was, indeed, used in the S.G. Short-Wave III, described in *The Wireless World* of January 1st. No special precautions need be taken.

A Mysterious Click.

I have for some time been puzzled by the fact that a distinct click in the loud speaker is produced when the H.T. battery of my portable receiver (H.F.-det.-pentode) is connected, even if the filaments are switched off. The loud speaker is directly in series with the anode, and it seems to me that this click must indicate poor insulation somewhere, as I can see no normal path for current when the valve filament is cold. Careful tests have been made, but I am unable to locate any fault, and the insulation of the output valve-holder, which would naturally be suspected, appears to be perfect everywhere.

Do you think that the click is an indication of some minor fault, and, if so, will you please make a suggestion as to where I should look for it?

D. W. S.

We do not think that your receiver is at fault. In a portable set, particularly when a pentode valve is used, it is quite usual to connect a by-pass condenser of sometimes as much as 0.005 mfd. in the

output valve anode circuit: to restrict the passage of stray H.F. currents through the loud speaker leads, etc., this condenser is generally joined directly between plate and filament. If this arrangement is included in your own set the completion of the H.T. battery circuit will have the effect of charging up the by-pass condenser; the charging current must of necessity flow through the loud speaker windings (see Fig. 1), and will produce a click.

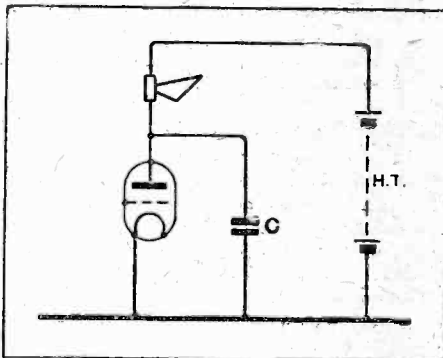

Fig. 1.—Charging current for the by-pass condenser C flows through the loud speaker windings.

If an examination of your receiver shows that our assumption is incorrect, and that there is no by-pass condenser, please write to us again, sending, if possible, a complete circuit diagram.

The Dual Unit Loud Speaker.

In the article describing a double-cone loud speaker in "The Wireless World" of June 18th I can see no mention of the make of cone chassis which carries the Ediswan unit. Will you please tell me the name of the make of the chassis actually used in the instrument as described?

M. L. C.

A standard Ormond chassis was used in conjunction with the Ediswan drive unit.

Insoluble.

I have a 50-volt house-lighting plant, and am thinking of using this source of supply for heating the filaments of my valves, interposing a suitable resistance for "breaking down" the voltage. Will you please tell me the correct value for this resistance? Six-volt valves are used.

B. W. P.

To answer this question, it is essential for us to know the current consumed by the valves at their rated voltage. You do not give us this information, but you can,

however, easily calculate the value of the necessary resistance (in ohms) by dividing 44 by the value of this current, expressed in amperes.

o o o o

True Readings of Eliminator Voltages.

Although it has been stated in your journal that a voltmeter when used for measuring the output of an eliminator can only give an approximately true reading when the current consumed by it is very small in comparison with that normally passing in the circuit across which it is connected, I believe that I am right in saying that under certain conditions the meter can give an absolutely true reading (provided, of course, that it is accurate). If the meter remains connected in position, is it not a fact that it should register accurately the true voltage existing between the points across which it is joined?

A. S. T.

Yes, this is quite correct; the voltage as indicated by the voltmeter will be correct under these conditions, but will be subject to a change of unknown magnitude when the load imposed by the instrument is removed. Of course, this change can be avoided by connecting in place of the meter a resistance having exactly the same ohmic value as its windings.

o o o o

Heating Batteries.

Is it likely that any serious difficulty would be encountered in modifying the Band Pass Four receiver in order that the heaters of the valves could be fed from an accumulator? It is proposed to use D.C. mains in conjunction with a small accumulator battery for H.T. supply.

D. H. T.

No difficulties are likely to arise in making these modifications, but an accumulator of adequate capacity must be used; to prevent appreciable voltage drop in the leads, extra heavy cable should be used for wiring the heater circuits.

You will probably wish to use a two-cell L.T. battery; if so, it will be convenient to substitute P.X.4 valves for those specified for the output positions.

RULES.

(1.) A query must be accompanied by a COUPON removed from the advertisement pages of the CURRENT ISSUE.

(2.) Only one question (which must deal with a single specific point) can be answered. Letters must be concisely worded and headed "Information Department."

(3.) Queries must be written on one side of the paper and diagrams drawn on a separate sheet. A self-addressed stamped envelope must be enclosed for postal reply.

(4.) Designs or circuit diagrams for complete receivers or eliminators cannot ordinarily be given; under present-day conditions justice cannot be done to questions of this kind in the course of a letter.

(5.) Practical wiring plans cannot be supplied or considered.

(6.) Designs for components such as L.F. chokes, power transformers, complex coil assemblies, etc., cannot be supplied.

(7.) Queries arising from the construction or operation of receivers must be confined to constructional sets described in "The Wireless World" to standard manufactured receivers; or to "K.U." sets that have been reviewed.

A BETTER UNIT



F. A. HUGHES & CO., LIMITED, 204-6 Great Portland Street, W.1
 Distributors for Northern England, Scotland and North Wales: H. C. RAWSON (Sheffield and London), LTD., 100, London Road, Sheffield. 22, St. Mary's Parsonage, Manchester.

27/6

**THE ALL-ELECTRIC
R.G.D. RADIOGRAMPHONE**

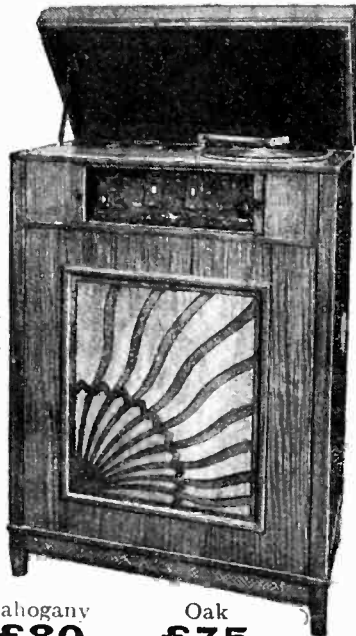

for A.C. or
D.C. MAINS
with COIL-
DRIVEN
SPEAKER
as described in
"Wireless World,"
March 26th.

*A highly
finished
Instrument
of quality.*

*We shall be pleased
to supply literature
on application. Trade
agencies vacant.*

Mahogany £80 Oak £75

The Radiogramphone Development Co.,
72, MOOR STREET, BIRMINGHAM.

A P.C.

posted to-day will
bring you by re-
turn particulars
of how you can
operate an

A.C.

All-Electric Re-
ceiver from a

D.C.

supply main,
by using the



D. C. to A. C.
**ROTARY
TRANSFORMER**

Write for Pamphlet 596/1.

M-L MAGNETO
SYND. LTD.
Radio Dept.
COVENTRY.
Telephone: 5001.

Can be supplied to run from any voltage
12-250 V.D.C. 40 watt model £13; 85
watt model £19.
Recommended and used by Philips Radio,
Marconi phone, Burndept, Kolster-
Brandes, M.P.A., etc., etc.

**German Radio Exhibition
Berlin 1930** in connection with the

22-31/8

**Talking
Machine
and Record
Exhibition**



Any further information will be readily given by the Aus-
stellungs-, Messe- u. Fremdenverkehrs-Amt der Stadt Berlin.
22. Königin-Elisabeth-Straße, Charlottenburg 9

The
Yachting World
and Motor Boating Journal

The Leading British Yachting Journal

"THE YACHTING WORLD" deals with
yachts and boats of all types and tonnages,
whether on the sea or inland waters. Every
aspect of yachting and motor boating is covered
in an attractive and interesting manner.

Every Friday 6D.

ILIFFE & SONSLtd., Dorset House, Tudor St., London, E.C.4

MISCELLANEOUS ADVERTISEMENTS.

NOTICES.

THE CHARGE FOR ADVERTISEMENTS in these columns is:

12 words or less, 2/- and 2d. for every additional word.

Each paragraph is charged separately and name and address must be counted.

SERIES DISCOUNTS are allowed to Trade Advertisers as follows on orders for consecutive insertions, provided a contract is placed in advance, and in the absence of fresh instructions the entire "copy" is repeated from the previous issue: 13 consecutive insertions 5%; 26 consecutive, 10%; 52 consecutive, 15%.

ADVERTISEMENTS for these columns are accepted up to **FIRST POST ON THURSDAY MORNING** (previous to date of issue) at the Head Offices of "The Wireless World," Dorset House, Tudor Street, London, E.C.4, or on **WEDNESDAY MORNING** at the Branch Offices, 19, Hertford Street, Coventry; Guildhall Buildings, Navigation Street, Birmingham; 260, Deansgate, Manchester; 101, St. Vincent Street, Glasgow, C.2.

Advertisements that arrive too late for a particular issue will automatically be inserted in the following issue unless accompanied by instructions to the contrary. All advertisements in this section must be strictly prepaid.

The proprietors retain the right to refuse or withdraw advertisements at their discretion.

Postal Orders and Cheques sent in payment for advertisements should be made payable to **ILIFFE & SONS Ltd., and crossed & Co. Notes being untraceable if lost in transit should not be sent as remittances.**

All letters relating to advertisements should quote the number which is printed at the end of each advertisement, and the date of the issue in which it appeared.

The proprietors are not responsible for clerical or printers' errors, although every care is taken to avoid mistakes.

NUMBERED ADDRESSES.

For the convenience of private advertisers, letters may be addressed to numbers at "The Wireless World" Office. When this is desired, the sum of 6d. to defray the cost of registration and to cover postage on replies must be added to the advertisement charge, which must include the words Box 000, c/o "The Wireless World." Only the number will appear in the advertisement. All replies should be addressed No. 000, c/o "The Wireless World," Dorset House, Tudor Street, London, E.C.4. Readers who reply to Box No. advertisements are warned against sending remittance through the post except in registered envelopes; in all such cases the use of the Deposit System is recommended, and the envelope should be clearly marked "Deposit Department."

DEPOSIT SYSTEM.

Readers who hesitate to send money to unknown persons may deal in perfect safety by availing themselves of our Deposit System. If the money be deposited with "The Wireless World," both parties are advised of its receipt.

The time allowed for decision is three days, counting from receipt of goods, after which period, if buyer decides not to retain goods, they must be returned to sender. If a sale is effected, buyer instructs us to remit amount to seller, but if not, seller instructs us to return amount to depositor. Carriage is paid by the buyer, but in the event of no sale, and subject to there being no different arrangement between buyer and seller, each pays carriage one way. The seller takes the risk of loss or damage in transit, for which we take no responsibility. For all transactions up to £10, a deposit fee of 1/- is charged; on transactions over £10 and under £50, the fee is 2/6; over £50, 5/-. All deposit matters are dealt with at Dorset House, Tudor Street, London, E.C.4, and cheques and money orders should be made payable to Iliffe & Sons Limited.

SPECIAL NOTE.—Readers who reply to advertisements and receive no answer to their enquiries are requested to regard the silence as an indication that the goods advertised have already been disposed of. Advertisers often receive so many enquiries that it is quite impossible to reply to each one by post.

"WIRELESS WORLD"

INFORMATION COUPON

This Coupon must accompany any Question sent in before

JULY 30th, 1930

For Particulars of Free Service, see Rules on page 94.

WITHOUT FEAR—
Send your material for credit—where radio part exchange began. A service relied only by economics, above bargaining or petty gain.
Particulars from the Secretary,
HONOR OMNIA APPLEBY'S,
Chapel St., Marylebone, London
SUPER

SEND TO-DAY FOR OUR FREE 36-PAGE BOOKLET "SOUND ADVICE."

The Finest High-grade Speaker in the World

PERFECT RECEPTION FOR MUSIC LOVERS

BAKER'S 'Selhurst' RADIO

Super Power Moving Coil Speaker.

Offices: 89, Selhurst Rd., S. Norwood, S.E.25.
Works: 42, Cherry Orchard Rd., E. Croydon.

IMPORTANT NOTICE.
Owing to the August Bank Holiday, the issue of "THE WIRELESS WORLD" for August 6th must be closed for press earlier than usual.
MISCELLANEOUS ADVERTISEMENTS for insertion in that issue can be accepted up to
FIRST POST WEDNESDAY, July 30th.

POWER CHOKES guaranteed twelve months substantially built, for smoothing circuits in eliminators dealing with currents 100 to 300 milliamperes, inductance 30 henries, 8/6 post free

REPAIRS to any make of L.F. Transformer, Loudspeaker or Headphones. All repairs dispatched within 48 HOURS. **TWELVE MONTHS' GUARANTEE** with each repair. 4/- Post Free. *Terms to Trade.*

TRANSFORMER REPAIR CO.
Dept. W.,
953, GARRATT LANE, TOOTING, LONDON, S.W.17.

R & B MAINS TRANSFORMER MODEL 34
Designed for the "BAND PASS FOUR" as specified in the June 25th issue.
PRICE £2.5.0

Please state Mains Voltage & Frequency.
Manufactured by **RICH & BUNDY, LTD.**
13, New Road, Ponders End, Middlesex.
Phone: Enfield 0777.

City Retail Stockist:
E. G. WOOD, 2, Queen Street, E.C.4. *Phone: City 5165.*

ELEX

WANDER PLUGS
Actual size, nickel plated, 6 colours. 2DW Standard size, 2DW or Midgot, 24. each.
Write for List X103.

J. J. EASTICK & SONS,
118 Bunhill Row, London, E.C.1

RECEIVERS FOR SALE.

SCOTT SESSIONS and Co., Great Britain's Radio Doctors.—Read advertisement under Miscellaneous. [0264]

HIRE a McMichael Portable Set, by day or week, from Alexander Black, Wireless Doctor and Consultant, 55, Ebury St., S.W.1. Sloane 1655. [0328]

OSRAM Music Magnet, assembled, £6; Lissen 2-valve portable, A.C. mains, £7/10; both complete with valves, perfect.—52, Greenfield St., Commercial Rd., E.1. *Phone:* Bishopsgate 4593. [1018]

ALL Mains 3-valve Set, new, good components, £10; **A Wireless World** back numbers, June, 1929, to July, 1930, 7/6.—Collett, 39, Shirley Rd., Addiscombe. [1014]

LARGE Celestion Speaker, 24in., in oak, cost about £21, £8/10 for quick sale, can be heard by appointment; also Marconiphone 6-valve receiver, model 61, 6v., £18.—Hoather, Bushey Heath, Herts. [1013]

ELSTREE Six for Sale, all components as specification, coils both wave lengths, 2v. valves; best offer.—Box 6821, c/o *The Wireless World.* [1006]

MCMICHAEL Super Range Portable, new, used few demonstrations only; sacrifice, £15/15.—Bell's, 45, Newington Butts, S.E.11. [1003]

BERCLIF D.C.2 All Mains Receiver, 200 to 250 volts D.C.; price £14/10; with valves and royalties, suitable for M.C. speaker; particulars free; trade inquiries specially invited.—Simmonds Bros., Shireland Rd., Smethwick. [8734]

YOUR Old Receiver or Components Taken in Part Exchange for New; write to us before purchasing elsewhere, and obtain expert advice from wireless engineer of 25 years' professional wireless experience; send a list of components or the components themselves, and we will quote you by return post; thousands of satisfied clients.—Scientific Development Co., 57, Guildhall St., Preston. [0225]

SUPERHET 7-valve, finest quality throughout, superb tone, over 40 stations on frame aerial, complete, minus speaker; £10.—Glanville, 129, Love Lane, Mitcham. [1045]

3V. Set, S. G. and Pentode, dual range, Exide H.T. L.T., trickle charger (220v.) speaker, £8; another 3v. speaker, £4.—Bryant, 2, South Ridgway Place, Wimbledon. [1044]

SCREENED Grid Pentode Receiver, battery or mains, cheap; new; also components and valves; send list.—L. M. H., 6, Alcester Rd., West Derby, Liverpool. [1039]

5-VALVE Suitcase Portable, excellent tone, good range, new, £6/17/6; also cabinet loud-speaker, 17/6.—Gray, 55, Larkwood Rd., South Chingford. [1038]

ACCUMULATOR HIRE.

DON'T Buy Accumulators or Dry Batteries, join our C.A.V. low- and high-tension accumulator hire service, the largest and best in London; better and cheaper reception with no trouble; regular deliveries within 12 miles of Charing Cross; no deposit, payment on each delivery or by quarterly subscription; over 10,000 satisfied users; explanatory folder post free; phone or write to-day.—Radio Service (London), Ltd., 105, Torrington Av., N.W.5. *Phone:* North 0623-4-5. [8751]

CHARGERS AND ELIMINATORS.

CHESTER BROS.—All types of mains transformers and chokes to any specification.—Chester Bros., 244, Dalston Lane, London, E.8. [9798]

TANTALUM and Liorium for A.C. Rectifiers; for inexpensive chargers; blue prints for H.T. and L.T., 1/- each; Liorium electrodes, 2-3 and 5-8 amps.—Blackwells Metallurgical Works, Ltd., Garston, Liverpool. [8298]

RADIELLE D.C.100 (200-250 D.C.), output 200 volts 100 m.a., and 2 variable tapplings; cost £9/10, sell £2/5; brand new; send o.d.—Priestley, 8, Grosvenor Gardens, Muswell Hill, London, N.10. [1012]

IGRANIC Combined H.T. Supply Unit and Accumulator Charger from A.C. Mains, universal 110-220, 200v. 30 m.a. output; charges 4v. accumulator; complete with both rectifying valves; cost £16, price £8; 2PM 24A valves.—Percy, 20, Bond St., Basing. [1033]

Chargers and Eliminators.—Contd.

PHILIPSON'S Safety High Tension Supply Units for A.C. and D.C. Mains, 200-250 volts 40-60 cycles, also 230 volts 25 cycles.

10/- Down and Small Monthly Payments Secures the Finest I.T. Supply Available.

PHILIPSON'S Safety H.T. Units are Guaranteed for 12 Months Against All Defects.

ALL Models Sold on 7 Days' Approval to Ensure Complete Satisfaction.

PHILIPSON'S Safety I.T. Units are the Cheapest to Install and the Cheapest to Run; £1/17/6 to 46.

WRITE for Our Booklet, "Radio Power," which gives illustrations and full particulars.

PHILIPSON'S Safety Loud Speaker Output Filters for All Receivers, power valve, or Pentode; a remarkable output filter at a very low price; 10/6.

PHILIPSON and Co., Ltd., Radio Engineers, Astley Bridge, Bolton. 'Phone: 2038 Bolton. [0318]

TRANSFORMERS: Ready Power London.—Transformers and chokes for eliminators and chargers; the best and cheapest British made; list free.—Lallemand, 5, Charles St., Hatton Garden, London, E.C.1. [1030]

ELIMINATOR for Sale, for D.C. mains, voltage 220;—Write, or call after 6 p.m., Mr. P. Seales, 29, Pandora Rd., West Hampstead. [1007]

HENDERSON D.C. H.T. Eliminator, 240 volts mains, one variable, one power output, as new; 30/-.—Redcot, Arthurs Hill, Shanklin, I.O.W. [1031]

SAVAGE'S Specialise in Wireless Power from the Mains; reliable apparatus at reasonable prices.

SAVAGE'S—Transformer laminations and Bakelite bobbins; intending home constructors should write for list.

SAVAGE'S—Reliable smoothing condensers, 1,500 volt D.C. test, 1 mfd., 2/-; 2 mfd., 3/-; 4 mfd., 5/3; 500 volt D.C. test, 1 mfd., 1/6; 2 mfd., 2/3; 4 mfd., 3/9.

SAVAGE'S—Super smoothing and output chokes, many types available; write for list.

SAVAGE'S—Mains transformer for Westinghouse H.T.4 unit, with additional winding, 4 volts centre tapped 3 amps, 23/-; transformers for other Westinghouse units available.

SAVAGE'S—Mains equipment for new Foreign Listeners Four, transformer N.P.L.4, 33/-; smoothing choke, C32G, 20/-; output choke C32O, 20/-.

SAVAGE'S—Mains equipment for Power Pentode Two transformer, P.P.2, 33/-; output choke, L.C. 36P.G., 19/6; smoothing choke, L.C.36G, 18/-.

SAVAGE'S—Mains transformer B.T.4, 500-0-500 volts, 120 m amps, 7½ volts 3 amps, 6 volts 3 amps, 4 volts 2 amps, 4 volts 1 amp, 4 volts 1 amp, all centre tapped, specially developed for automatic bias; 57/6.

SAVAGE'S—Mains transformers and power chokes are carefully and individually constructed from first class materials, with an exceptionally generous margin of safety.

SAVAGE'S, 146, Bishopsgate, London, E.C.2. 'Phone: Bishopsgate 6998. [9165]

CABINETS.

CABINETS for All Requirements.—F. W. Ramsey, 63, Shaftesbury St., London, N.1. Clerkenwell 7139. [9736]

DIGBY'S Cabinets.—Table models in solid oak and mahogany; from 11/6 to 71/-.

DIGBY'S Cabinets, fitted with Radion or Resistor ebonite if required.

DIGBY'S Cabinets.—Pedestal model, with separate battery components; from 56/- to £12.

DIGBY'S Cabinets Made to Customers' Own Designs.

DIGBY'S Cabinets.—Write for new 16-page art catalogue.—F. Digby, 9, The Oval, Hackney Rd., E.2. 'Phone: Bishopsgate 6458. [0128]

COILS, TRANSFORMERS, ETC.

TRANSFORMERS and Chokes for Battery Eliminators.—Chester Bros., 244, Dalston Lane, London, E.8 [9706]

E. C. WIRELESS—10 coils for Band Pass Four, 45/-, complete as specified; please ask us to quote for other coils, special jobs, etc.—28, Premier Place, High St., Putney, S.W.15. [1032]

TRANSFORMERS, chokes, every description made. Enquiries, Stoleys, 125, Eswyn Rd., Tooting, S.W.17. [1028]

IDEAL Home Coils, complete, 30/-; W.W. mains transformer, 25/-; engineer made.—Dewhurst, 2, Bracewell Rd., London, W.10. [1027]

SCREENS (Aluminium), cylindrical, for Foreign Listener's Four coils, correct dimensions; set of 3, 5/6; sent c.o.d.—Lallemand, 5, Charles St., Hatton Garden, London, E.C.1. [1029]

BAND-PASS Four, Coils, complete, 80/-; Ideal Home receiver coils, complete, 43/-; superhet. adaptor coils and base, 24/-; S.G. S.W. Three, 4 coils, 34/-; 4 additional, 46/-; Bercliff coils from stock for all popular sets; trade supplied.—Simmonds Bros., Shireland Rd., Smethwick. [9941]

FERRANTI R.F. 1 and 2 Astatic Aerial Coils, interval transformers, reaction winding, as used in Ferranti screen grid 3, 6/- each; 2 sets Lotus dual range coils, as used in Lotus 3-valve set, 10/- each.

SPECIAL Power Transformers, 25-60 cycle, 200-250 volt, 200 volts 120 m.a. half-wave secondary, 2 4-volt 4 amp. C.T., one 14 volt 1.5 amp.; 30/- each.—S. J. Smith, 102, West Regent St., Glasgow, G.3. [1036]

LOUD-SPEAKERS.

EPOCH Moving Coil Speakers are Masterpieces, designed and produced by master engineers.

EPOCH Moving Coil Speakers are the Standard by which other Speakers are Compared.

EPOCH Moving Coil Speakers are in Use in Many Editorial Offices.

EPOCH Moving Coil Speakers are in Use in Several Famous Laboratories.

EPOCH Moving Coil Speakers are in Use in Many Broadcastng Stations.

EPOCH Moving Coil Speakers are in Use by Most Prominent Musicians.

EPOCH Moving Coil Speakers Bring Unbounded Joy to Thousands upon Thousands of Homes.

EPOCH Moving Coil Speakers, the only speakers that give clear, uncoloured reproduction.

EPOCH Moving Coil Speakers do Render Speech Perfectly and Music Correctly.

EPOCH Moving Coil Speakers Provide the Perfect Illusion of the Artist's Presence.

EPOCH Moving Coil Speakers Represent the Finest Intrinsic Value Ever Offered.

EPOCH Moving Coil Speakers are Guaranteed for a Year, but last for ever.

EPOCH Moving Coil Speakers Bring the Grand Concert out of the Most Modest Set.

EPOCH—You can hear a hundred moving coil speakers, but Epoch is different.

EPOCH—If you own the best set, only by Epoch can you confirm it.

EPOCH—Away with the tin can and cracked banjo reproduction, and install an Epoch.

EPOCH—Away with the drumminess, droniness, and huskiness of the average moving coil speakers.

EPOCH—The clearest, sharpest, cleanest, reproduction—a marvel of accuracy and beauty.

EPOCH Moving Coil Speaker Models from £2/10 to £30.

EPOCH Moving Coil Speakers.—Models for every requirement and taste.

EPOCH Permanent Magnet Moving Coil Speakers.—Nine models from £3/15.

EPOCH Permanent Magnet Moving Coil Speakers Require no Mains or Batteries.

EPOCH Permanent Magnet Speakers are more Sensitive than most Energised Moving Coil Speakers.

EPOCH Energised Models are the Finest ever put on the Market.

EPOCH Super Cinema Speaker has Created the Biggest Sensation for Many Years.

EPOCH Super Cinema Model is many times as Sensitive as the so-called Supers.

EPOCH Super Cinema Speakers give Enormous Volume from a 1-watt Amplifier.

EPOCH Super Cinema Speakers are used on many 100-watt Amplifiers and never "rattle."

EPOCH Super Cinema Model is Standard on several Talkie Equipments.

EPOCH Super Cinema Model is already in use in over 200 Cinemas.

EPOCH Super Cinema are the only Moving Coil Speakers used in Large Theatres, unaided.

EPOCH Super Cinema Speakers provide alone the Upper as well as the Lower Register.

EPOCH—Other Moving Coil Speakers require the help of exponential horns to provide depth.

EPOCH—A list of many prominent cinemas using the Speakers supplied on request.

EPOCH Speakers are not Made of Tin or Aluminium Stampings, but are sound, solid, engineering jobs.

EPOCH Heartily Invite Comparison, on all counts, with any make, regardless of price or claims.

EPOCH—Don't accept our quality claims without verification, but don't accept any other maker's either.

EPOCH—Order one on 7 days' approval, and test with a switch-over; the only real test.

EPOCH Moving Coil Speakers may be heard in our Demonstration Room Daily.

EPOCH—Our demonstration room is in the heart of London.

EPOCH—Its accessibility has been studied for the convenience of callers.

EPOCH—If you cannot call, write for booklet W.S.3, and approval terms.

EPOCH RADIO MANUFACTURING Co., Ltd., Parrington Av. (near Ludgate and Holborn Circus), 'Phone: Central 1971. 18983

Loud-Speakers.—Contd.

BAKER'S SELHURST RADIO 36-page Booklet. "Sound Advice is Yours for the Asking"; write now for new edition; see displayed advertisement on page 7. [0231]

MAGNAVOX Moving Coil Unit, 6-volt D.C. model, £3/10; Magnavox moving coil unit, 200-220 volt, A.C. model, £5/10.—Dipple, 186, Barking Rd., London, E.16. [1022]

CELESTION, guaranteed perfect, cost £6/10, sacrifice 55/-—60, Adelaide Rd., Southall. [1021]

MARCONI Moving Coil Speaker, 200-250 D.C., and V.P.K. camera, £3, or offer.—Smith, 116, Park St., Southend. [1008]

ROLA Moving Coil Loud-speakers, 6-volt field, input transformer, scratch filter, unused, 8in. ribbed cones, 6 at £4/10 each; also Magnavox X-core, with 10in. cone.—S. J. Smith, 102, West Regent St., Glasgow, G.3. [1035]

GAMBRELL Novotone, new; £3, cost £5.—Howell, 211, Queen's Rd., Wimbledon, S.W.19. [1043]

MAGNAVOX Coil Drive Speaker, 200 volt field, £3; also R.C.A. speaker, 200-350 volt field, £4; and Fada for A.C., £6; both as brand new and unused.—16, Denbigh St., S.W.1. Vic. 7705. [1037]

AMPLION Lion Power Chassis, 18in., perfect condition; 82/6, or offer.—Gordan, 29, Maitland Park Villas, Hampstead, N.W.3. [1024]

DYNAMOS, ETC.

DYNAMOS and Motors, Rotary converters and motor generators, 2,000 in stock at bargain prices.—Electradix Radios, 218, Upper Thames St. [9987]

SIX M.L. Motor Generators, input 230v. D.C., output 450v. D.C., 300 m.a.; 3 ditto, input 210v. A.C., similar output, £5/10, carriage extra; smoothing equipment for H.T. and L.T., £2 extra.—Franks, 42a, St. George's St., London, E.1. 'Phone: Royal 8546. To callers in 5.30-7.30 p.m. [1046]

GRAMOPHONES, PICK-UPS, ETC.

HAVE Gramophone Motor, any voltage; what have you?—Fuller, 87, Euston St., London. [1001]

PICTURE RECEIVER APPARATUS.

TELEVISION—Scanning discs, Neon tubes, experimental models made.—John Salter, Member Television Society, Featherstone Buildings, Holborn, W.C. [9892]

TRANSMITTERS.

84-METRE Crystals for Transmitter Control; 17/-.—Smith, Bryn Rodyn, Colwyn Bay. [1020]

VALVES.

AMPLIFIER Valve.—If you require power you cannot do better than one of these (or matched in pairs if required).

FILAMENT Volts 6, plate volts 400 (maximum) grid bias 84 volts (approx.), impedance 800 ohms, amplification factor 3.8, mutual conductance 4.35 m.a./volts; price, £5/10; see article "The Wireless World," 24th July, 1929, then send to North London Valve Co., Ltd., 22½, Cazenove Rd., Stoke Newington, London, N.16. [9964]

150 Various 6-volt Type Valves, comprising D.O.60, P.M.256, L.S.5A; American power valves and mains valves; Metrovick mains and rectifying valves, viz., A.C.R., A.C.G., A.C.X., S.P.41U., B.H. R.H.I., Marconi K.L.1, at bargain prices.—To callers only, 5.30-7.30 p.m., evenings.—Franks, 42a, St. George's St., London, E.1. 'Phone: Royal 8546. [1048]

VALVES, P.240, 9/-; D.E.L.210, H.L.210, P.M.256, P.M.6, 7/6 each; S.215 and P.M.22, 15/- each; 2v. 40 amp. Exide ace, 10/-; E.M. speaker unit, £1; joint switch, 3/-; Ormond 0.0005 2-gang, 10/-; 2 0.0003 Weartite S.M. Midget condensers, 6/- each; all perfect.—Eason, 55, Whitting Av., Merton Park, S.W.20. [1026]

VALVES, as new, guaranteed, 4 P.M.6, 4/6 each; 8 P.M.5X, 5/- each; 3 P.M.36, 10/- each; 2 D.E.H.610, 4/6 each; 2 D.E.P.610, 4/6 each; 3 P.M.14, 8/6 each; P.M.256, 7/6; D.E.L.612, 4/6; P.M.16, 8/6; L.S.5B, 10/6; P.M.4D, 4/6; P.M.254, 7/6; P.M.24, 10/6; P.M.3A, 4/6; P.M.4, 4/6; D.E.H.612, 4/6.—Hills, 13, Golden Sq., W.1. [1056]

P.M.1 H.F., 5/6; P.M.2, 6/6; P.M.22, 10/6; A.C./R. 7/6.—Box 6889, e/o The Wireless World. [1054]

COMPONENTS, ETC., FOR SALE.

BELLING-LEE Panel Fittings are designed to give an expert finish to any home-constructed set; catalogue post free.—Belling and Lee, Ltd., Queensway Works Ponders End, Middlesex. [0018]

COMPONENTS Lent on Hire.—Details from Alexander Black, Wireless Doctor, 55, Ebury St., S.W.1. Sloane 1655. [0329]

19 30 Keystone Ether Searcher; 15/6; wireless sets and spares supplied for cash or terms; Provident and other trade checks accepted.—Acacia Stores, 229-331, Upper Tooting, S.W.17. [9925]

LOTUS Remote Control, 2 jacks, 12/6; Standard 4 type coils, both bands, bases, 20/-; valves, P.M.16, 11/-; H.L.610, 5/6; P.625A, 7/6; accumulators (collected only) Exide 2, 4 and 6 volts, 30 and 60 amps, Exide and Fuller 120 volts 2,500 m.a., all perfect condition; half list prices.—51, Beechwood Av., Kew. [1017]

Mention of "The Wireless World," when writing to advertisers, will ensure prompt attention.

Components, Etc., for Sale.—Contd.

TWO Cosor S.G. Valves, 2 volt (S.G.210), horizontal type, as new, 6/- each; complete set 6 Lewcos 6-pin coils (4 split primary transformers, 2 S.P. aeriols for both wavelengths), 3 circular bases; £1.—Edward, 68, High St., King's Heath, Birmingham. [1009

UNUSED Marconiphone D.C.3 H.T. Eliminator, 20/-; Telsen Ace 5.1, 6/-; oak cabinet, 27in. x 9in., 15/-; B.T.H. pick-up, 20/-; all guaranteed.—Pawley, 54, Pencilsly Rd., Cardiff. [1005

FERRANTI 250 volt Trickle Charger, new, 35/-; 8825 valve, 7/-.—Kirkpatrick, 56, Grätwicke Rd., Worthing. [1004

BARGAINS in Components.—See new sale list; switchgear and resistances built to order; slider wire wound, 2,300 ohms, iron clad; 17/6.—Electradix Radios, 218, Upper Thames St. [9988

AIRFORCE 2-valve Transmitters, Mark II, contains transformer, choke, high voltage condensers, ammeter, multi-cables, and many other useful parts; made by G.E.C.; new and unused; complete in carrying case, 10/-, carriage extra.—Modern Radio, 37, Lisle St., W.C.2. [1034

CELESTION C14, oak, £6; dual gramophone motor, electric universal, £4; pair Cyldon 0.0005, drum dials, £1; all perfect; deposit.—Box 6885, c/o The Wireless World. [1050

FERRANTI AF5, unused, 19/6; oak Camco cabinet, 21in. x 7in. x 12in., unscratched, 21/-; Igranio 30, 25, 75, 50, 5/-; Dimic, No. 1 and No. 0, 2/6 each; Bluespot unit, 12/6.—Wakefield House, Camberley. [1040

BARGAINS, cheap.—Ferranti O.P.M.1, 12/-; O.P.M.2, 12/-; B2 choke, 100 m.a., 11/-; Pye 20 Henri choke, 6/-; B.T.H. 30/1 microphone transformer, 7/6; Lotus D.P.D.T. switch, 2/-; B.T.H. 1930 pick-up and tone arm, 22/6. Valves, used few hours only; original boxes: 2 B.T.H. P x 650, 8/9 each; Mazda P.650, 10/-; Mazda A.C.P., 9/-; Met-Vick A.C.P.1, 9/-; Met-Vick S.P.42U, 250/60 rectifier, 9/-; Osram P.625A, 8/-; 2 Osram L.S.5A, 8/3 each. Amplion Lion speaker, L.C.14, chassis type, £2/15; all above guaranteed perfect, as new; can be seen after 6.30 p.m.—Holland, 27, Nursery Row, Walworth, S.E.17. [1025

RADIO HOUSE, HUDDERSFIELD, issues the Reliability Wireless Guide, which will be sent post free upon request by Messrs. J. H. Taylor and Co., 15, Macaulay St., Huddersfield. [7823

PART Exchange.—See our advertisement under Receivers for Sale.—Scientific Development Co., 57, Guildhall St., Preston. [0228

FIVE 3-valve Push-pull Amplifiers, each containing one Ferranti A.F.3C, ditto, O.P.4C Hydra condensers, decoupling resistances, valve holders, terminals, etc., wired O.K., components as new, suitable for radio-gram work; 32/6, carriage paid.—Franks, 42a, St. George's St., London, E.1. Phone: Royal 8546. To callers in 5.30-7.30 p.m. [1047

ECKO D.C. All-power Eliminator, type C.I.A. (cost £9/15), £4/10; ditto, type O2A, £2/15; ditto, H.T. A.C., type I.V.20, £2/10; ditto H.T. D.C., 10/-; Pormo impedance coupler, 7/6; A.C. filament transformer, 10/-; M-L Anode converter, 12v, 300 v. 50 m.a., £8/8 (as new); Ferranti H.T. eliminator, B.E.M.1, £8/8 (as new); Ferranti transformers, 2 A.F.5, 15/- each; A.F.3, 12/-; O.P.21, 10/-; O.P.40, 12/-; O.P.90, 12/-; 25-1 output, 10/-; 2 R.I. Varley filter chokes, 5/- each; 3 R.I. Varley R.C. couplers, 5/- each; Cosmos E.C. coupler, 2/6; 1 Harlio M.C. speaker (H.R.), 15/-; Ferranti 0.15 millimeter (as new), £1; 5 G.H. 373 double impedance couplers, 10/- each; Polar H.F. unit, 10/-; B.B.O. wave trap, polished case, 10/-; ditto, 5/-; G.R. speaker filter, 7/6; Igranio pentode, 12/6; 4ft. M.P.A. folding frame aerial, 10/-; 2 old type Baker M.C. speakers, with extra spiders coils, cones, etc., 30/-.—Hills, 13, Golden Sq., W.1. [1057

SIPAM Moving Coil Meter, 0-50 m.m., 10/6; 0-100 m.m., 10/6; R.I. L.F. choke, 28/14H, 10/6; Nicore II, 7/6; Polar drum twin, 0.0005, 12/6.—Box 6890, c/o The Wireless World. [1055

MISCELLANEOUS.

SCOTT SESSIONS and Co., Great Britain's Radio doctors, officially approved as wireless repairers by Radio Society of Great Britain and Wireless League; old sets of every type repaired, rebuilt, modernised; send set for immediate quotation.

SCOTT SESSIONS and Co.—New sets constructed with your or our components, guaranteed finest workmanship; we specialise in "The Wireless World" circuits; remember, we have satisfied customers throughout the British Isles and in three Continents; if you so desire, we will design and construct high grade apparatus to suit your special circumstances for quality, range and selectivity.—Tel.: Tudor 5326. Muswell Hill, London, N.10. [0262

ALEXANDER BLACK.

THE Original Wireless Doctor, will call (London and Home Counties) and cure your set.

CONSULTATIONS by Appointment Without Obligation, sets installed, maintained, and brought up to date, gramophone pick-ups, eliminators, and Webber moving coil speakers demonstrated; purity reproduction specialists.

55, Ebury St., Victoria, S.W.1. Sloane 1655. [0277

TYPEWRITER, L. O. Smith, reliable machine; £5/10, or exchange good wireless set.—Box 6873, c/o The Wireless World. [1011

DEAF AIDS

(INEXPENSIVE)

Efficiency Guaranteed. Better than other Aids costing Five times as much

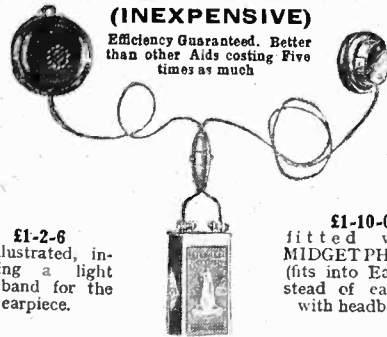

£1-2-6 as illustrated, including a light headband for the earpiece.

£1-10-0 fitted with MIDGET PHONE (fits into Ear) instead of earpiece with headband.

THIS Aid comprises the latest sensitive SUPER-MICROPHONE (to be attached to Coat or Dress, conveniently concealed), a SMALL BATTERY (for the pocket), and a SMALL EARPIECE which can be held to the deaf ear by hand or by a light headband supplied with the Aid. All speech and sound reaching the Super-Microphone is loudly heard in the earpiece. The battery can be switched off when the Aid is not in use. ANY small 3-volt battery can be used with these Aids.

Either of the above Aids can be made SPECIALLY POWERFUL by fitting a DOUBLE Microphone in place of the single, at an extra cost of 10/-.

FREDK. ADOLPH, Actual Maker, 27, Fitzroy St., London, W.1. Phone: Museum 8329

Why not dance to Radio Paris, Toulouse and Hilversum Music?

With the "Supremus" All Electric 2-Valve Receiver it is the simplest matter. So simple that even a child can operate it. You should hear it. Long and short wave stations can be obtained by the mere operation of a switch. This set is equal to any 3-valve battery operated receiver. London listeners have been specially catered for and stations can be parted easily. There is a 12 months' guarantee with each set.

PRICE £12 : 0 : 0.

Using a "Supremus" All Electric 2-Valve Receiver a Birmingham amateur picked up 18 stations full speaker strength at first attempt.

"SUPREMUS" 2-VALVE ALL ELECTRIC

SUPREMUS SPECIALITIES Ltd., 118, HIGH ST., ERDINGTON, BIRMINGHAM. Northern Agents: THE CHORLTON METAL CO., 18, Amber Street, Manchester. London Agent: P. H. SMEDLEY, 50, Richmond Road, Leytonstone, E.11.

Miscellaneous.—Contd.

EASY Payments.—We supply, by easy payments, components, accessories, and sets, any make; 10% down, balance spread over 11 months.—Send list of requirements to London Radio Supply Co., 11 Oak Lane, London, E.C.2. [0537

COMFORTABLE Digs. for Wireless Students Studying in London, good food; very moderate.—Moore, 41, Finborough Rd., South Kensington, London, S.W.10. Phone: Kensington 1427. [9857

ENGINEERS, novice or expert, £300, £400, £500 per year or more is within your grasp; in our handbook "Engineering Opportunities," Prof. A. M. Low explains where the good posts abound; this handbook has shown the way to better things to over 20,000 of your fellows; it contains details of A.M.I.Mech.E., A.M.I.E.E., A.M.I.C.E., A.M.I.A.E., A.M.I.Struct.E., Matric, C. and G., G.P.O., etc. exams., outlines home study courses in all branches of electrical, mechanical, motor, and wireless engineering, and shows the unique advantages of our appointments department; why stay in the Hammer and File Brigade? Send for our free handbook at once, stating branch, post or exam. which interests you.—British Institute of Engineering Technology, 87, Shakespeare House, 29-31, Oxford St., London, W.1. [9912

PATENT AGENTS.

PATENTS and Trade Marks, British and foreign.—Gee and Co. (H. T. P. Gee, Member R.S.G.B. and A.M.I.R.E.), 51-52, Chancery Lane, London, W.C.2. Phone: Holborn 1525. [0001

REPAIRS.

SCOTT SESSIONS and Co., Great Britain's radio doctors; read advertisement under Miscellaneous column. [0263

THE BARNES RADIO SERVICE.—Repairs, rebuilding, demonstrations, radio gramophones and scratch filters; reproduction specialists; any distance.—53, High St., Barnes, S.W.13. Prospect 5633. [9705

YOUR Transformer Rewound or Repaired, and returned promptly; 3/6, post free.—James, 190, Bitterno Rd., Southampton. [1002

GUARANTEED Repairs by Experts.—Loud-speakers, headphones, cone units, pick-ups, any type, rewound, remagnetised, and adjusted post free 4/-; transformers, from 4/-.—Howell, 91, Morley Hill, Enfield, Middlesex. [9555

LOUD-SPEAKERS, headphones, cone units, pick-ups, rewound, remagnetised and adjusted; transformers rewound, all 4/-, post free.—Electrical Products, Willow St., Station Rd., Chingford, Essex. [1041

TUITION.

TYPEWRITING, correspondence courses, technical literature, components and complete sets, are all dealt with; write for complete details; complete index system, 1/6.—Box 6888, c/o The Wireless World. [1053

WANTED.

WANTED, pair Telefunken 'phones, new.—Box 6884, c/o The Wireless World. [1049

0-50 Moving Coil, milliamp., O.P.M.3, Ferranti, Pye chokes; sell P625 Ferranti, 2,000, half price.—20, Brooklands Rd., Birmingham. [1023

BUSINESSES & PROPERTY FOR SALE, TO BE LET, OR WANTED.

ESTABLISHED Wireless School, as sound going concern, excellent reasons for disposal with proof, good income, large operative area; £475, or nearest offer; partnership suggestions possibly considered.—Box 6796, c/o The Wireless World. [9994

WIRELESS and Electrical Business, main road, Croydon, well established, low rent, must sell; bargain, £125, including stock.—Box 6887, c/o The Wireless World. [1052

EXCHANGE.

RADIO Part Exchange.—Particulars of the first and largest service in existence will be forwarded upon request to The Secretary, Appleby's, Chapel St., Marylebone, London. [0339

SITUATIONS VACANT.

WIRELESS Operating; fees payable after appointment; amateur Morse classes.—Manager, Wireless School, 21, Manor Gardens, London, N.7. [9378

WIRELESS Services.—The premier telegraph college in the British Isles (established 34 years) gives a sound training to all students, with assured positions on qualification; fees are not disguised under expensive board-residence scheme, but are payable by easy instalments, if desired.—Apply for Prospectus, Dept. "W.W.," The London Telegraph Training College, Ltd., Morse House, Earl's Court, S.W.5. [9877

£1,000 Per Year.—Men capable of earning this, read on A.O., all mains, 8-valve radio-gram with theatre M.C. speaker, extremely low price, reputable factory wants agents in A.O. districts, whole or part time, car advantage, successful agents later qualify for position district sales manager.—Responsible people only reply with details to "G," Box 5086, Woodwright, 150, New Bond St., W.1. [1010

JERSEY, Channel Islands.—Experienced radio engineer required, fare paid.—Full particulars of experience, references, salary required and photo of self to Bath St. Radio. [1042

A31 Advertisements for "The Wireless World" are only accepted from firms we believe to be thoroughly reliable.

H. & B.

SPECIFIED FOR

D.C. Foreign Listener's "Four."

Tubular Valve Shields	3/6 ea.
Cylindrical Coil Shields	3/- ea.
Copper Screening Boxes for H.F. Chokes with anode tube	3/- ea.
Ditto without tube	2/6 ea.
Aluminum base plate 15 1/2 x 11 in.	2/6 ea.
14" Hard Brass strip for coil-changing switch 1" x 3/32"	6d. ea.

Write for detailed list of components. All cash orders post free.

Trade Supplied.

H. & B. RADIO CO.,
34, 36 & 38, BEAK STREET,
REGENT ST., W.1. Ger. 2834.

BOOKS on WIRELESS

Write for complete list to
ILIFFE & SONS LTD.,
Dorset House, Tudor St., London, E.C.4.

SITUATIONS WANTED.

PUBLIC School Man (26) Desires Situation in Radio-gramophone Trade, technical or administrative; future scope chief consideration, near London, 8 years' commercial experience; secured investment would be considered in established concern.—Box 6876, c/o *The Wireless World*. [1015]

RADIO Engineer Desires Change; 7 years' experience factory and test room, portables, mains receivers, radio-gramophones and public address amplifiers; disengaged 29/7/30.—Box 6877, c/o *The Wireless World*. [1016]

SERVICE Engineer, extensive technical, practical, knowledge everything wireless, requires progressive position, large firm manufacturers.—Harris, 5, Martaban Rd., N.16. [1019]

YOUNG Man, 21, good education, knowledge of French, German, typewriting, first class P.M.G., 1927, 3 years' practical experience, seeks position.—Box 6886, c/o *The Wireless World*. [1051]

BOOKS, INSTRUCTION, ETC.

TELEVISION—The complete authorised book on television (Baird Experimental) transmission and receiving is now ready; order "Television To-day and To-morrow" (Moseley and Barton Chapple), 7/6 net.—Pitman's, Parker St., Kingsway, W.C.2. [9309]

STEP by Step Wireless—A complete course of instruction for wireless engineers; send 1/- for first 4 weeks.—Clifford Pressland, A.M.I.E.E., Hampton-on-Thames. [0195]

FREE: Inventor's Guide on Patents.—T. A. A., 253, (W.) Gray's Inn Rd., London, W.C.1. [6373]

BONA FIDE TRADERS' GUIDE.

Send for our comprehensive Illustrated List.
QUICK SERVICE. QUICK SERVICE.

THE QUALITY HOUSE.

PERSEUS MFG. CO., LTD. (Dept. W.W.)
BRANSTONE RD., BURTON-ON-TRENT.

Specified for the
D.C. Foreign Listener's Four

Polar "Volcon." .0001 mfd.
Polar Catalogue Free.
WINGROVE & ROGERS Ltd.
188-9 Strand, London, W.C.2



POLAR

The Autocar

EVERY
FRIDAY,
FOURPENCE



It would be
FATAL
to lose
CONTROL

Barbed wire—trenches—dug-outs—a field set and a thin strand of wire.

The difference between control and lack of control may spell life or death to an entire brigade.

It's a far cry from No Man's Land to the comforts of your home.

But even in your radio set . . . control plays a vital part . . . and it has been the privilege of **CENTRALAB** to furnish the volume controls of millions of radio receivers.

Is your radio—**CENTRALAB** equipped?



Write for free Booklet,
"Volume Controls,
Voltage Controls,
their uses."

Centralab

THE ROTHERMEL CORPORATION LTD.,
24, Maddox Street, London, W.1.
Phone: MAYFAIR 0578/9.

Continental Sales Office:
27, QUAI DU COMMERCE, BRUSSELS, BELGIUM.

REALISTIC REPRODUCTION

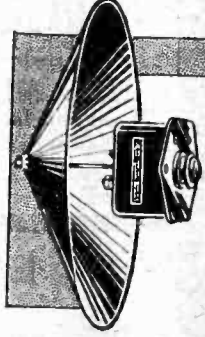

This
SIX-SIXTY CONE-SPEAKER ASSEMBLY

True-to-life realism is a feature of a cone-speaker made with the **SIX-SIXTY CONE-SPEAKER ASSEMBLY**. Many well-known set manufacturers standardise it for its fine performance—you will get the same unspoiled reproduction in your cone-speaker if you use the **SIX-SIXTY CONE-SPEAKER ASSEMBLY**. Make your own cone-speaker—in your own home—but be sure to use the **SIX-SIXTY CONE-SPEAKER ASSEMBLY**. Price 15/-

SIX-SIXTY CONE-SPEAKER ASSEMBLY

Made by the makers of the famous Six-Sixty Valves
Six-Sixty Radio Co. Ltd., Six-Sixty House, 17/18 Rathbone Place, Oxford St., W.1
Telephone: Museum 6116/7

INDEX TO ADVERTISEMENTS.

Adolph, Fredk.	PAGE 9	Holzman, L.	PAGE	Supremus Specialities, Ltd.	PAGE 9
Appleby, E. Hetherington	7	Hughes, P. A. & Co. Ltd.	5	Telegraph Condenser Co. Ltd.	9
Baker's "Selhurst" Radio	7	Imperial Airways, Ltd.	Cover ii.	Telson Electric Co. Ltd.	Cover i.
Bayliss, William, Ltd.	Cover iii.	Lyons, Claude, Ltd.	Cover i.	Thomas Bertram	Cover ii.
Burton, C. F. & H.	Cover i.	Marconiphone Co., Ltd.	4	Transformer Repair Co.	7
Celestion, Ltd.		McMichael, I., Ltd.		Tungram Electric Lamp Works (Great Britain), Ltd.	Cover i.
Day, Will, Ltd.	2	M-L Magneto Synd., Ltd.	6	Ultra Electric, Ltd.	
Dubilier Condenser Co. (1925), Ltd.	2	Mullard Wireless Service Co., Ltd.	Cover iv.	Vandervell, C. A. & Co., Ltd.	3
Eastick, J. J., & Sons	7	Perseus Manf. Co., Ltd.	10	Wastinghouse Brake & Saxby Signal Co., Ltd.	3
Electradix Radios		Pertrix, Ltd.	10	Weston Electrical Instrument Co., Ltd.	2
Exide Batteries		Radiogramophone Development Co.	6	Wilkins & Wright, Ltd.	
German Radio Exhibition	6	Rich & Bundy, Ltd.	7	Wingrove & Rogers, Ltd.	10
H. and B. Radio	10	Rothermel Corporation, Ltd. (Centralab)	10		
Heyherd, F. C., & Co.		Six-Sixty Radio Co., Ltd.	10		

Mention of "The Wireless World," when writing to advertisers, will ensure prompt attention.

BAYLISS

Superior Quality Power Transformers
and Chokes for the Mains from 35/- each
—to Customers' Requirements.

BAYLISS ROTARY CONVERTERS

A.C. from D.C.

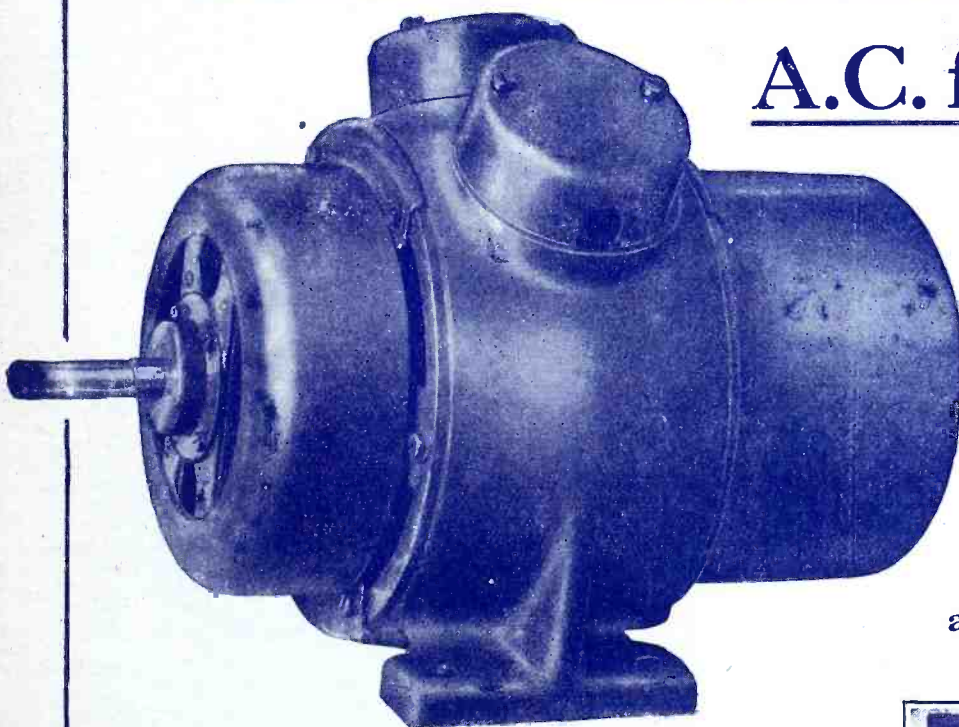

**ANY Input.
ANY Output.**

Loads up to
400 Watts.

PRICE

£12 . 10 . 0

**For Audio
Amplifiers
and General Purposes.**

Also Dynamos,
Motor Generators, etc.
for all purposes.

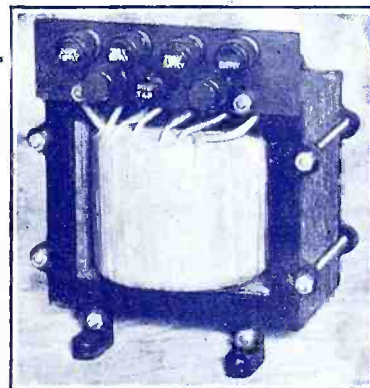

WILLIAM BAYLISS LTD.

Contractors to the Admiralty, War Office, Colonial Governments, etc.

**Sheepcote Street
BIRMINGHAM**

Telephone :
Mid. 1409.

Telegrams :
"Drawbench, B'ham."

Advertisements for "The Wireless World" are only accepted from firms we believe to be thoroughly reliable.

“It sounds good to me...”



Critical you feel; you're waiting to hear the flaw—the flaw that never comes. Listening for the imperfection that isn't there. That's typical of the new 'K' Speaker. Whether it be song, story or sonata, its performance awakes in you a new interest in radio. Have it in your own home—a thoroughbred that will talk, sing, and play to you.

TYPE 'K'
£6.15.0

Mullard
MASTER · RADIO

Advert. The Mullard Wireless Service Co., Ltd., Mullard House, Charing Cross Road, London. W.C.2.

Printed for the Publishers, LILFIE & SONS LTD., Dorset House, Tudor Street, London, E.C.4, by The Cornwall Press Ltd., Paris Garden, Stamford Street, London, S.E.1.

Colonial and Foreign Agents:
 UNITED STATES—The International News Co., 131, Varick Street, New York. FRANCE—W. H. Smith & Son, 248, Rue Rivoli, Paris; Hachette et Cie, Rue Réaumur, Paris.
 BELGIUM—W. H. Smith & Son, 78, Marche aux Herbes, Brussels. INDIA—A. H. Wheeler & Co., Bombay, Allahabad and Calcutta. SOUTH AFRICA—Central News Agency, Ltd.
 AUSTRALIA—Gordon & Gotch, Ltd., Melbourne (Victoria), Sydney (N.S.W.), Brisbane (Queensland), Adelaide (S.A.), Perth (W.A.), and Lancaster (Tasmania).
 CANADA—The American News Co., Ltd., Toronto, Winnipeg, Vancouver, Montreal, Ottawa, St. John, Halifax, Hamilton; Gordon & Gotch, Ltd., Toronto; Imperial News Co., Toronto, Montreal, Winnipeg, Vancouver, Victoria, New Zealand—Gordon & Gotch, Ltd., Wellington, Auckland, Christchurch and Dunedin.

The Wireless World

AND RADIO REVIEW

4^D

The Paper for Every Wireless Amateur

Wednesday, July 30th, 1930.

*Your final choice
in Radio will be*



ALL-ELECTRIC RADIO

Write for Free Booklet on "All-Electric Radio" and details of Easy Payments to E. K. Cole, Ltd., Dept. W., "Ekco" Works, Leigh-on-Sea.

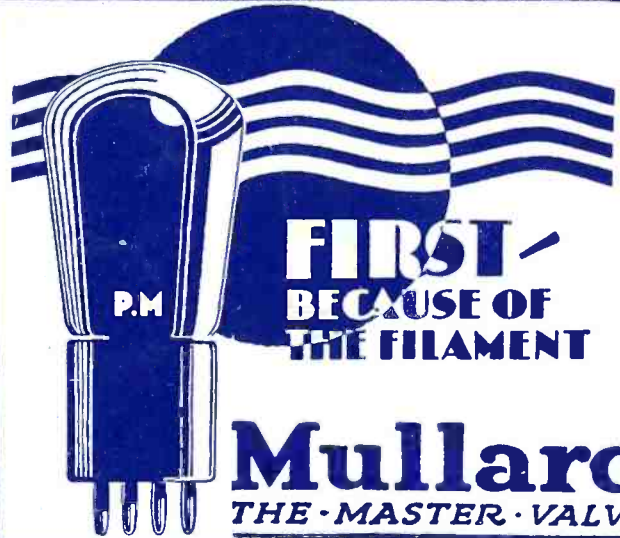

**FIRST-
BECAUSE OF
THE FILAMENT**

Mullard
THE MASTER VALVE

**Condenser ruptured—
Lesson taught—
Hydra next time—
Will be bought!**

LOUIS HOLZMAN LTD. 37, NEWMAN ST., LONDON, W.1. Telephone: Museum 2641.

**A BETTER UNIT
66P**

27/6



Blue Spot

TESTS OF TIME

That fine old London landmark..

... the Law Courts, has been standing since 1882 — for 48 years! It has stood the test of time and is likely to go on standing it for a long, long time. T.C.C. Condensers too, have stood the test of time — and come through with flying colours. If you want your Set to be a success — you cannot disregard the condenser chosen by experts with such astonishing consistency. Ask for T.C.C. — “the condenser in the green case” The condenser with a guarantee!

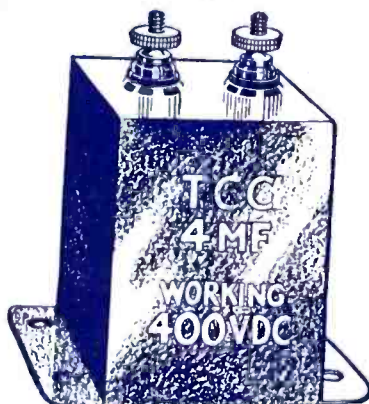

The condenser illustrated is 800 volt D.C. test. 400 D.C. working 8/6

THE LAW COURTS

ADVERT. OF THE TELEGRAPH CONDENSER Co. Ltd. N. ACTON W.3

5366

Mention of "The Wireless World," when writing to advertisers, will ensure prompt attention.

German Radio Exhibition Berlin 1930 in connection with the

22-31/8

Talking Machine and Record Exhibition



Any further information will be readily given by the Ausstellungs-, Messe- u. Fremdenverkehrs-Amt der Stadt Berlin. 22. Königin-Elisabeth-Straße, Charlottenburg 9

EDDYSTONE SHORT WAVE APPARATUS

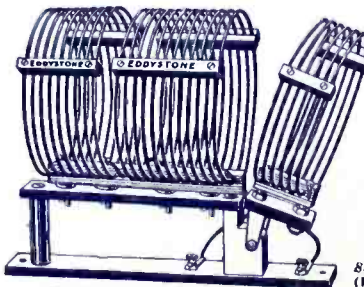

TYPE A.V. INDUCTANCE ASSEMBLY
This complete inductance unit for short wave reception consists of five interchangeable coils with mounting stand, the range from 18-60 metres being covered efficiently with a .00015 condenser. The arrangement makes use of serial, grid and reaction coils; the first named being variable to prevent blind tuning spots. Wound with well-spaced turns, entirely open core and low loss banana-type mounting pins, the short wave performance of the coils is unequalled. Full circuit details enclosed. Extra BBC coils can be supplied.
PRICE 20/- WITH STAND.

Send for complete list (W) of short wave apparatus.

Sole Manufacturers: **STRATTON & CO., LTD., BROMSGROVE STREET, BIRMINGHAM.**

London Service Depot: **WEBB'S RADIO ELECTRIC STORES, 164, Charing Cross Road, W.C.2.**



EVERYTHING **The G.E.C.** ELECTRICAL
your guarantee

Osram Valves

Sold by all
Wireless Dealers

MADE ENTIRELY IN ENGLAND. REDUCED PRICES

The following types of OSRAM VALVES are REDUCED IN PRICE as shown, the reductions becoming operative immediately.

TYPES		OLD PRICES	NEW PRICES	TYPES		OLD PRICES	NEW PRICES
Osram	H.L. 210	10/6	8/6	Osram	P. 2	15/-	13/6
"	H. 210			"	P. 240		
"	L. 210			"	P. 425		
"	H.L. 410			"	P. 625		
"	H. 410			"	P. 625A		
"	L. 410			Osram	S. 215	22/6	20/-
"	H.L. 610			"	S. 410		
"	H. 610			"	S. 610		
"	L. 610	Osram	P.T. 240	25/-	22/6		
Osram	P. 215	"	P.T. 425				
"	P. 410	"	P.X. 4				
"	P. 610	12/6	10/6	"	P.T. 625	30/-	27/6

Prices apply only in Great Britain and Northern Ireland

Advt. of The General Electric Co., Ltd., Magnet House, Kingsway, London, W.C.2.

Advt. for "The Wireless World" are only accepted from firms we believe to be thoroughly reliable.

A Perfect Combination!

The LEWCOS H.F. CHOKE and L.F. TRANSFORMER PROVIDE PERFECT RECEPTION.

LEWCOS L.F. TRANSFORMER.—Treble notes respond admirably, while the bass notes are reproduced with an effect more nearly approaching the true musical tones than is possible with the majority of makes. A feature of the L.F. Transformer is the provision of a Centre-Tapping on the secondary winding which renders it adaptable for push-pull amplification. Scientific research, finest materials and sound workmanship make the L.F. Transformer a worthy addition to the Lewcos range.

LEWCOS H.F. CHOKE.—Tested values of the Lewcos H.F. Choke: Self-capacity—1.62 micro-microfarads (N.P.L. test). Natural Wavelength—5,200 metres (tested with Moullin voltmeter). These figures give assurance that there will be a minimum amount of H.F. Leakage through self-capacity, while the position of the terminals, one at the top of the coil and the other at the base, is arranged so as to eliminate the risk of additional self-capacity in the wiring of the receiver.

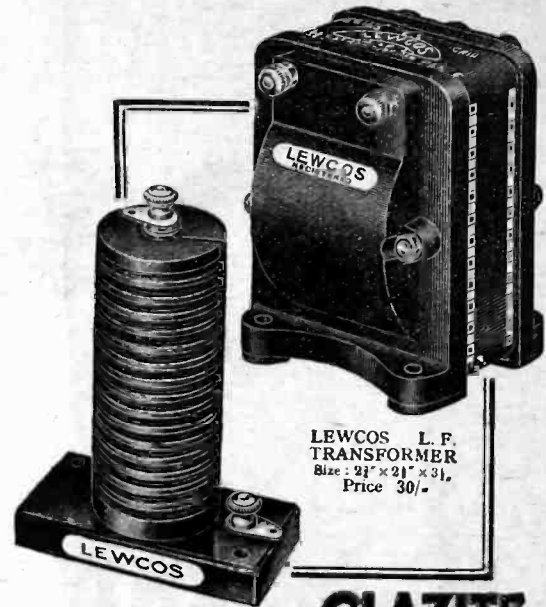

LEWCOS H.F. CHOKE
20-2000 metres.
Price 7/9

LEWCOS L.F. TRANSFORMER
Size 2 1/2" x 2 1/2" x 3 1/2".
Price 3/0.

GLAZITE
BRITISH MADE REGD
Coloured Connecting Wire
in 10 ft. coils.
Price 6d. per coil.



THE LONDON ELECTRIC WIRE COMPANY AND SMITHS LTD.,
Church Road, Leyton, London, E.10.

Stocks held at the following Branches: Belfast, Dublin, Leeds, Cardiff, Glasgow, Liverpool, Manchester, Newcastle, London

WESTINGHOUSE RECTIFIERS

FOR HIGH TENSION BATTERY ELIMINATORS AND CHARGERS

200 volts
100 m.a.
Type H.T.1
75/-



150 volts
50 m.a.
Type H.T.4
37/6



120 volts
20 m.a.
Type H.T.3
21/-



WESTINGHOUSE

METAL RECTIFIERS

are unquestionably the most convenient and reliable means of rectification yet devised. The circuits are simple, and the rectifiers have nothing to wear out and do not require periodical replacement. That is why they are now being used in such large numbers by the leading manufacturers.

"The All-Metal Way, 1930"

32 pages of valuable eliminator information, with circuits, etc. All users of A.C. Supplies should have one.

Send your name and address and a 2d. stamp to:—

The Westinghouse Brake & Saxby Signal Co. Ltd.,

62, York Road, London, N.1.

Mention of "The Wireless World," when writing to advertisers, will ensure prompt attention



			<u>OLD PRICE.</u>	<u>NEW PRICE.</u>
GENERAL PURPOSE VALVES				
2v.	4v.	6v.		
PM.1A	PM.3A	PM.5B	10/6	8/6
PM.1HF	PM.3	PM.5D		
PM.1LF	PM.4DX	PM.5X		
PM.2DX		PM.6D		
POWER VALVES				
2v.	4v.	6v.	12/6	10/6
PM.2	PM.4	PM.6		
SUPER POWER VALVES				
2v.	4v.	6v.	15/-	13/6
PM.252	PM.254	PM.256 PM.256A		
SCREENED GRID VALVES				
2v.	4v.	6v.	22/6	20/-
PM.12	PM.14	PM.16		
PENTONES				
2v.	4v.	6v.	25/-	22/6
PM.22	PM.24	PM.26	30/-	27/6
	PM.24A		35/-	30/-
	PM.24B			
A.C. DIRECTLY HEATED VALVES				
AC.104	AC.064		17/6	16/-
SPECIAL VALVES				
PM.13	PM.25	AC.084	25/-	22/6

Mullard
THE MASTER VALVE

Advt. of The Mullard Wireless Service Co., Ltd., Mullard House, Charing Cross Road, London, W.C.2.

A3 *Advertisements for "The Wireless World" are only accepted from firms we believe to be thoroughly reliable.*

RADIO DATA CHARTS

A SERIES OF ABACS

providing most of the essential Data required in Receiver Design.

By R. T. BEATTY, M.A., B.E., D.Sc.

Reprinted from "The Wireless World."

"Radio Data Charts" provide designers of wireless apparatus with a ready and convenient means of solving problems without having recourse to complicated formulæ and mathematics.

By the use of the charts it is possible to tackle all the more familiar problems in radio receiver design; such as, for example, finding the relationship between inductance capacity and frequency, and working out the design of high frequency transformers. All keen amateurs will appreciate this helpful book.

Price 4/6 net. By post 4/10.

(39 CHARTS and more than 50 Diagrams.)

From all leading booksellers or direct from the Publishers.

Published from the Offices of "THE WIRELESS WORLD."

ILIFFE & SONS LTD., Dorset House, Tudor St., London, E.C.4.

W.W.93

WIRELESS DIRECTION FINDING and DIRECTIONAL RECEPTION

(1927)

By R. KEEN, B.Eng. (Hons.)

Second Edition: Revised and Enlarged.

THIS volume deals with the principles of the subject and the constructional details of direction-finding installations, and includes some information concerning aircraft installation. It describes the principles of Direction and Position Finding in this country in such a way that the subject may be grasped easily by engineers tackling this field of wireless work for the first time. Numerous photographs and diagrams are included.

Price 21/- net. By post 21/9

From leading booksellers or direct from the Publishers:

ILIFFE & SONS LIMITED,
Dorset House, Tudor Street, London, E.C.4.

W.W.63

DICTIONARY of WIRELESS TECHNICAL TERMS

(1926)

Compiled by S. O. PEARSON, B.Sc., A.M.I.E.E.
and issued in conjunction with
"THE WIRELESS WORLD."

This volume contains definitions of terms and expressions commonly used in wireless telephony and telegraphy and is intended to serve as a guide to all those interested in wireless who come across, from time to time, unfamiliar words in their reading. In such cases the DICTIONARY OF WIRELESS TECHNICAL TERMS proves of very great use and value. It is well illustrated, and cross-referenced to enable the required information to be rapidly obtained.

Price 2/- net. By Post 2/2

From leading booksellers or from the Publishers:

ILIFFE & SONS LTD.,
Dorset House, Tudor St., London, E.C.4.

W.W.48

Mention of "The Wireless World," when writing to advertisers, will ensure prompt attention.

A4

THE WORLD'S FINEST VALVES REDUCED IN PRICE



*The
amazing*

MAZDA

RADIO VALVES

	NEW PRICE	OLD PRICE
H.210	8/6	10/6
HL.210		
L.210		
H.607		
HL.607		
P.220	10/6	12/6
P.240	13/6	15/-
P.425		
P.625A		
P.625B		
P.650	18/-	20/-
SG.215	20/-	22/6
PEN.230	22/6	25/-
PEN.425		
AC/PEN.	27/6	30/-



THE EDISON SWAN ELECTRIC CO., LTD.
Incorporating the Wiring Supplies, Lighting Engineering, Refrigeration and Radio Business of The British Thomson-Houston Co., Ltd.

Radio Division:
 1a Newman Street, Oxford Street, W.1
 Showrooms in all the Principal Towns

EDISWAN

V.65

"Britain's leading Valves"



— at lower Prices! ”

As from July 18th the undermentioned reductions in the retail prices of certain types of Marconi Valves were brought into effect.

TYPE								OLD PRICE	NEW PRICE	
H 210	HL 210	L 210	H 410	HL 410	L 410	H 610	HL 610	L 610	10/6	8/6
P 215	P 410	P 610	12/6	10/6
P 2	P 240	P 425	P 625	P 625a	15/-	13/6
S 215	S 410	S 610	22/6	20/-
PX 4	PI 240	PI 425	25/-	22/6
PT 625	30/-	27/6

WHEN BUYING VALVES — REMEMBER!

Marconi Valves are used by The B.B.C., Imperial Airways, Empire Communications, Metropolitan Police, Passenger Liners, in fact in almost every important British Service. Remember this when you buy Marconi Valves, you buy British and undoubtedly buy the best.



Marconi Valves

Buy the valves the Experts use!

Mention of "The Wireless World," when writing to advertisers, will ensure prompt attention.

The Wireless World

AND
RADIO REVIEW
(18th Year of Publication)

No. 570.

WEDNESDAY, JULY 30TH, 1930.

VOL. XXVII. No. 5.

Editor: HUGH S. POCKOCK.

Assistant Editor: F. H. HAYNES.

Editorial Offices: 116-117, FLEET STREET, LONDON, E.C.4

Editorial Telephone: City 9472 (5 lines).

Advertising and Publishing Offices:

DORSET HOUSE, TUDOR STREET, LONDON, E.C.4.

Telephone: City 2847 (13 lines). Telegrams: "Ethaworld, Fleet, London."

COVENTRY: Hertford Street.

Telegrams: "Cyclist, Coventry." Telephone: 5210 Coventry.

BIRMINGHAM: Guildhall Buildings, Navigation Street.

Telegrams: "Autopress, Birmingham." Telephone: 2970 and 2971 Midland.

MANCHESTER: 260, Deansgate.

Telegrams: "Iliffe, Manchester." Telephone: 8970 City (4 lines).

GLASGOW: 101, St. Vincent Street, C.2.

Telegrams: "Iliffe, Glasgow." Telephone: Central 4837.

PUBLISHED WEEKLY.

Subscription Rates: Home, £1 1s. 8d.; Canada, £1 1s. 8d.; other countries abroad, £1 3s. 10d. per annum.

Entered as Second Class Matter at New York, N.Y.

As many of the circuits and apparatus described in these pages are covered by patents, readers are advised, before making use of them, to satisfy themselves that they would not be infringing patents.

CONTENTS OF THIS ISSUE.

	PAGE
EDITORIAL VIEWS	95
SCIENCE MUSEUM RECEIVER. BY R. P. G. DENMAN AND A. S. BRERETON	96
DETECTOR DAMPING. BY W. T. COCKING	100
PRACTICAL HINTS AND TIPS.	103
BROADCAST RECEIVERS REVIEWED. EAGLE "ALL-IN TWO"	105
CURRENT TOPICS	106
WIRELESS THEORY SIMPLIFIED. BY S. O. PEARSON	207
BROADCAST BREVITIES	110
LABORATORY TESTS ON NEW APPARATUS	111
CORRESPONDENCE	112
READERS' PROBLEMS	113

BROADCAST PROPAGANDA.

A READER, Mr. Bertram Munn, who contributes to our Correspondence columns in this issue, has a good deal to say on the subject of advertising through the microphone, and he makes it quite clear that he is a strong supporter of the sponsored programme, not presumably because he likes advertising thrust upon him, but because he wants better programmes. His view is briefly summed up in the final sentence of his letter: "What is an occasional jar from an advertisement compared with the present chronic irritation caused by mediocre programmes?"

If one could see that by permitting advertising in broadcasting we should at once effect a cure for all the shortcomings for which our present programmes are blamed, then we think that the idea of advertising by the microphone and sponsored programmes would deserve closer investigation. But what guarantee have we that, even if we were to hand over broadcasting so that every programme became a sponsored programme,

the satisfaction of the public would be any the greater? The B.B.C. has ample funds available for the compilation of the programme matter, and we doubt very much whether what various sections of the public choose to describe as the "poor quality of the programmes" is in any measure due to lack of funds. The B.B.C. is in a position to gather around it better talent, and more of it, than the organisers of any independent sponsored programme could hope to find, and the absence of outstanding artistes from microphone programmes is far more often due to contracts which prevent them from broadcasting than to lack of sufficient funds with which to remunerate them for their services.

Where Advertising may be Justified.

If we make any exception in the matter of advertising by the microphone, then let us see to it that it is put to a useful purpose. The B.B.C.'s service does not require to be subsidised by revenue from advertising. Those who very wisely established the constitution and organisation of our broadcasting service in the first place made provision for meeting the cost of broadcasting out of licences, and their intention at the time was to preclude the necessity for the service to have to look elsewhere for funds. But if we review the position with regard to a short-wave Empire Broadcasting Service we may then find that the situation is different: for funds are not yet available for the service, nor is there any simple machinery possible which would ensure collection of the necessary revenue from those who will make use of the service. We are therefore prompted to think that advertising in some suitable form may not only solve the problem of meeting the cost of an Empire Broadcasting Service, but may, at the same time, serve a very useful purpose in stimulating Empire trade. We have previously put forward this suggestion when discussing the question of funds for 5SW in our issue of November 6th, 1929. On that occasion we made the proposal that the Empire Marketing Board might be considered as an authority on whom the task of financing the short-wave service might be imposed. This authority, we explained, has as its object the development of trade within the Empire, and we contended that there could be no objection to the Empire Broadcasting Service being utilised to help in such an object as the stimulation of inter-Empire commerce. We expressed the view then, which we still maintain to-day, that no one would quibble at the Empire Broadcasting Service being put to such a use as this, particularly when by this means the problem of funds for programmes and stations might be solved.

SCIENCE MUSEUM RECEIVER

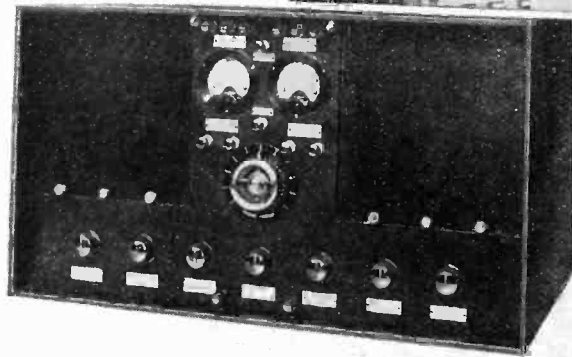

By

R. P. G. DENMAN,
A.M.I.E.E.,

and

A. S. BRERETON,
M.A.

Details of an Equipment
Designed for Purposes of
General Reference.

IT is now five years since one of the authors first proposed the erection at the Science Museum, South Kensington, of a broadcast receiver which by reason of careful design and strict maintenance might come to be regarded as a standard of reference from the point of view of fidelity in reproduction. The power and size chosen for this purely local-station receiver contrasted rather strikingly with the battery-driven sets then in common use, but the fact that, thanks to the development of mains equipment, there are now quite a number of commercially manufactured sets having a distortionless output of like magnitude should dispose of any suggestion that the power was excessive. It was, indeed, entirely insufficient to secure that ideal condition which the authors have kept before them in designing the receiver which is presently to be described. This is that no link in the chain between aerial and loud speaker shall be allowed to become overloaded until the intensity of the sound reaching the listener is greater than it would be if he were hearing the original performance.

Usually in receivers it is necessary to restrict the volume to some lower level at which the last stage (or perhaps the penultimate stage) is just not overloaded, but by assigning conservative engineering values throughout the set it is possible (though with some difficulty) to shift the onus of responsibility for overloading on to even the largest loud speaker that may be connected to it. This, in the present case, is a moving-coil unit with a 27ft. logarithmic horn having a lower cut-off frequency of

32 cycles per second,¹ designed for use with a 555W unit and a special equaliser arrangement.

The first step in the design of the new receiver was to settle the output power, and this was ultimately fixed at 40 watts. Since the safe power-handling capacity of the 555W unit is about 13 watts this might be thought excessive, but efficiency is a secondary consideration in the design of a large output transformer which is to have a good frequency characteristic, and subsequent tests have shown that only about 10 watts are actually transferred to the horn unit. Assuming that the efficiency of this unit is 25 per cent., the maximum acoustic output is about 2.5 watts, equivalent (since an average singer develops a peak power of 15 milliwatts) to a mixed choir of 150 voices.

Some difficulty was experienced in obtaining output valves and suitable rectifiers for 40 watts. The valves chosen for the output stage are at present only manufactured in the United States, but it is understood that they will soon be made in this country by the B.T.H. Company. They call for an anode potential of 1,000 volts and a grid swing of ± 150

volts, under which conditions they are capable of giving an output of 20 watts with 5 per cent. harmonic distortion.

The design of a penultimate stage which will deliver the required grid swing to these valves is evidently a matter requiring some care, and as no indirectly heated cathode valves now made will accomplish this without

WITH the praiseworthy object of demonstrating the possibilities of high-quality broadcast reproduction, the National Science Museum authorities installed, in the autumn of 1925, a receiver representing the most advanced design of its time. This is about to be replaced by a more up-to-date set, in which push-pull power grid detection replaces a diode rectifier. To preserve the side-bands of the modulated transmission the single H.F. stage contains filter circuits giving a flat-topped resonance curve, whilst fidelity of reproduction in the L.F. amplifier is maintained by the use of a paraphase amplifier.

¹ See *The Wireless World*, July 31st, 1929, p. 97.

Science Museum Receiver.

themselves becoming overloaded it has been necessary to employ filament-heated valves (L.S.5) at a high anode voltage.

After some further consideration of the low-frequency amplification stages the authors decided to adopt the valuable "Paraphase" scheme of connection patented by Mr. R. E. H. Carpenter.²

The Paraphase Amplifier.

In this two separate amplifying chains are used, the input to the second chain being derived from the first anode circuit of the main chain. This virtually produces a 180-deg. phase difference between opposite anodes and grids throughout the amplifier, so that if the valves are well matched and the proper adjustments made, certain unwanted additions to the original signal, e.g. hum components and second harmonics originating within the amplifier, give rise to opposing E.M.F.s in the two chains and are automatically cancelled in the output transformer; while the signal voltage proper, which is applied in opposite phase to each chain, produces an additive effect.

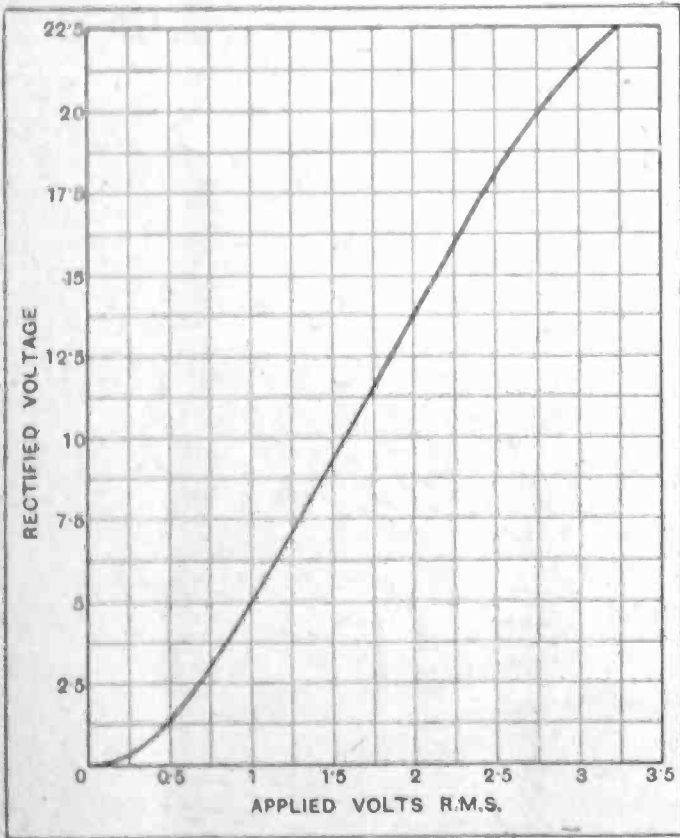

Fig. 1.—DETECTOR CHARACTERISTIC. Mullard 164 V. External anode resistance 6,000 ohms; Anode voltage 278; Steady anode current 16 mA.

² British Patent Specification No. 325833. See also F. Aughtie, "Push-pull Amplification," *Experimental Wireless and Wireless Engineer*, June, 1929, p. 307.

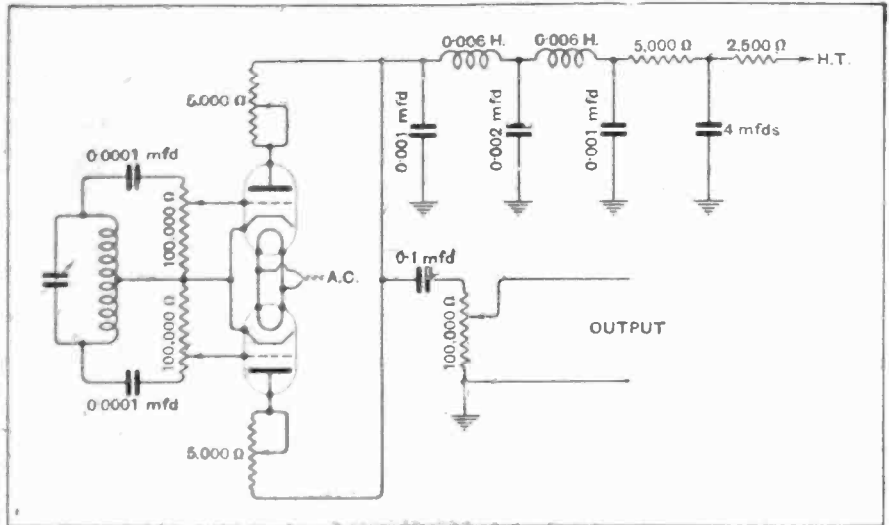

Fig. 2.—Push-pull detection with Campbell low-pass filter.

A receiver so connected combines the advantages of phase-opposition working (push-pull) with those of resistance-coupling. As regards the former, a pair of output valves connected in push-pull will deliver about twice as much power to a loud speaker (for the same amount of harmonic distortion) as will the same two valves connected in parallel, provided that they are well matched. As regards the latter, comparative tests carried out by the British Broadcasting Corporation with resistance-capacity and transformer-coupled amplifiers having identical frequency-response characteristics leave no doubt whatever that audible distortion can be produced by one or more transformers,³ and there is definite evidence that a marked improvement in quality will be observed when means have been found to preserve, throughout the broadcast system, a constant value for the expression

$$\frac{d\alpha}{d\omega}$$

where α is the phase angle of any modulation component of frequency $\frac{\omega}{2\pi}$

Push-pull Power Grid Detection.

Before the design of the low-frequency amplifier could be proceeded with it was necessary to settle the problems of the detector stage. The advantages of anode-bend "Power" detection had been pointed out by several writers, but in the course of their experiments the authors failed to discover any indirectly heated valve which was satisfactory for anode-bend detection, and it seemed clear to them that such detectors could

³ In the B.B.C. tests various amplifiers having identical steady-state characteristics were included between a microphone and a loud speaker, and the quality compared on noise, speech, piano and xylophone. The paraphase amplifier was unquestionably the best. A straightforward resistance-capacity amplifier without iron, except in the output components, came second. The least satisfactory arrangement was a resistance-capacity push-pull amplifier with input and output transformers, these latter being choke-capacity coupled. It is to be noted that this last arrangement is (at present) standard in the B.B.C. control rooms.

Science Museum Receiver.—

gives time for the filaments to heat up before the high-tension voltages are applied. The early stages of the set are supplied with current at 480 volts through an ordinary two-wave rectifier and smoothing circuits. For the final stages a pair of hot-cathode mercury recti-

fiers are used, the transformer being wound to give 1,200 R.M.S. volts. Metal rectifiers are used for the detector heaters and for the low-voltage winding of the large horn loud speaker, a special equaliser for which was worked out and presented to the Museum by Standard Telephones and Cables, Ltd.

(To be continued.)

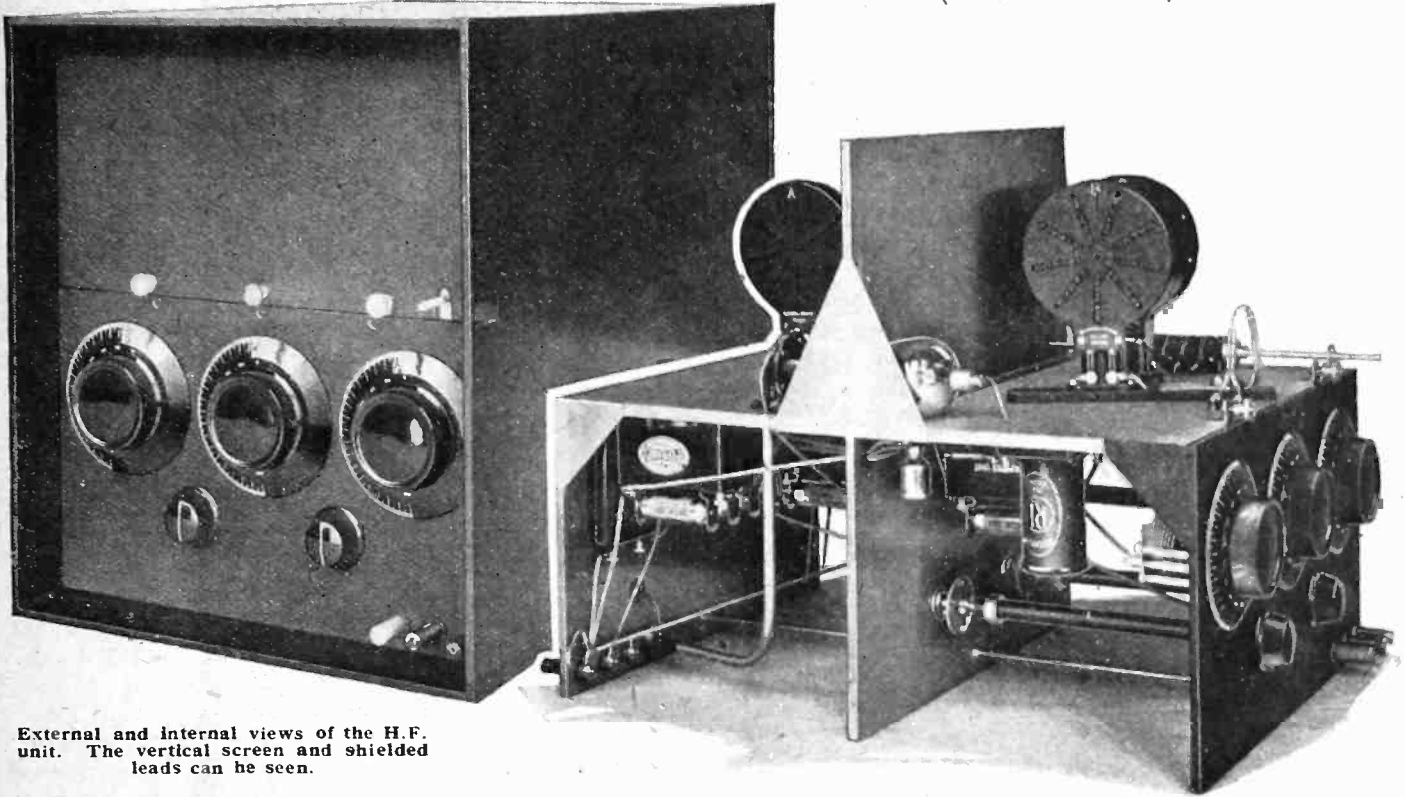

External and internal views of the H.F. unit. The vertical screen and shielded leads can be seen.

14-megacycle Waveband.

News from Ceylon states that reception conditions on 21 metres were very patchy during the week ending June 28th. Great Britain came through only at intervals and fading was much in evidence. Among the stations heard were G5WT, G5VP, G2OL, and G2NM.

o o o o

British Arctic Air Route Expedition.

The Expedition bound for Greenland in Shackleton's historic ship "Quest," which sailed from London on July 6th, expects to set up base camps about the middle of August, one on the south-eastern coast of Greenland and the other 150 miles inland. The call-sign of the Expedition is GKN, and the wireless operator has arranged a regular schedule with G2CW, of Bath, nightly at 22.00 B.S.T.

The object in view is to establish an all-British air route across the Arctic regions to Canada, and the equipment includes aeroplanes, fast motor boats and sledges. From the central base exploring parties in dog sledges will journey northward, southward, and to the coast.

The meteorological section of the Expedition intends to remain at the main base for a whole year, this being the first time that an Expedition has spent

TRANSMITTERS' NOTES.

a winter at such a high altitude in the Arctic. According to news lately received the party has reached the Faroe Islands, where dog teams are being embarked.

o o o o

Transmissions from Bangalore.

Dr. H. E. Watson (VU2BF), of the Indian Institute of Science, Bangalore, transmits on Sundays at 12.30 and 9.30 p.m. Indian Time (05.30 and 14.30 B.S.T.) on 75 metres. Before starting his telephony he sends I.C.W. for five minutes to enable listeners to tune in. He will welcome reports.

o o o o

Picking up the "Southern Cross."

Mr. H. B. Old was indefatigable in picking up messages from the "Southern Cross" during the monoplane's recent flight across the Atlantic. For over 30 hours he remained at the short-wave receiver in his station G2VQ, at Mapperley, Nottingham, taking down messages transmitted by Mr. Stannage, the wireless operator, some of which were communications to his parents living near

Melton Mowbray, who, on the arrival of the "Southern Cross" in New York, were able to listen, at G2VQ, to their son speaking over the microphone after landing.

o o o o

International Short-wave Radio League.

A society of short-wave listeners has recently been formed in U.S.A. "to create international friendship through the short-wave medium and to bring the short-wave listeners, clubs and experimenters, in all corners of the globe, into one big family."

The official organ of the Society, "The Short-Wave Searcher's Guide," is to be issued quarterly, beginning next September, while supplements containing the latest changes of wavelengths, new calls, etc., will from time to time be issued to members. The annual subscription is \$1.75, and full particulars may be obtained from the Hon. Secretary, Mr Clifford Daly, Jamaica Plain, Boston 30, Mass.

o o o o

New Call-signs and Changes of Address.

- G6NZ L. E. Newnham, 18, Baffins Rd., Copnor, Portsmouth. (Change of address.)
- 2AAL F. L. Postlethwaite, 41, Kinsfauns Rd., Goot-mayes, Ilford, Essex.
- 2ACK V. A. Sims, 29, Rochford Ave., Westcliff-on-Sea.

DETECTOR

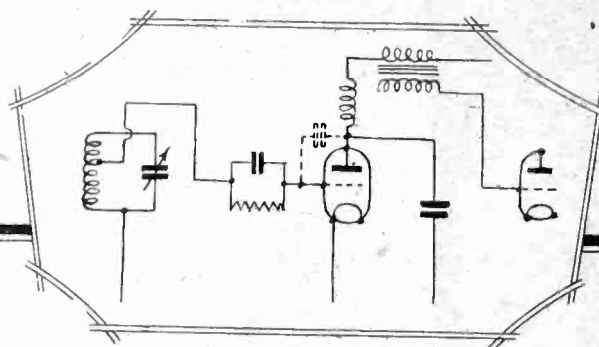

DAMPING

Measuring the Load Imposed by the Power Grid Detector.

By W. T. COCKING.

It has recently been shown in these pages that the power grid detector¹ has characteristics more linear than those of any other rectifier, with the exception of the diode. As it is also the most sensitive method of detection, it is the most suitable for general use in high-quality receivers. In common with all grid detectors, however, it imposes a considerable damping upon its tuned input circuit, and it becomes of importance to determine the magnitude of this damping under ordinary conditions, and to find means for its reduction.

A tuned circuit is affected in two ways by the grid detector. In the first place, the internal grid A.C. resistance of the valve is in parallel with the circuit, thus increasing the effective H.F. resistance and reducing the efficiency. A more serious cause of damping, however, is the effect of the anode circuit of the valve upon the grid circuit. It is not always realised that the normal constants of the tuned grid circuit may be profoundly modified by the nature of the anode circuit load impedance. It has been shown by W. I. G. Page² and W. B. Medlam³ that the anode bend detector damps its input circuit because of the grid-anode inter-electrode capacity of the valve, and this is also true of the grid detector.

High-frequency currents appear in the anode circuit of the detector, and flow through the anode circuit H.F. load impedance, which is usually the by-pass condenser. The reactance of this condenser is usually sufficiently high to allow an appreciable voltage to be developed across it. This voltage causes a current to flow through the grid-anode inter-electrode capacity of the valve, and a voltage to appear at the grid. Now the magnitude of this voltage depends upon the valve constants, including the grid-anode capacity, and upon the value of the anode circuit load impedance; but its effect depends upon

the phase of the feed-back voltage, which is governed by the nature of the anode circuit load impedance.

With an inductive load impedance the feed-back is in phase with the applied H.F. voltages, and regeneration occurs; and, under suitable conditions, oscillation. The usual load impedance in the anode of a detector, however, is capacitive, and the feed-back is then out of phase with the applied voltages, and anti-regeneration occurs, with damping of the input circuit. The magnitude of the feed-back is governed by the high-frequency amplification of the valve, and by the capacity of the condenser formed by the valve electrodes. This accounts for the fact that, other things being equal, feed-back is smaller with an anode bend detector than with a grid

detector; for in the former case the anode A.C. resistance is of necessity much higher, with a consequent lower H.F. amplification.

Now the effects of this feed-back are most easily expressed as an alteration in the effective H.F. resistance of the tuned circuit. Just as the effects of reaction are expressed as a reduction in the H.F. resistance, so may the effects of anti-phase feed-back be expressed as an in-

crease in this resistance. It must not be forgotten, however, that a tuned circuit, the resistance of which is thus artificially altered, may not always behave in exactly the same manner as a circuit which has as a natural constant the same value of resistance.

In order to determine the magnitude of the losses likely to be experienced in practice with power grid detection, the writer carried out a series of measurements on the Mazda AC/HL valve. The circuit used is shown in Fig. 1; a valve voltmeter was connected across the tuned input circuit to measure the H.F. voltage applied to the detector, while a milliammeter in the detector anode circuit recorded the change of anode current due to rectification. A 0.0001 mfd. grid condenser with a 0.15 megohm leak were used, and the steady no-signal anode current through a 20,000 ohms anode resistance was kept constant at 8.5 mA. A low-frequency amplifier was added to give an audible check on results. In

SINCE its first description a few weeks ago the Power Grid Detector has become very popular. The benefits of distortionless output and high sensitivity have been well appreciated, but the loading of the preceding tuned circuit is a disadvantage. In this article, as a result of actual measurement, the interesting conclusion is reached that the damping due to grid current is almost negligible, whereas that due to the reverse reaction brought about by the anode-grid capacity of the valve is of large magnitude. Various methods of combating the ill-effects of this form of loading are described.

¹ "Power Grid Detection." *The Wireless World*, May 7th, 1930.

² "The Valve as an Anode Detector." *The Wireless World*, March 13th and March 27th, 1929.

³ "Improving Detector Efficiency." *The Wireless World*, May 22nd, 1929.

Detector Damping.—

taking the curves the coupling to the source of H.F. current was kept constant, and the H.F. grid voltage and anode current change were noted for different values of the by-pass capacity C. It was found that with a large H.F. input misleading results were obtained, owing to the detector becoming overloaded. An average value, therefore, was chosen for the input, as most nearly representing practical conditions.

The results are shown in the curves of Fig. 2, in which curve A shows the variation in H.F. input R.M.S. voltage, and curve B the variation in detector anode current change, for various values of by-pass capacity. It will be noted that the larger the capacity of the condenser the greater is the input voltage, indicating lower damping of the tuned circuit, due to smaller feed-back. The curve for anode current change is almost parallel

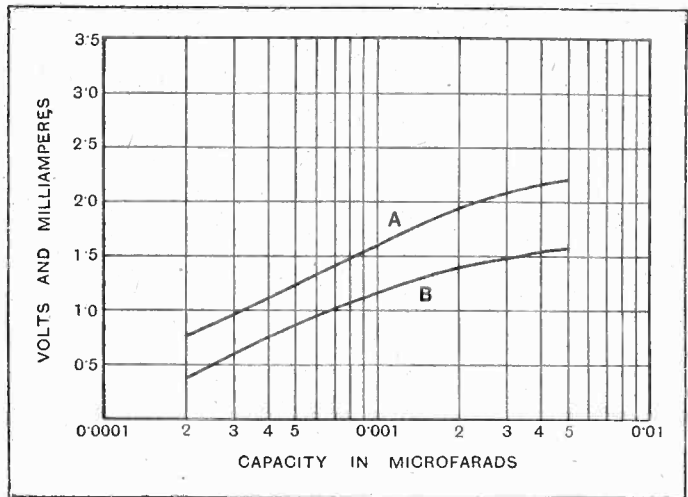

Fig. 2.—In curve A the variation in H.F. input voltage with change of by-pass capacity is shown. Curve B shows the variation in anode current change with change of by-pass capacity.

A.C. resistance was about 200,000 ohms; a much better figure than was anticipated from an inspection of the valve characteristics.

The Effect of a Larger By-pass Condenser.

The effective series resistance added to the tuned circuit by feed-back alone could then be calculated, and this is given in curve A, of Fig. 3, while curve B shows the total series resistance of the circuit. It will be seen that the resistance added by anti-phase feed-back is very serious when a small capacity by-pass condenser is used. With a 0.0002 mfd. condenser, the resistance added by feed-back alone is 127 ohms, while even a 0.001 mfd. condenser introduces some 40 ohms resistance into the circuit. If the anode resistance be 20,000 ohms or less, however, it is quite permissible to use a larger by-pass

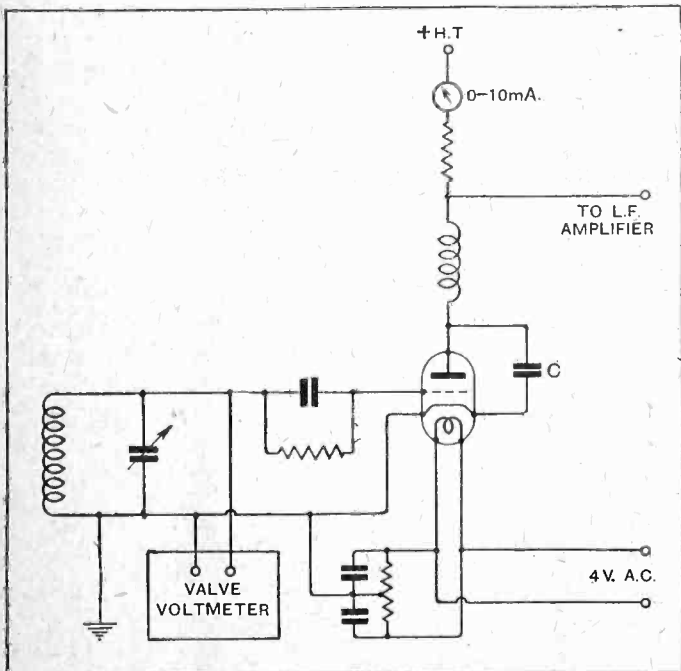

Fig. 1.—The circuit used for the experiments in connection with the calculation of the input load imposed by the power grid detector..

with that for input volts, which shows that the rectification efficiency is almost constant. With capacities higher than about 0.002 mfd., however, the change of anode current is not quite proportional to the input, as the detector is slightly overloaded with the larger input given by this value of capacity.

Although these curves show the reduction of input due to feed-back, they do not show the apparent increase of H.F. resistance of the tuned circuit. In order to obtain figures for this, the H.F. resistance of the coil, including the damping due to the valve voltmeter and the AC/HL valve base and holder, was measured and found to be about 25 ohms at 250 metres. The grid A.C. resistance of the valve was then determined by connecting a 1 mfd. condenser between the anode and cathode to reduce feed-back to a negligible amount, and re-measuring the tuned circuit resistance. The coil H.F. resistance was then found to be some 36 ohms, showing that the grid

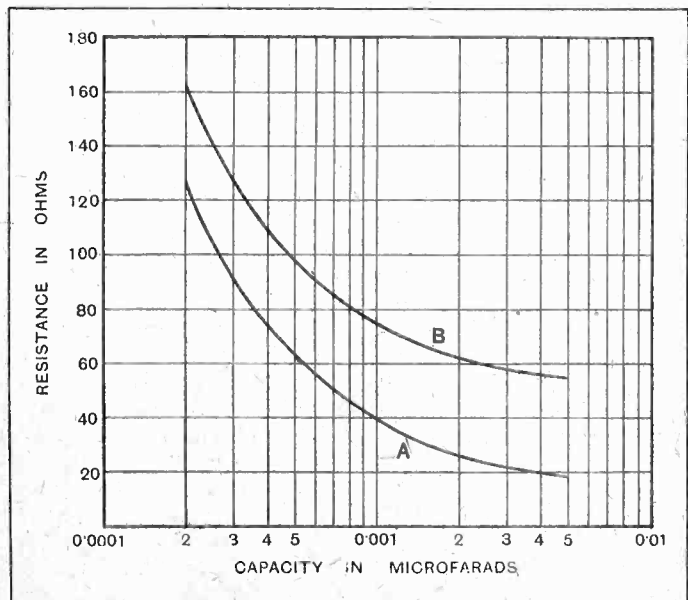

Fig. 3.—The increase of circuit resistance due to feed-back alone is given in curve A, while curve B shows the total series resistance of circuit including all valve damping.

Detector Damping.—

capacity than this; and a 0.002 mfd. condenser, which adds only 25 ohms resistance to the grid circuit, is quite satisfactory from the point of view of quality.

The same results are shown in Fig. 4, but they are expressed as an equivalent resistance connected in parallel with the tuned circuit, as this is more convenient when designing a high-frequency amplifier. Curve A shows the losses introduced by feed-back alone, while curve B indicates the total losses due to the detector.

It is obvious that the most effective method of eliminating this damping would be the elimination of the feed-back itself; and the best method of doing this would undoubtedly be the use of a screen-grid valve. Unfortunately, however, the ordinary screen-grid valves have unsuitable characteristics; and, pending the development of an entirely new type of valve, we must look for improvement in other directions. Two methods exist, and these were explained in some detail in the

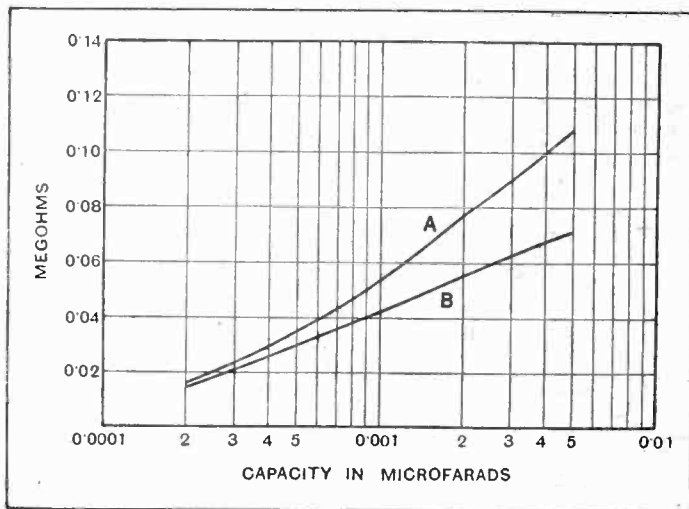

Fig. 4.—Equivalent shunt resistance due to feed-back alone (curve A) and equivalent shunt resistance due to all detector losses (curve B).

two articles on anode-bend detection already referred to—neutralising, and the use of a series resonant output circuit. The former has the disadvantage of a coil tapped at its centre—a point which may not coincide with the optimum tapping for reduction of loading. The alternative is to connect a series resonant circuit in place of the usual by-pass condenser; but this has the disadvantage of adding another tuning control to the set, and a control which adds to the selectivity only in so far as it reduces damping.

In practice, the most satisfactory method of reducing damping is to connect the grid lead of the detector, not to the top of the tuned circuit in the usual manner, but to a tapping on the coil. The exact position of the tapping can easily be found by experiment, but a position such that two-thirds of the coil is included in the grid circuit is usually satisfactory.

The damping, however, is not as serious in practice as would appear from an inspection of the curves illustrating this article. The numerous stray reactions always present in an H.F. amplifier reduce the damping to a considerable extent. In any case, the selectivity

can be made considerably higher than that with an anode-bend detector by the simple process of adding an extra tuned circuit, preferably in the form of a band-pass filter. Where H.F. amplification is not used, the damping is of little importance, since its effects can be entirely removed by the application of reaction; and where this is considered undesirable, an extra tuned circuit is again indicated. It is thought that the better quality and the higher sensitivity of the power-grid detector are well worth a small sacrifice in selectivity, when this last can so easily be made up by the addition of one extra tuning coil and condenser.

o o o o

A FIRST ELECTRICAL THEORY FOR SCHOOLS.¹

By H. W. HECKSTALL-SMITH.

This is a school text-book which leaves with the reader two vivid and all too rare impressions. One is that the author is interested in teaching not only the elements of electricity and magnetism, but also the elements of the right way to think scientifically; the other is that he dares to think it no crime to learn and smile at the same time. This does not mean that he wastes time lecturing on "The Correct Attitude towards Science" or making jokes. The fact that in the compass of less than 290 pages he starts from scratch (or, rather, our old friend Gilbert rubbing his familiar piece of amber) and ends with the equation for calculating the frequency of an X-Ray, shows pretty clearly that no time or space is frittered away. And in those comparatively few pages he seems to neglect nothing that deserves attention; the merry but short life of the average H.T. accumulator when charged at three amperes at the local garage is dealt with; even the possibility of the earth's magnetism being due to electron-currents in the upper atmosphere is discussed, and the reflection of wireless waves from the Heaviside layer—but is not 20 miles rather low, even for the lowest layer?

Indeed, the reviewer was left with the uncomfortable feeling that he himself must have wasted time at school to an appalling extent when he realised that in the 334 pages which comprise the book, with its introduction, appendices and sets of questions, and which give the impression (no doubt erroneous) that they would easily be mastered in a month or two, the author covers all the material needed for the electrical questions in the entrance examinations to Universities, the First M.B., and (for candidates not taking higher mathematics), in Schedule A of the Army Examination; or, as he says, goes "probably as far as one can go without a knowledge of differential and integral calculus."

The words just quoted bring one back to that vivid impression of the rightness of the author's methods. Taking one aspect alone: although the most complicated mathematics demanded throughout the whole book is probably the bit of simple algebra on page 165, the reader is never allowed to forget that his next job, if he wants to go on from strength to strength, is to work up his "maths."—which (he will feel) he can no longer keep in its watertight compartment as a subject quite distinct from "stinks," since it is so obviously a tool needed by the physicist or engineer at every turn. In fact, the reviewer can easily picture some keen young enthusiast, half-way through the book, surreptitiously searching his parents' bookshelves at half-term for the wherewithal to acquire this invaluable tool—and fortunate he will be if he finds it in that unique little book, "Calculus Made Easy," by "F.R.S." For Professor John Perry's methods would seem admirably suited to carry on the good work here begun by the Physics Master at Stowe School; the two authors, indeed, seem to have much in common—including a healthy hatred for pomposity and obscurantism. Take, for example, a quotation from the book under review: "If zinc is put in dilute sulphuric acid, there exists a tendency for zinc atoms, positively charged, to leave the zinc and go into solution. That entirely unsatisfactory, and even ridiculous, statement is all that the average person is likely to get as an explanation, without a very great deal of trouble." That, surely, might have been written by the great "F.R.S." H. D.

¹ Published by Dent and Sons, Ltd. Price 4s.

Practical Hints & Tips

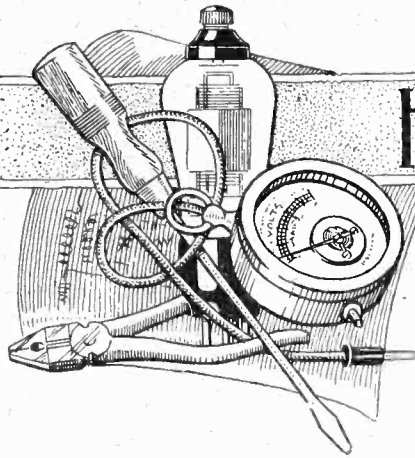

CHOOSING S.G. VALVES.

In making a choice of ordinary triode valves one is influenced by such factors as economy in filament consumption, mutual conductance, and by their reputation as to longevity. In dealing with screen-grid high-frequency valves the same things should be taken into account, but it must not be forgotten that completeness of internal screening is a matter of great importance; unless the precautions taken to reduce anode-grid capacity to the lowest possible figure are adequate, it will be impossible to attain a very high H.F. gain, however good the "figure of merit" of the valve may be when judged by ordinary standards.

ALTERNATIVE AERIAL SYSTEMS.

There are several ways of coupling tuned aerial and secondary circuits, each with its own advantages and disadvantages in the matter of efficiency, convenience, and economy; it is probably true to say that all the schemes applicable to broadcast receivers have been discussed at some length in the pages of this journal. As far as results are concerned, there is not a great deal to choose between the various methods, but it should perhaps be pointed out that the various practical designs that have been put forward may roughly be divided into two main groups.

In the first group we have the fully tuned aerial system, generally with a variable or semi-variable series condenser for improving selectivity, and also for extending the band of wavelength covered by a single inductance coil; this arrangement is shown in Fig. 1 (a). Under average working conditions it is generally the best, when judged purely by signal strength, but has the disadvantage that it is almost impossible to arrange matters so that the aerial tuning condenser remains sensibly "in step" with that shunted across the secondary inductance.

Simplified Aids to Better Reception.

This disability can be overcome by providing an "aperiodic" coupling between the aerial and its coil in the manner shown in Fig. 1 (b). As ordinarily operated, this circuit should be definitely more selective than the other, but its adoption will generally result in rather weaker signals—especially if aerial coupling be reduced well below the optimum in order to maintain synchrony between the tuning condensers.

Needless to say, the (b) arrange-

ment is essential when the tuning controls are to be ganged, and consequently is always to be found—though perhaps in modified form—in input filters with fixed coupling whether capacitative or magnetic.

SENSITIVE ANODE BEND DETECTION.

When sensitivity is the first consideration, it by no means follows that the modern type of low-impedance detector will yield best results when used on the anode bend principle, and followed by resistance coupling. Generally speaking, the best all-round performance, combined with effective detection of weak- or medium-strength signals, will be afforded by an efficient valve of fairly high impedance—from 20,000 to 30,000 ohms or even more.

A valve of this type would generally be used with an anode resistance of up to a quarter of a megohm; this value cannot be greatly exceeded without risk of impairing the reproduction of high notes.

When planning a sensitive receiver of the type under consideration, it is hardly possible to better the values used in the "1930 Everyman Four": valve impedance, 25,000 ohms, with an amplification factor of about 25; anode resistance, 250,000 ohms; anode by-pass condenser, 0.0003 mfd. These constants were chosen with a view to effecting what is generally regarded as the best possible compromise between the conflicting claims of detector efficiency, high-note loss, grid circuit loading due to reverse reaction effects, and the separation of H.F. and L.F. components in the detector anode circuit.

High-efficiency valves with impedances of from about 7,000 to 12,000 ohms have a theoretical advantage where quality is the first consideration, largely because it is possible to operate them effectively with a comparatively low value of anode coupling resistance.

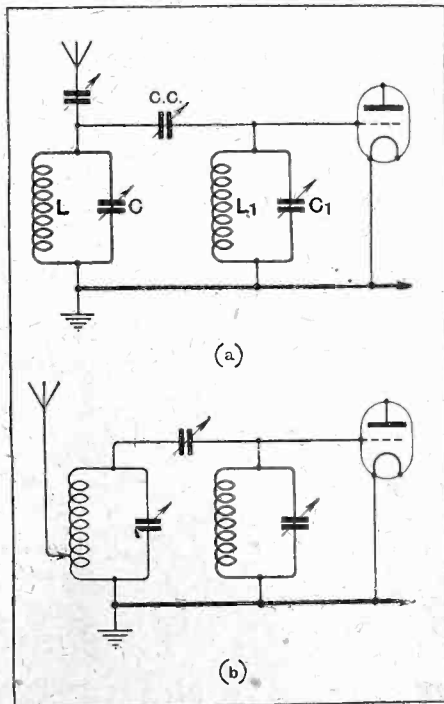

Fig. 1.—Fully tuned and "semi-aperiodic" aerial systems in conjunction with a two-circuit tuner. L, aerial inductance; L₁, secondary inductance; C, aerial condenser; C₁, secondary condenser; C.C., coupling condenser.

A PRACTICAL INTER-VALVE COUPLING.

In this section of *The Wireless World* of July 9th it was pointed out that the Hartley detector circuit, with throttle-controlled reaction, is suitable for use in conjunction with a power grid rectifier. Casual mention was made of the fact that this arrangement can equally well be used as an inter-valve coupling in sets with H.F. amplification as in simple receivers with an unaided detector; it occurs to the writer that it may not be immediately obvious how connection should be made when there is a preceding H.F. stage.

The use of this inter-valve coupling in the form of a double-wound transformer is almost ruled out in practice by the difficulty of arranging the primary winding so that it may be properly coupled to both long- and

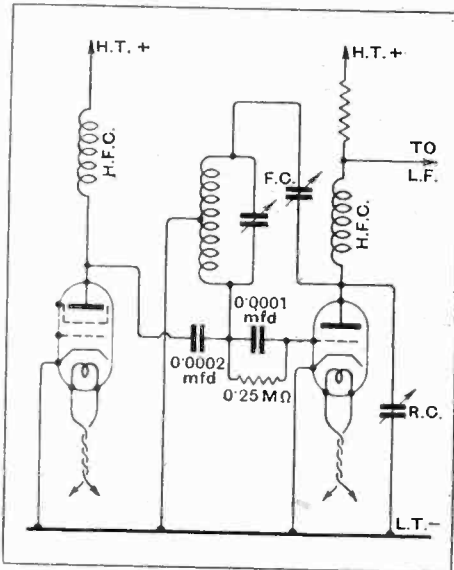

Fig. 2.—Hartley circuit inter-valve coupling between an H.F. valve and a power grid detector.

short-wave sections of the secondary coil, and to avoid all difficulties of this sort it is strongly recommended that the parallel feed or tuned grid method should be adopted in the manner suggested in Fig. 2. A consideration of this diagram will show that only one-half of the tuned inductance is in parallel with the preceding anode choke, and so the whole arrangement is more or less comparable with a 2:1 ratio step-down transformer; generally speaking, it will provide stability even when absolutely complete screening of input and output H.F. circuits is not included. This does not mean, how-

ever, that reasonable precautions should not be taken.

The diagram given in Fig. 2 does not show any provision for wave-band switching, as it merely indicates the general scheme of connections; where both medium and long broadcasting wave-bands are to be received it is generally most convenient to make provision for "loading" the tuned inductance at its centre point in the conventional manner. This is shown in Fig. 3, in which L is the centre-tapped long-wave winding, which may conveniently be a commercial coil with about 200 turns. The remaining coils are merely the two halves of the medium-wave grid inductance, which is split at its centre point.

A MISLEADING EXPRESSION.

We have all slipped into the habit of referring to "free" grid bias, and are perhaps inclined sometimes to forget that in an art such as ours everything has its price.

Of course, apart from the initial cost of components used in providing a conventional scheme for automatic bias, the price paid is assessed in terms of lost H.T. voltage; in other words, each grid volt is obtained by sacrificing an anode volt. These volts can generally be spared, but the matter must clearly be taken into account when legislating for the supply of, let us say, an L.S.5A, which requires grid negative to the extent of over 100 volts.

BROKEN BIAS CONNECTIONS.

Many readers seem to have been puzzled by the behaviour of receivers fitted with free grid bias, or with grid bias eliminators; in carrying out tests or adjustments of sets of this kind it is not infrequently observed that the anode current of a valve, as indicated by a milliammeter, does not undergo any appreciable change when the grid return lead joined to its bias resistance is momentarily broken. Now it is well known that standing anode current should vary in sympathy with changes of grid bias, and the effect noted above may lead one to form an opinion that the grid voltage supply device is inoperative.

In actual practice, however, this is not always the case. The grid circuits of receivers deriving their

bias from the mains are almost invariably "decoupled" with fairly large resistances and condensers of considerable capacity; these condensers become charged to the working potential of the grids, and, if insulation throughout happens to be of a high order, they will retain their charge for an appreciable period of time, with the result that the operating conditions of the valve may remain sensibly unchanged, even though the bias feed circuit is interrupted.

It will therefore be clear that this effect indicates efficiency rather than inefficiency, although it should be made clear that a slight leakage, of sufficient magnitude to allow the condenser to discharge itself in a few seconds, will generally do no harm.

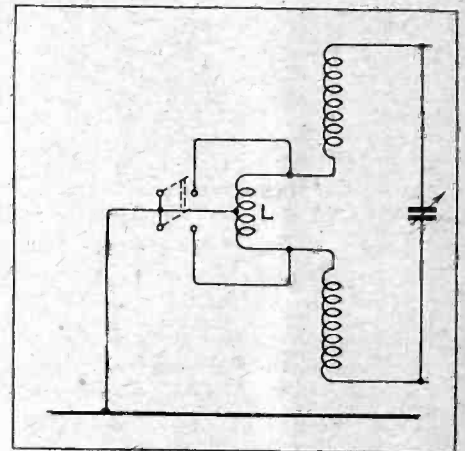
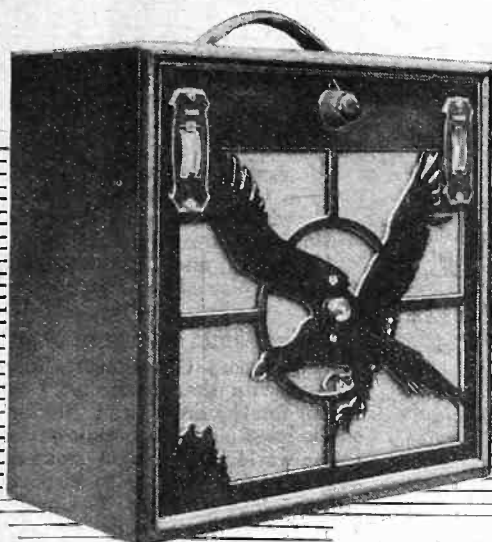

Fig. 3.—Modifying the circuit of Fig. 2 for long-wave reception.

POWER TRANSFORMERS.

Several designs for the home construction of power transformers have been published in this journal, and where an output of 4 volts for the heaters of indirectly heated A.C. valves has been provided, it has been usual to specify a winding capable of delivering 3 amperes—and accordingly intended primarily for feeding a three-valve set.

A fair margin of safety is always allowed, and the output would be adequate enough for feeding four valves without undue drop in voltage or overheating. However, when it is intended that the rated consumption is to be exceeded to this extent, it is as well, for the low-tension winding, to substitute the next heavier gauge of wire for that specified.



BROADCAST RECEIVERS REVIEWED

EAGLE "ALL-IN-TWO"

A Self-contained Detector-pentode
Two valve Receiver.

ONE often wonders how many listeners have sets which are, like the motor car of the classic advertisement, "too powerful for owner." A reasonable reserve of sensitivity is all to the good, but it really does seem rather ridiculous to use a five-valve set with two H.F. stages almost exclusively for the reception of a local station some few miles away. In such cases an appreciable amount of money is expended on the maintenance of valves which are rarely, if ever, called upon to do any useful work.

The set under review is primarily intended to operate on its self-contained frame aerial at a strictly limited distance from a transmitter. To cater for those who require occasional long-range reception, special provision is made for connection of an external aerial-earth system, which more or less takes the place of several expensive valves which would normally be unprofitable passengers. Alternatively, the receiver may be regarded as being a simple detector-pentode combination which is completely self-contained except for the connection of an external aerial and earth.

Its circuit arrangement embodies a grid detector joined directly across the tuned frame aerial, which is divided into two sections, one of which is short-circuited for medium-wave reception. There is capacity-controlled reaction between grid and plate circuits of this valve; the

feed-back condenser is large enough for efficient detector operation.

As is to be expected in a design of this sort, the rectifier is coupled to the pentode by an L.F. transformer. The maximum available H.T. voltage of 90 is applied to both anode and screen of the output valve, but provision is made to feed the detector anode with a lower pressure. The loud speaker is directly connected, and has a fairly large by-pass condenser.

Construction is on conventional "transportable" lines, the receiver being housed in an upright oak cabinet measuring 15in. wide, 7½in. deep, and 14½in. high. The Chakophone-Colossi loud speaker is mounted in the lower part of the container, its adjusting knob being passed through the front, on which are also mounted the edgewise condenser dials; these, it is noted, are recessed sufficiently to prevent the possibility of their being damaged in transit. The remaining control is a combined filament-waveband switch.

In the instructional pamphlet issued by the makers it is stated that the set, when working on its frame aerial, should have a range of 25 miles; tests made in several localities would seem to show that this is a fair estimate of its capabilities in this direction under average conditions. True, signals are obtainable at considerably greater distances, but only at the expense of quality, because it becomes necessary unduly to press the reaction adjustment in order to obtain the necessary sensitivity. A set of this sort does not show up to best advantage when it is operated

at the limit of its range; but, used under reasonable conditions it is capable of giving entirely satisfactory service.

When an aerial-earth system is added, range is, of course, increased, and the set becomes comparable with any other det.-L.F. combination. Two aerial sockets are provided, a series condenser being inserted in one of the lead-in connections to improve selectivity, and also to offset the capacity of a large aerial.

Anode current consumption is quite moderate, amounting to some 9 milliamperes when grid bias is set at 6 volts. Where economy is vital the manufacturers recommend that bias should be increased to 7.5 volts; as is to be expected, there is some falling-off in quality when the output valve is operated in this way.

The set is made by the Eagle Engineering Co., Ltd., Warwick, and is sold at nine guineas complete.

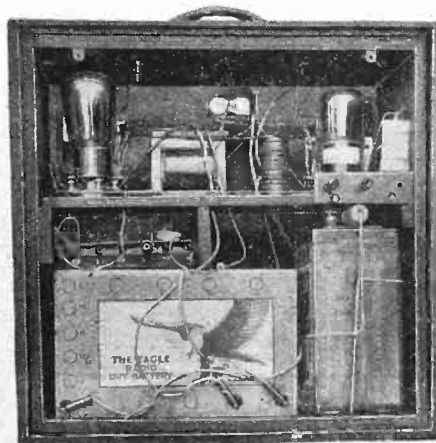

Rear view of receiver, with back cover removed.

CURRENT

TOPICS



IN BRIEF REVIEW

FORTHCOMING EXHIBITIONS.

An International Wireless and Gramophone Exhibition is to be held at Lyons from September 6th to 14th, and the Second Rumanian Radio Exhibition will be held at Bucharest from September 7th to 28th.

o o o o

LICENCES IN CANADA.

The number of receiving sets licensed for use in Canada on April 1, 1930, was 423,557.

o o o o

SHORT-WAVE TELEPHONY IN HAWAII.

The Federal Radio Commission of U.S.A. has issued licences to the Mutual Telephone Company of Hawaii for the use of ultra short waves (5 to 13 metres) for radio telephony. Five islands of the Hawaiian group are being linked up for inter-island telephone service, which will later be expanded to connect with the projected trans-Pacific radiotelephone.

o o o o

COUNTING BEES BY WIRELESS.

We hear that a system has been devised by the Entomological Office of the American Department of Commerce whereby the exit from the hive of each worker bee is recorded by means of a microphone, amplifier, and registering needle which duly imprints its mark on a sheet of paper. The bee-master is thereby enabled to estimate the number of active workers in each hive. Our correspondent does not inform us how the microphone distinguishes between exits and entrances—possibly a system of one-way traffic has to be used—but remarks that the number of stings will still be registered by the neighbours.

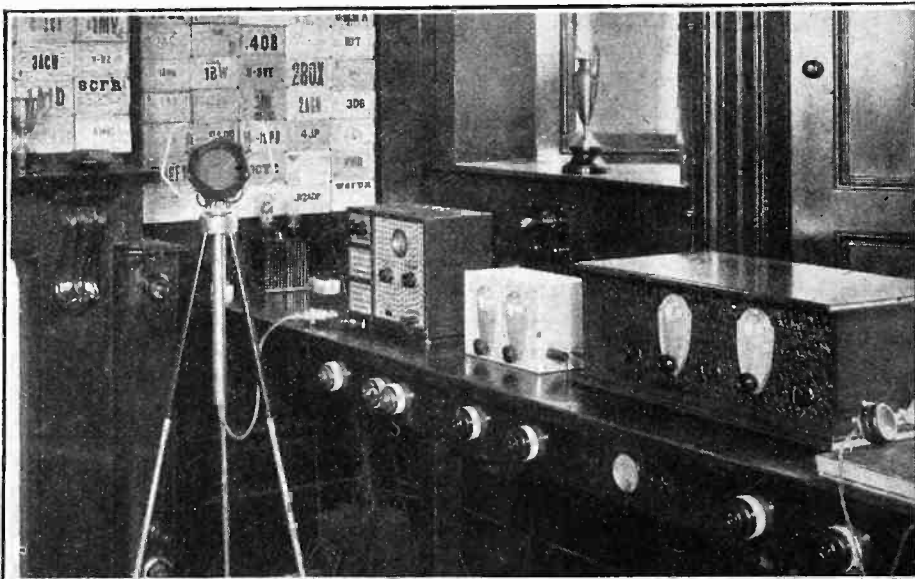

THE FIRST ENGLISH W.A.C. Mr. H. L. O'Heffernan, whose station G5BY at Croydon is illustrated above, was the first English amateur to gain the "Worked all Continents" Certificate of the International Amateur Radio Union. He also won the Silver Cup presented by our American contemporary "Q.S.T." for the best amateur station described in its pages in 1929. We are indebted to Messrs. Philips Lamps, Ltd., in whose Public Address department Mr. O'Heffernan is an Engineer, for the photograph of his station.

NEW STATION AT STRASBOURG.

It is expected that the new station which is being erected in Strasbourg will be ready for its tests next month, and that its formal opening will take place in October.

o o o o

HIGH-POWER STATION FOR CHINA.

The Chinese Government, having contracted with the Telefunken Company of Berlin for the erection at Nanking of one of the most powerful broadcasting stations in the world, is sending a group of Chinese engineers to Germany to inspect the stations of that country. The projected station at Nanking is expected to serve the whole area of the Chinese Republic.

o o o o

EMPIRE BROADCASTING.

Overseas listeners, for some time past, have been asking the B.B.C. to supply particulars of the main items of their forthcoming programmes well in advance of their respective dates to allow of publication in the local papers of distant countries, and it is understood that the first of these advance programmes has now been issued and despatched to the Far East.

o o o o

LONG-DISTANCE CONVERSATION WITH AEROPLANE.

Telephonic communication between an aeroplane flying above Buenos Aires and the White Star liner *Majestic* while nearing the English coast was successfully accomplished over a distance of about 8,000 miles. From Buenos Aires wireless connection was made with Madrid, thence by land-line to France, and by cable to Rugby, where wireless was again employed for establishing communication with s.s. *Majestic*.

o o o o

RUM-RUNNERS' SOS.

Wireless plays a conspicuous part on both sides of the game of rum-running as practised in the United States. On the one hand, we hear of secret transmitters discovered by the Federal Prohibition agents and, on the other side, of a sham SOS stating that the yacht in which the Mayor of New York was sailing was in peril. All the coastguard patrol rushed to the rescue, leaving the coast clear for the bootleggers' agents.

o o o o

INTERNATIONAL L CONFERENCES.

International Radio Conferences will be held in Copenhagen in 1930 and in Madrid in the following year. The first will be unofficial, but the Madrid Conference will be a meeting of all the leading nations of the world to revise and bring up to date the Radiotelegraphic Convention signed at Washington in 1927.

It is understood that, although Russia has not yet signified her intention of signing as an adherent of the International Radiotelegraphic Convention, she will be represented at both Copenhagen and Madrid.

WIRELESS THEORY

SIMPLIFIED

The THREE-ELECTRODE VALVE

(Continued from page 91 of previous issue.)

By
S. O. PEARSON
B.Sc., A.M.I.E.E.

IN order to understand clearly the meaning of the anode voltage/anode current characteristic of a valve, and to make practical use of it, it is necessary to know how the valve operates under normal conditions. This in turn necessitates a knowledge of the manner in which the potential of the grid relative to the cathode or to the negative end of the filament (according to the kind of valve) controls the anode current.

It has already been explained that the electric charge given to the grid modifies the field due to the space charge, and in this way controls the stream of electrons passing from the cathode to the anode. Suppose, for instance, that in a certain three-electrode valve the anode voltage and grid voltage are given suitable values and that the anode current is then noted. If now the potential of the grid is made slightly more positive the negative space charge will be neutralised to a slightly greater extent and more current will be allowed to flow in the anode circuit. When the grid is given a greater *negative* potential it assists the space charge in repelling electrons back to the filament and so reduces the value of the anode current.

The action of the grid is best exhibited by a curve showing how the anode current depends on the grid voltage, the anode voltage being maintained constant at some definite value during the time of measurement. It is further assumed that the cathode or filament is maintained at the normal operating temperature.

The circuit required to enable the measurements to be made is given in Fig. 1, which is the same as that of Fig. 2 in the previous part. To obtain a grid

for various values of grid voltage V_g adjusted by means of the slider on the potentiometer P. The voltages V_a and V_f must be kept constant during the time of taking one set of readings, but further sets of readings can be obtained with other fixed values of anode voltage V_a . There is a separate grid voltage/anode current characteristic curve for each value of the anode voltage, so that an unlimited number of such characteristic curves

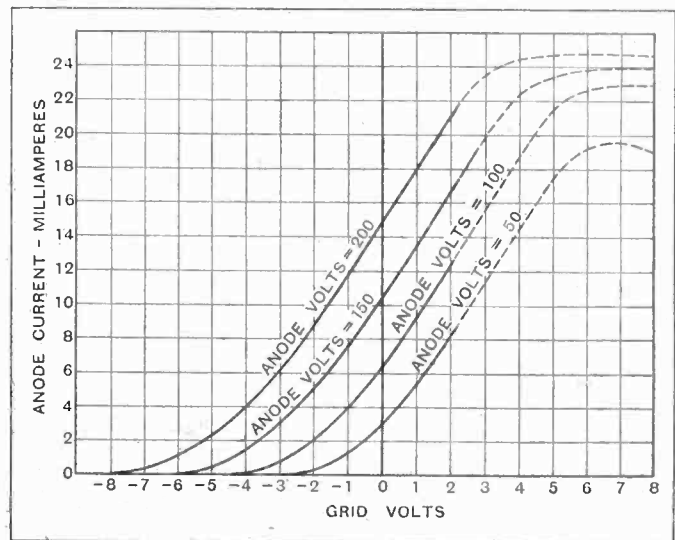

Fig. 2.—Grid voltage/anode current curves for a three-electrode amplifying valve.

can be obtained. When the valve is in use we can pick out the one which corresponds to the particular anode voltage employed.

The grid voltage/anode current characteristics of an amplifying valve with indirectly heated cathode are given in Fig. 2 for four separate fixed anode voltages as indicated on the curves themselves. The valve chosen as a representative example is one designed for an anode voltage not exceeding 200 volts. From any one of these curves it will be seen that as the grid voltage is varied from a highly negative value towards zero, that is, as the grid potential is made more positive, the anode current which is zero to begin with starts at some particular value of the grid voltage and increases, gradually at first, and then more rapidly until the curve reaches a maximum steepness. The point on the horizontal axis at which each curve begins depends on the value of the fixed anode voltage, but each curve has approximately the same slope at its steepest part. It will be realised at a later stage that this point is of considerable importance.

When the grid voltage is increased above zero in the positive direction each curve continues upwards

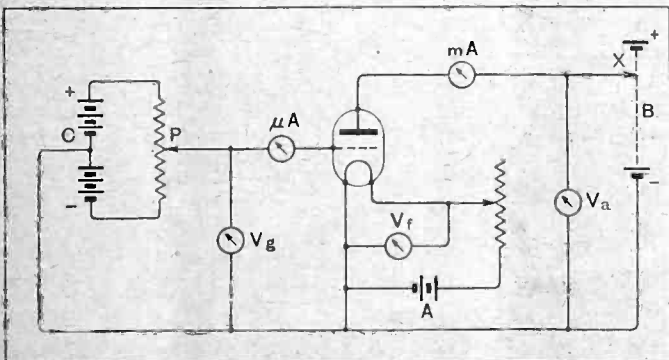

Fig. 1.—Circuit for experimental determination of the characteristic curves of a three-electrode valve.

voltage/anode current characteristic for the valve the anode voltage V_a is adjusted to an arbitrary value within the operating range specified by the makers, and the filament voltage V_f is set to the correct value. Then readings of the anode milliammeter mA. are taken

Wireless Theory Simplified.—

until the saturation current of the cathode is reached corresponding to the temperature at which it is being operated, so that all the curves bend over again and tend to become more or less horizontal at the top. From this it is obvious that each curve is very nearly straight at and near the point of greatest slope.

Grid Current.

So long as the grid is negative with respect to the cathode it has no attraction whatever for the free electrons moving through the vacuum. The latter are therefore allowed to pass on to the plate without any of them being trapped or intercepted by the grid. This means that for all negative potentials no current whatever will flow in the grid circuit and the microammeter μA will not indicate any current. On the other hand, when the grid is made positive relative to the cathode it will exert an attractive force on the free electrons and a certain percentage will be attracted to and intercepted by the grid. But owing to the high velocity of the electrons which have left the filament the great majority are shot through the meshes in the grid and successfully reach their normal destination on the anode. This is provided that the positive potential of the grid is not sufficiently high to overpower the action of the anode. With comparatively high positive grid potentials and low anode voltages the grid may intercept a large proportion of the electrons, with the result that the anode current begins to fall again as the positive voltage of the grid is still further increased. This effect is clearly shown by the 50-volt curve of Fig. 2.

Nevertheless, those electrons which are intercepted by the grid are led away to the cathode again via the external grid circuit through the microammeter μA , which therefore gives a reading. Now, it will be realised subsequently that a valve does not function efficiently as an amplifier when grid current is flowing, and therefore, for amplifying purposes, the valve is always operated with the mean grid potential negative. Thus as regards the grid voltage/anode current characteristic curves of Fig. 2 we are chiefly concerned with the portions which come to the left, or negative, side of the zero.

Amplifying Properties of a Valve.

The normal function of a three-electrode valve in a receiving circuit is that of an amplifier or intensifier of the electrical variations representing the received speech or music. It may be employed to amplify the modulated high-frequency oscillations before they are rectified, or it may be used to amplify the audio-frequency variations after they have been separated out from the H.F. oscillations by the agency of the rectifier. The

suitability of a valve for H.F. or L.F. amplification is determined by its general characteristics.

The amplifying property of a valve arises because a small change of grid potential produces a comparatively large change of voltage across a high impedance connected in series with the anode circuit. The degree of amplification obtained is determined not only by the constants of the valve itself, but also by the nature of the "load" connected in the anode circuit. One

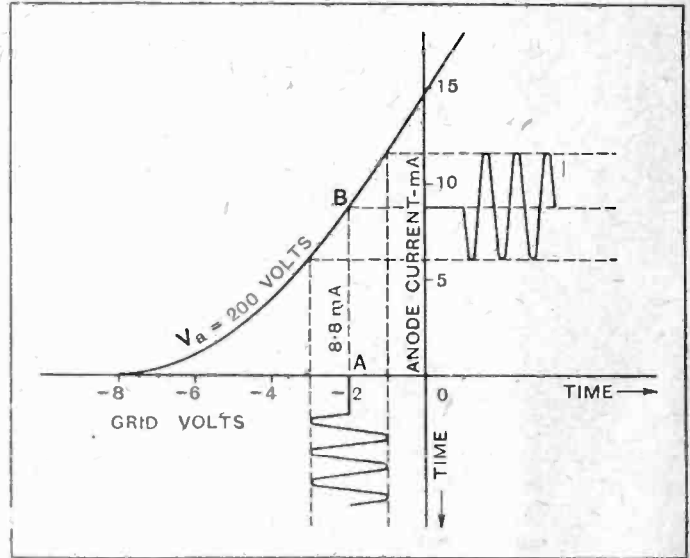

Fig. 4.—Diagram showing that a small periodic variation of the grid voltage of a three-electrode valve causes a corresponding variation in anode current. When operation occurs over a straight part of the anode characteristic the variations of anode current follow exactly those of the grid voltage.

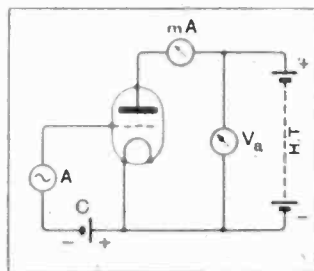

Fig. 3.—In the arrangement shown the voltage applied to the grid is made to vary periodically about the mean value determined by the "grid bias" battery C. A is a source of alternating E.M.F. The effect on the anode current is explained in the text.

of the most important details in the designing of an amplifier is the predetermination of the actual amplification that will be obtained with the particular valves and components used. To do this we must be able to express the characteristics of the valve itself in terms of constants derived from the static characteristic curves. The derivation and explanation of these constants will therefore be obtained with the aid of characteristic curves of an actual valve.

In the first place, then, let us see what happens when the voltage applied to the grid of a valve is made to vary periodically by a small amount above and below the mean value, the anode potential being maintained constant at a suitable figure. For instance, suppose that the valve is connected up as in Fig. 3, where C is a battery determining the mean potential of the grid relative to the filament, and A is the source of alternating voltage causing the potential of the grid to increase and decrease periodically about the mean value of bias potential.

To make the explanation consistent we shall assume that we are dealing with the same valve to which the anode characteristic curves of Fig. 2 refer and that the anode potential is maintained at 200 volts. The grid voltage/anode current characteristic curve corresponding to this value of anode voltage has been redrawn separately, and is shown in Fig. 4, there being no external resistance or impedance in the anode circuit of the valve.

Wireless Theory Simplified.—

Now, if the mean grid potential is set to such a value OA that the corresponding point B on the anode current curve occurs on the moderately straight portion as shown, any *small* change in grid voltage will cause a proportional change in anode current. No matter whether the negative grid voltage be increased or decreased by that given small amount; the change in anode current will be the same; but when the negative voltage on the grid is increased the anode current will be decreased, and *vice versa*.

Consider now what occurs when the grid voltage is made to vary periodically above and below the mean value OA by one volt. For convenience and simplicity we shall assume that variation obeys a sine law. Referring again to Fig. 4, the relationship between grid potential and time can be seen. The mean grid potential is -2 volts, and the maximum variation is one volt above and below this, so that actually the grid voltage is "swinging" between -3 and -1 volt. Under these conditions the "grid swing" is said to be 2 volts.

Since, under the conditions chosen, the change of anode current is at every instant proportional to the change of grid voltage from the mean value, the anode current will also vary above and below a mean value (in this case 8.8 milliamps) according to a simple sine law. The graph showing the variation of anode current with time can be deduced from the other two in the manner indicated in Fig. 4. This latter graph is shown in the upper right-hand section, from which the anode current is seen to vary between 6 mA. and 11.6 mA., the mean value being 8.8 milliamps.

Mutual Conductance.

Although under operating conditions in a receiver a valve is never used without a resistance or impedance of some sort connected in the external anode circuit, a considerable amount of information can be gleaned from Fig. 4. First and foremost, it gives us the numerical relationship between change of grid voltage and change of anode current at constant anode potential when the valve is operated on the straight portion of its anode characteristic. The ratio of the change of anode current to the change of grid voltage producing it is called the "*mutual conductance*" of the valve.

In this case a change of 5.6 milliamps in the anode current is produced by a change of 2 volts in grid potential. The mutual conductance is therefore 2.8 milliamps per volt. This is really the numerical value of the slope of the anode characteristic curve at the operating point. It will be seen later that the mutual conductance expressed in amps per volt is also numerically equal to the ratio of the amplification factor to the A.C. resistance of the valve.

The Amplification Factor.

It has been shown so far that for a three-electrode valve there are two ways of varying the anode current, namely, by changing either the grid potential or the anode voltage. Two anode voltage/anode current curves for the valve we have been considering are given in Fig. 5 for grid potentials of zero and -2 respectively. Now, from Fig. 4 we find that for 1 volt change in grid potential the change of anode current is 2.8 milliamps (the mutual conductance) with the anode at 200 volts, but from the lower curve of Fig. 5, the one corresponding to the mean grid potential in use, we find that it requires a change of about 36 volts in

the anode potential to produce the same change of 2.8 milliamps. Thus changing the grid potential by one volt has the same effect as changing the anode potential by 36 volts. This means that a given change of grid potential is equivalent to a much larger change of anode voltage in its effects of the anode current, and the amplifying properties of a valve arise out of this fact.

The "amplification factor," or "amplification constant," of the valve is the ratio of the change of anode voltage required to bring about a given small change of anode current

to the change of grid voltage necessary to produce the same change of current. For our valve, then, the amplification factor is 36. The amplification factor is usually denoted by the Greek letter μ (mu); it is the greatest possible value of voltage amplification which the valve is theoretically capable of giving (except when a step-up transformer is used). In practice the actual direct amplification obtained is always less than μ , but can be calculated in terms of μ and the constants of the associated circuits.

(To be continued.)

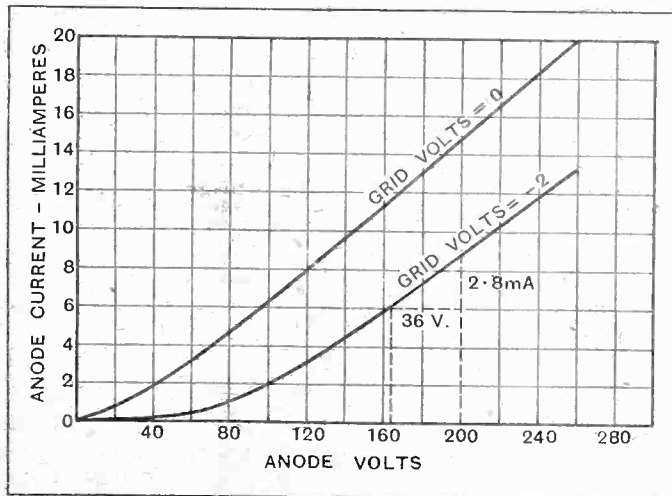

Fig. 5.—Anode voltage/anode current curves for the same valve to which Figs. 2 and 4 refer. When the grid voltage is -2 a change of 36 volts in the anode potential on the straight part of the curve changes the anode current by 2.8 mA., the change caused by one volt variation on the grid. The amplification factor is therefore 36.

The AUGUST issue of "EXPERIMENTAL WIRELESS AND THE WIRELESS ENGINEER" will contain, amongst other features, the following articles—

Flat Piston Moving Coil Loud Speakers. By Robt. W. Paul, M.I.E.E., F.Inst.P., and B. S. Cohen, M.I.E.E.
On Banks of Paralleled Valves Feeding Reactive Loads without Distorting the Wave-form. By W. Baggally.

Sidebands and Selectivity. By Prof. G.W. O. Howe, D.Sc., M.I.E.E.
Units Used in Telephone Transmission Engineering. By W. H. Grinstead, A.M.I.E.E., A.C.G.I.
Electrical Wave Filters. By M. Reed, M.Sc., A.C.G.I., D.I.C.

The B.B.C. Referendum.

Although the B.B.C. has hinted at the possibility of a referendum, first, to ascertain from all concerned whether the adult lectures and talks are really popular, and, secondly, to find out listeners' opinions on the timing and make-up of the programmes generally, I understand that the question how such a referendum may best be conducted is proving somewhat baffling.

o o o o

Who Should Organise the Enquiry?

Who are the statistical experts that may be called in to co-operate? Should the Central Council for Broadcast Adult Education have any part? Should even the B.B.C. itself take any part in such a referendum? It would smack rather of an *ex parte* arrangement, and there is a feeling that the organisers should be entirely free and independent.

o o o o

Would It Be Really Representative?

Again, unless it were possible to make any referendum compulsory and universal—at all events on the general programme—it would be worthless. Only extremists would probably reply, and there might conceivably be a preponderating number of votes in favour (say) of giving more time to the enjoyment of saxophones, muted trumpets and American sentimentality to the exclusion of classical music, but such voting would not represent the views of the vast majority of listeners who can appreciate both classical and light music, vaudeville and dance music, but who do not feel called upon to write to the B.B.C. on the matter.

o o o o

Striving for Perfection.

Those who heard the New York Philharmonic Symphony Orchestra before it returned to the United States must have been struck by the wonderful precision and unification displayed. The twenty or so first violins sounded like one 20 fiddle-power instrument played by one performer, and each individual group of instruments showed the same unanimity. This state of perfection can only be obtained by assiduous rehearsal, and it is the object of the new B.B.C. Symphony Orchestra to emulate or even surpass this good example.

o o o o

Expense of Rehearsals.

Rehearsals are an expensive item in orchestral work, but in this case they will be plentiful. A Symphony Concert may involve three rehearsals of three hours duration, oratorio or opera as many as four sessions each of three hours' strenuous work, while two light programmes in which the Symphony Orchestra is split up into two entirely separate bodies will probably each be given four hours' rehearsal. Most of the instrumentalists have already worked together for a long time; they are all engaged on full-time contracts, and no deputising, except in case of illness, will be permitted. We may expect, therefore, to find little lacking in the way of team work.



By Our Special Correspondent.

Talkies v. Orchestra.

The short note on "Talkies Oust Organ and Orchestra" which appeared in our issue of July 16th may have given the impression that the orchestra and organ of the Brixton Astoria would be entirely replaced by "Talkie" music. This is not the case, and I am informed that although the orchestra and organ will not be broadcast, they will still remain an integral part of the organisation of the Brixton Theatre.

o o o o

Another Tattoo.

The Tidworth Tattoo, one of the great military events of the year, will be broadcast in the National programme on August 5th.

FUTURE FEATURES.

National (261 and 1,554 metres).
AUGUST 3RD.—Old Contentibles' Service, relayed from St. Martin-in-the-Fields.

AUGUST 4TH.—"Suitable Songs," Part 4.

AUGUST 5TH.—Relay from Tidworth Tattoo.

AUGUST 6TH.—Orchestral concert from National Eisteddfod of Wales (from Cardiff).

AUGUST 7TH.—"The Wedding," a farce in one act, by Anton Chekov.

AUGUST 8TH.—Vaudeville programme.

AUGUST 9TH.—Opening concert of the Promenade Concerts, relayed from the Queen's Hall.

London Regional.

AUGUST 3RD.—Orchestral programme of works by British composers.

AUGUST 4TH.—Light orchestral programme.

AUGUST 5TH.—Chamber music concert.

AUGUST 6TH.—"The Wedding," a farce in one act, by Anton Chekov.

AUGUST 6TH.—"Great Grandfather's Songbook," a Selection of Popular Songs of 1770.

AUGUST 8TH.—"Impromptu" programme.

AUGUST 9TH.—Band concert, relayed from Brighton.

Midland Regional.

AUGUST 5TH.—The "Pro Rata" Concert Party, relayed from Jephson Gardens, Royal Leamington Spa.

AUGUST 9TH.—Military Band concert.

West Regional (Cardiff).

AUGUST 4TH.—Orchestral programme relayed from the National Museum of Wales.

AUGUST 6TH.—"The Pled Piper of Hamelin," a Cantata, by Sir Hubert Parry.

AUGUST 7TH.—Rt. Hon. David Lloyd George speaking at the Royal National Eisteddfod of Wales.

North Regional (Manchester).

AUGUST 6TH.—Band concert, relayed from West End Bandstand, Morecambe.

AUGUST 7TH.—Orchestral concert, relayed from Pavilion Gardens, Buxton.

Glasgow.

AUGUST 6TH.—Variety concert, relayed from Beach Pavilion, Aberdeen.

Belfast.

AUGUST 5TH.—"The Burglar who Failed," a Comedy in one act, by St. John Hankin.

Scottish Regional Station.

The Scottish Press has been actively engaged with settling, to its own satisfaction, the legal formalities involved in the B.B.C.'s purchase of a site for the Scottish Regional station, but I am able to confirm the statement made last week and say definitely that no site has yet been acquired nor is even on the point of being acquired.

The site at Falkirk is being more closely investigated than any others of those which are under consideration and, if it is found that the subsoil is suitable, that will probably be the site chosen, but if further examination reveals an admixture throughout of clay, sand and gravel or any two of these substances, it is probable that the engineers will resume their search in fresh pastures.

o o o o

Records of Historical Events.

I understand that an attempt is being made in the United States to preserve records of eventful broadcasts especially those of historical interest, but I doubt whether the scheme will prove successful. The making and preserving of suitable records is not an easy matter. Two hundred records obtained by two well-known mechanical devices used to be kept at Savoy Hill, but these were all scrapped as they were considered useless for any possible re-broadcast.

Gramophone records are, of course, used nowadays for sound effects, such as the noise of railway engines, the plaudits of a crowd, a soft orchestral background to a dialogue, or the twittering of birds. The broadcast of the nightingale, I am assured, was *not* done by this means.

o o o o

Possible Use in Rehearsals.

It seems a pity that it was found impracticable to keep suitable records of interesting events broadcast in times past if only for the sake of marking the technical progress made. Would it not be feasible and worth the expense to take a few records, at any rate of some of the leading artistes, at rehearsals so that they might hear how they "came over" and possibly correct any errors? I am told that one of the best-known of our character actors was thoroughly convinced, when he first broadcast, that his performance was a bad one. The damping effect of the studio and his own efforts to listen to himself were disconcerting, but as a matter of fact, he got over remarkably well.

o o o o

Dramatic Broadcasting: A Comparison.

The National Broadcasting Company of America has published an interesting comparison between the methods used in U.S.A. and in England. The B.B.C. as a rule uses several studios, one for the actors, another for sound effects, another for music, and so on, whereas the custom in America is to employ a single studio. Each system is considered most suitable for its particular purpose. In England radio-dramas are comparatively long and the multiple-studio is certainly preferable, but in America fifteen-minute sketches are the rule, and these are best done in a single studio.

N. & K. FARRAND INDUCTOR.

This loud speaker which is of the moving iron type employs a novel principle, and from a technical point of view is one of the most interesting recent developments in loud speaker design. The armature consists of two soft iron bars coupled by light but rigid rods, and mounted between pole pieces on two flexible phosphor bronze springs in such a way that the armature system as a whole moves in a plane parallel to the pole faces. The speech coils are wound round the laminated poles, and the variations produced in the permanent flux tend alternately to eject or attract the armatures between the air gaps.

Terminals are provided to match valves of high (3,000—6,000 ohms) and low (1,000—2,500 ohms) impedance. The measured impedances at octave intervals over the useful musical range were as follows:—

IMPEDANCE (OHMS).

Frequency.	Series.	Parallel.
50	1,900	408
100	772	219
200	1,650	529
400	3,510	1,280
800	6,400	1,730
1,600	11,200	3,090
3,200	20,200	5,380
6,400	—	9,000

The performance is remarkable for the unusual output in the bass. The ampli-

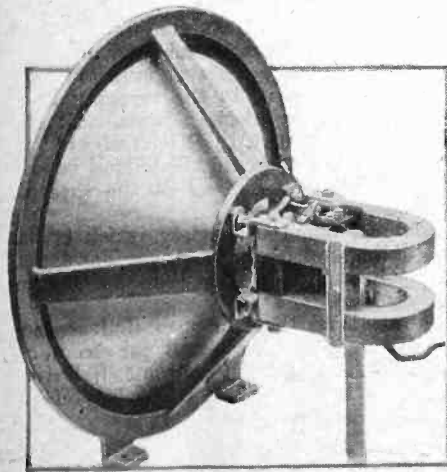

Farrand inductor loud speaker chassis.

tudes developed at 50 and 100 cycles are even greater than those produced by the average moving coil, and are easily visible at 50 cycles. From 150 cycles upwards the output is on a lower relative level and is free from peaks, but two "valleys" occur, one at about 3,000 cycles and another of quite appreciable depth at 2,000 cycles. The acoustic output at 5,500 cycles is equal to the general level in the middle register, but there is a falling off at 6,000 cycles.

To sum up the performance, we may say that the general effect is perhaps the

LABORATORY TESTS on New Apparatus.

A Review of Manufacturers' Recent Products.

closest approximation to that of the moving coil that has yet been achieved with a moving iron armature, the reason, of course, being the enhanced output below 150 cycles.

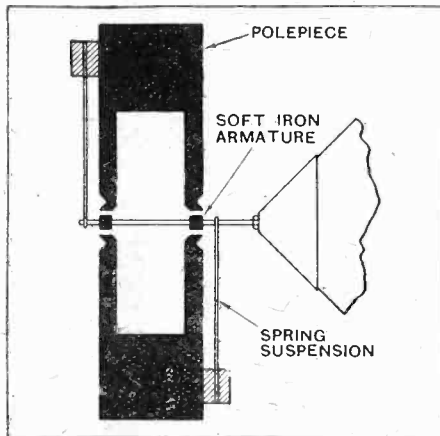

Arrangement of armatures and pole pieces in the Farrand inductor loud speaker.

Supplies are obtainable in this country from A. Brodersen, 228, Goswell Road, London, E.C.1, and the price of the chassis only is £3 12s. 6d.; in cabinet form the price is £6.

COILS FOR FOREIGN LISTENER'S FOUR.

In the recent design of the battery and D.C. operated Foreign Listener's Four, coils were used with self-contained wave change switching. The switches were operated by an 1/4 in. brass rod running through bakelite bars, bearing points being obtained for this operating rod in

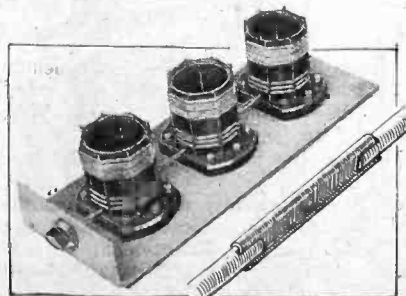

Colvern coils for the D.C. Foreign Listener's Four, enlarged view of link shown in the sketch.

the sides of the coils. While this form of construction involved but little difficulty it necessitated the procuring of a straight piece of 1/4 in. brass rod and the fitting up of a suitable operating key.

Colvern, Ltd., Mawneys Road, Romford, Essex, have now simplified the setting up of the coils by providing each coil with a brass spindle and arranging for ganging by means of slotted ends and link pieces. A switch-fitted coil is therefore supplied complete with brass spindle, one connecting link, operating key and locking ring. This form of ganged switch operation will be found particularly useful in the construction of sets where a number of tuned circuits are employed, such as in receivers embodying H.F. or band-pass arrangements. A merit of the system is that a flexibility is obtained in the connecting links which removes the need for precise alignment when positioning the coils.

o o o o

CELESTION "TILTATONE."

This unit is a combined volume control and tone corrector for use with electrical reproducing gramophones. It is connected between the pick-up and the amplifier, and special attention has been given to the question of screening and earthing. The G.B. terminal to the amplifier is connected internally to one of the pick-up terminals, so that if there is an earth connection in the amplifier there is no need specially to earth one side of the pick-up to prevent instability.

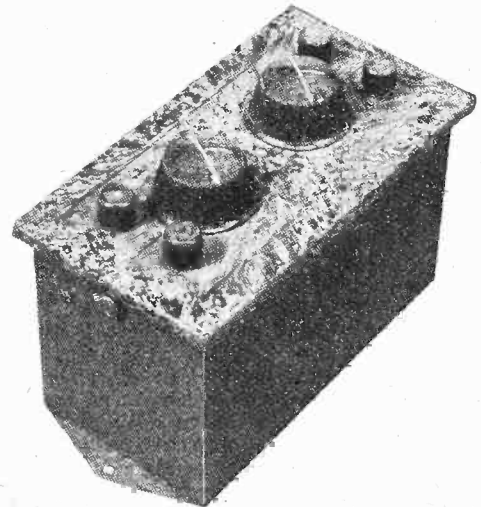

Celestion "Tiltatone" which combines in a single unit a volume control and tone corrector for electrical pick-ups.

There are two independent controls on the unit, one for volume and the other for tone. It is generally conceded that the most common fault to be found in the reproduction of the average amplifier loud speaker combination at the present time is over-accentuation of the middle register, or, put in another way, high- and low-note loss. The "Tiltatone" has therefore been designed to give a continuously variable control over the volume in the middle register without appreciably affecting either the very high or very low frequencies.

On test, the tone control worked exactly according to plan, and the range of control provided should be sufficient to cope with the most flagrant cases of resonance in the middle register. A slight diminution of very high frequencies was detectable when the tone control was adjusted to give maximum suppression of the middle register, but the low-note reproduction was

absolutely unaffected. The general volume control gave even distribution of the volume over the range of movement of the knob, and no reduction of high frequencies in relation to other frequencies could be detected even at the minimum audible setting.

The unit gives an overall step-up of voltage, so that less amplification is needed

(than when the pick-up is connected to the amplifier direct. Incidentally, the same system of tone correction has been in use in Celestion public-address systems for about three years.

The price is £4 17s. 6d., and the makers are Celestion, Ltd., London Road, Kingston-on-Thames; and 106, Victoria Street, London, S.W.1.

CORRESPONDENCE.

The Editor does not hold himself responsible for the opinions of his correspondents.

Correspondence should be addressed to the Editor, "The Wireless World," Dorset House, Tudor Street, E.C.4, and must be accompanied by the writer's name and address.

BROADCAST PROPAGANDA.

Sir,—Although all the well-known hair restorers in the British Isles have so far failed to tune in a single new hair on my head, I still believe in the amazing power of advertising. Without it the Press of this country would practically cease to exist. The *Daily Mail* would probably shrink to the size of a lady's handkerchief and the dear old *Wireless World* to the size of four postage stamps.

Therefore, I am particularly surprised when you, as Editor, declare in your issue of June 18th that it would be a retrograde step to use the ether (by kind permission of the P.M.G.) for advertising purposes.

Competent listeners have calculated, I believe, that broadcasting is 99.8 per cent. mediocre, trivial and childish as a source of amusement. Indeed, it is exceptional for any normal person to anticipate an evening's radio enjoyment in the same way as he does when booking a seat at a theatre, or running for a bus to the nearest picture palace. We go to a show because we want to: but we listen-in—usually—because we've nothing else to do at the moment. This is bad for the reputation of the B.B.C., and very bad for us.

I suggest that it is now time that something should be done to save us from further demoralisation. The B.B.C. is particularly in need of stimulating competition and of more funds for better artists. To obtain more money from the P.M.G. would be half as difficult again as extracting red corpuscles from a piece of flint; and to charge more for the licence would be pointless if we—the listeners—can get what we want from other sources.

We can solve much of the money question and still more of the quality question immediately if only we will accept Sponsored Programmes—that is, programmes sponsored by firms or individuals who are willing to spend fabulous sums if we will but listen for a moment or two to their tale of wares.

Good, solid, bewhiskered, ancient Britons approach their sets with clubs in their hands and the spirit of destruction in their hearts at the mere thought of radio advertisements. They hear of the terrible state to which it has brought American broadcasting—and they will have none of it. They picture purveyors of pills introducing patent medicines into Chamber Music, or perverting plays by unseemly references to cures for asthma. They shudder at the thought of a foxtrot entitled "Nippy," or of a vaudeville turn by Freeman, Hardy and Willis. Although Guinness may be good for you on posters, it might be positively dangerous when served up through the ether.

The truth is, of course, that our prohibition of radio advertising is just as narrow-minded as the American prohibition of alcoholic enjoyment. The Americans see what drink has done to us, and we see what advertising has done to American broadcasting. In our distinctive ways we are both excellent examples of pious frauds. Having observed what Sharkey did to Scott, we should now be logical and say: "This is what boxing has descended to. Therefore, let us prohibit it."

The sanest way is to dally with beer and boxing, subject to certain restrictions, and to adopt the same attitude towards sponsored radio programmes.

With the London, Midland and National Stations in full working order, the B.B.C. have at last plenty of spare room in the ether for outside help (or competition). Why should they not sell for good money some of this surplus space in space? Why

should not an ethereal hoarding or two be dotted across the heavenly highways? It would swell the B.B.C. funds and—still more important—add to listeners' entertainment and amusement. No advertiser would dare to put on the ether the soporific items with which the B.B.C. pad their time-tables.

To quote instances of the disfigurement of scenery with advertisement hoardings is no analogy. This does neither the motorist nor the countryside any good. If, in return, the advertisers improved the roads, tidied up the litter left by trippers, planted trees and flowers (for motorists to pick), and made the landscape better generally, then who would object to a few picturesque posters planted here and there amidst a re-beautified countryside? This is a true analogy.

A limit could be placed on the time during which a sponsor might make a few casual remarks concerning the desirability of purchasing his wares, or the danger of neglecting to partake of his pills. The method of displaying his goods could also be under supervision. We could trust the B.B.C. to do that quite efficiently!

There is no reason, too, why the sponsor should not embody in the programme a song, a short play, or a turn wherein tactful and tasteful reference could be made to the subject nearest his heart and pocket.

A play might open: "Good morning! Have you used . . . ?" And end: "Good night! And don't forget, dear, your nightcap of Vitaline. Two teaspoonfuls in half a glass of milk and you will sleep like a top, awaking refreshed in the morning . . . Good night everybody. Midland now closing down. All the staff here are trying this new nightcap . . . GOOD night!"

After three hours of real amusement, would this offend us any more than the advertisement-clad drop-curtain at the theatre, and the winking sky-signs on the way home?

Either Sponsored Programmes and that variety which is the spice of life—or the same dull round of dance music, dowagers, and drawing-room "entertainers" as dispensed by Doctor B.B.C.

Take your choice! But remember that the spoon-fed are not always the healthiest. What is an occasional jar from an advertisement compared with the present chronic irritation caused by mediocre programmes?

BERTRAM MUNN.
Twickenham.

REPETITION OF PROGRAMME ITEMS.

Sir,—In July 16th issue of *The Wireless World*, under the heading "Broadcast Brevities," your special correspondent makes the following remarkable statement: "It is not often, however, that an item from one station creates so much interest as to be repeated by another at a later date." I submit that many items from one of the Brookmans Park transmitters create so much (official or vested) interest as to be repeated by the other transmitter at a later date, often the following day. Indeed, one instance of this practice is foretold by your special correspondent on the very page containing the above-mentioned statement. Can such programme arrangements legitimately be called "alternative"? Personally, I think not, and am surprised never yet to have read a protest on the subject in your columns.

I enclose my card, but beg to sign myself

N. GINEA.

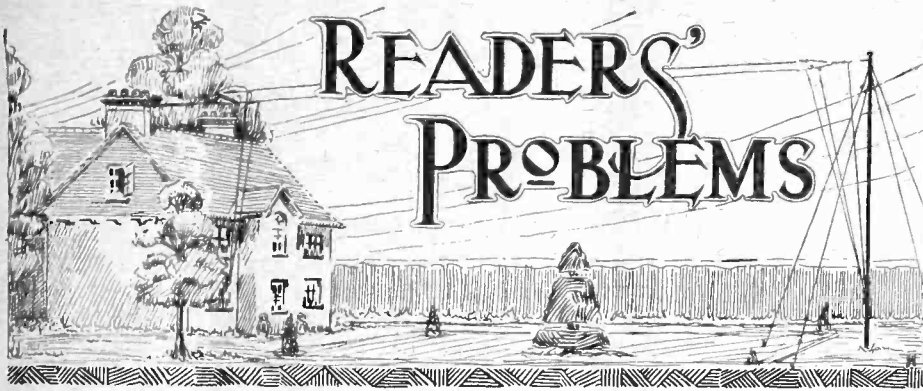

"The Wireless World" Supplies a Free Service of Technical Information.

The Service is subject to the rules of the Department, which are printed below; these must be strictly enforced, in the interest of readers themselves. A selection of queries of general interest is dealt with below, in some cases at greater length than would be possible in a letter.

Relative Efficiency.

Will you tell me if an indoor aerial with a maximum height of nearly 30ft., and with a horizontal length of 25ft., is likely to be more efficient than a frame aerial with sides of about 2ft? It is quite impossible for me to put up an outside aerial, and I wish to obtain the maximum possible sensitivity from my receiver.

J. W. M.

Unless the inside aerial happens to be very badly screened by metal work in close proximity to it, there can be no doubt that it will be more efficient as a collector than a frame aerial of the dimensions given.

Coil Terminals.

When reference is made to the "lower end" of a coil, should it be understood that the expression refers to the low-potential end of the inductance in an electrical sense, and not to its physical position?

O. M. N.

Unless the context makes it quite clear that reference is being made to the physical positions of the extremities of the coil, it is quite safe to assume that

RULES.

- (1.) A query must be accompanied by a COUPON removed from the advertisement pages of the CURRENT ISSUE.
- (2.) Only one question (which must deal with a single specific point) can be answered. Letters must be concisely worded and headed "Information Department."
- (3.) Queries must be written on one side of the paper and diagrams drawn on a separate sheet. A self-addressed stamped envelope must be enclosed for postal reply.
- (4.) Designs or circuit diagrams for complete receivers or eliminators cannot ordinarily be given; under present-day conditions justice cannot be done to questions of this kind in the course of a letter.
- (5.) Practical wiring plans cannot be supplied or considered.
- (6.) Designs for components such as L.F. chokes, power transformers, complex coil assemblies, etc., cannot be supplied.
- (7.) Queries arising from the construction or operation of receivers must be confined to constructional sets described in "The Wireless World": to standard manufactured receivers; or to "Kit" sets that have been reviewed.

a statement of this sort relates to the A.C. voltage distribution along the winding. Colloquially, the end of an inductance that is connected either to filament or to the source of H.T. voltage supply is generally called the lower end.

Fieldless Chokes.

I have noticed that many of your contributors of published designs for receivers seem to prefer the use of binocular H.F. chokes in the anode circuit of the detector valve. Is this a matter of great importance? Unless there is any objection, I propose to use an ordinary section-wound choke (of a good make which has been favourably reviewed in your columns) in the construction of my new 2-v-1 receiver.

P. N. M.

A choke with a restricted external field is very often used in a 2 H.F. receiver (particularly when a high-magnification H.F. amplifier is employed) because it might otherwise be difficult to prevent stray coupling between the choke which is in the detector anode circuit and other inductive windings.

If you take care to see that all possibility of these stray couplings is avoided, there is no reason why your existing choke should not be used.

H.F. Stopping Resistances.

In receivers designed for the normal broadcast wavebands, H.F. stopping resistances of from 0.1 to 0.25 megohm are often inserted in series with the grids of the L.F. amplifying valves. Would it not be correct to use a considerably lower value of resistance when building a short-wave receiver?

G. C. E.

These H.F. stoppers operate by virtue of the ratio between their resistance and the reactance of incidental grid-filament capacities in the valve: as the reactance of these stray capacities is very much less when ultra-short wavelengths are being dealt with than in a receiver designed for normal frequencies, it follows that the usual values could, as you suggest, be reduced appreciably. However, a series

grid resistance of, say, 0.1 megohm is not likely to cause any appreciable high note loss, and we think it would serve no useful purpose to reduce its value much below that figure.

o o o o

Volume Control Affects Tone.

The volume control which is connected to my pick-up is effective in so far as it enables me to reduce intensity to any desired level, but when its knob is set in the "weak" position there is a distinct lowering of tone and reproduction is lacking in brilliancy. Do you think that matters could be improved by using some other form of control, and, if so, will you suggest the best method?

H. R.

It seems certain that your volume control is in the form of a variable resistance in shunt with the pick-up windings; for reasons that have been discussed at length in the pages of this journal, it is a fact that this method may introduce serious attenuation of the upper frequencies.

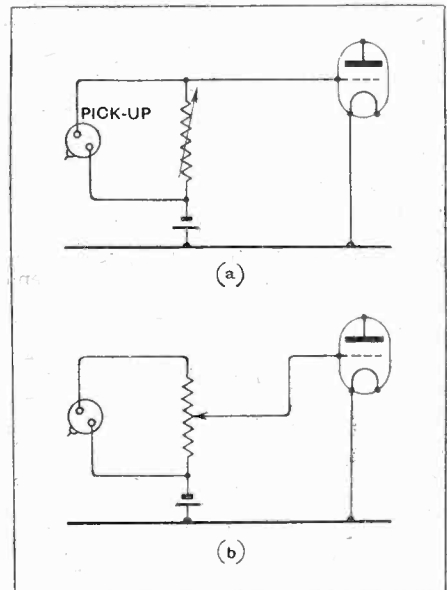

Fig. 1.—Volume control for a pick-up. High note loss introduced by a shunt resistance (a) may be avoided by substituting a potentiometer (b).

In Fig. 1 (a) we show what is probably your present scheme of connections; in Fig. 1 (b) is given an improved method which makes use of a potentiometer which should have a resistance of at least 100,000 ohms.

o o o o

Reducing Screening.

I am about to build a receiver on the lines of the "Band Pass Four," but, as it is, if possible, to be mounted in an existing cabinet, I should like to reduce its overall dimensions slightly. Do you consider that it would be permissible to use rather less comprehensive screening than in the original model as described?

N. N. E.

We would dissuade you from attempting to make any radical alteration in this respect, although it might be possible to avoid the use of a screening box for the first tuned input circuit components.

High Note Loss.

Although my new receiver is working quite well, I am not altogether satisfied with the quality of reproduction. The trouble seems to be most marked on speech—perhaps because I have not a good musical ear. "S" sounds do not seem to be properly reproduced, with the result that speech is sometimes difficult to follow.

Can you give me any idea as to what is likely to be wrong?

M. C. M.

It is very probable that "high note loss" is taking place in your receiver; this is almost always indicated by poor reproduction of sibilants. The trouble may be traced to the H.F. amplifier and tuning circuits, where it can be caused by undue sharpness of tuning. Equally, the L.F. side of the set may be at fault, and effects of this sort are generally attributed to the use of excessively high anode resistances, of unduly large by-pass condensers, or even to the presence of excessive stray capacities in anode circuits.

There remains the possibility that, due to interstage reaction, the L.F. amplifier is giving excessive proportional amplification of a fairly low frequency.

If you care to send us a circuit diagram of your set, with values marked on it, we will endeavour to make a definite suggestion, but before going further, we would advise you, if possible, to make a test with another loud speaker.

A Composite H.F. Amplifier.

I am thinking of making up a two-stage H.F. amplifier with an S.G. valve and a neutralised triode, using for the latter the coupling transformers which have already stood me in good stead in a set with a single H.F. stage. In what order would you advise me to use the two valves?

R. P.

This is a nice point and, except from considerations of selectivity, there should be little difference whichever way the stages are arranged, at any rate if you intend to use double-wound transformers for both of them.

We think that the selectivity of the set will be rather better if the aerial input is fed to the neutralised triode, and so we recommend you to adopt this scheme.

o o o o

Pick-up Connections for the Band Pass Four.

If it is possible to do so, will you please show me how to connect a gramophone pick-up to the Band Pass Four receiver?

If possible, I should like to retain the feature of free grid bias, and will, of course, make provision for switching off the H.F. valves when the set is being used for gramophone reproduction.

P. B.

This set works quite well as a radio gramophone, provided that a fairly sensitive pick-up is used. In addition to providing a switch for interrupting current supply to the H.F. valve heaters, it will be necessary to insert a single-pole double-

throw switch in the detector grid circuit, arranging its connections in the manner shown in Fig. 2. When the H.F. valves are switched off the flow of current through the original bias resistance R_{12} will be reduced, bringing about a consequent reduction in bias; accordingly it will be necessary to provide an extra bias

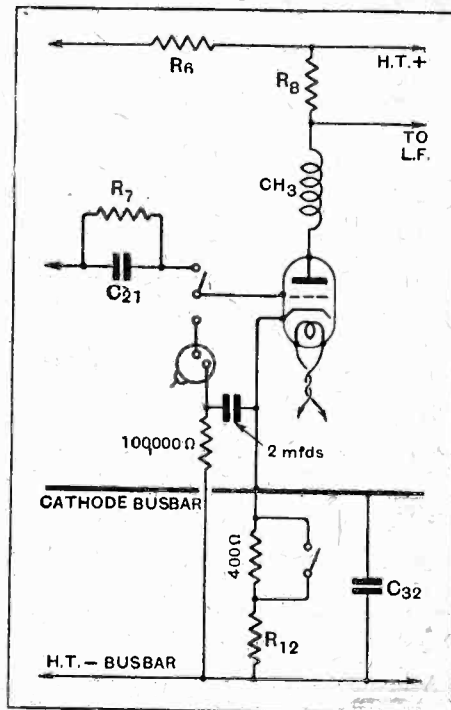

Fig. 2.—Detector grid circuit of the "Band Pass Four," modified for insertion of a gramophone pick-up.

resistance as shown. This resistance must be shunted by a switch in order that it may be short-circuited when the set is used for its normal purpose of receiving radio signals.

To avoid complexity in drawing, separate switches are shown, but there is no reason why they should not be combined in a single instrument.

o o o o

Insufficient Range.

Do you think that the "Power Pentode Two" ("The Wireless World," May 7th) would be sensitive enough for use in this locality?

From my experience with other det.-L.F. receivers, I have no doubt that it would be possible to obtain quite loud signals, but I am uncertain whether it would be possible adequately to load the power-grid detector valve.

N. C. L.

We see that you live at a distance of about seventy miles from the nearest station, and in these circumstances we do not consider that the "Power Pentode Two" is sufficiently sensitive to provide consistent reception combined with the high quality of which a receiver of this kind is capable.

As you suggest, there should be no difficulty with a large aerial in getting signals of a sort, but it is certain that, to "fill up" the detector—even if it were possible to do so, which we doubt—

it would be necessary to make excessive use of reaction. A stage of H.F. amplification seems to be clearly indicated.

o o o o

Total Anode Current.

Will you please tell me how to connect a milliammeter (which is normally used to indicate output valve overloading) in such a way that it will show the total anode current consumed by all the valves in my receiver?

E. T. W.

This is quite simple: all you have to do is to connect the milliammeter between the H.T. negative terminal of the set and the negative terminal of the H.T. battery or eliminator.

We should add the warning that unless the various anode circuits are properly decoupled it is just possible that the insertion of the meter (which will have an appreciable resistance) may provoke self-oscillation, as this resistance is common to all anode circuits. The trouble will not arise if a proper system of decoupling is employed.

It will hardly be necessary to say that a measuring instrument inserted in this position will also show the screening grid current of any S.G. valves that may be included in your set.

FOREIGN BROADCAST GUIDE.

BELGRADE

(Yugoslavia).

Geographical Position: 44° 47' N. 20° 26' E.
Approximate air line from London: 1,055 miles.

Wavelength: 432.3 m. Frequency: 694 kc. Power: 2.5 kW

Time: * Central European (one hour in advance of G.M.T.).

* B.S.T. coincides with C.E.T.

Standard Daily Transmissions.

09.00 B.S.T. (Sun.) relay of Sacred Service from the Cathedral; 10.30 gramophone records; 12.20 luncheon concert and news; 18.00 talks; concert; 20.00 main evening programme.

Female announcer only. Call: *Hallo! Hallo! Radio Beograd.*

Opening announcements are made in the Serbian, German, French and English languages.

Interval signal: Metronome (1 beat per second). The hollow sound is somewhat reminiscent of an Indian tom-tom.

Station usually closes down at about 23.00 with words *Laki Noc* (Good night) and, if at full hour, with clock chimes and carillon.

Belgrade frequently relays Vienna broadcasts and takes in the International programmes transmitted by Austria, Germany, Hungary, Czechoslovakia and Poland. On some evenings transmissions are S.B. from Ljubljana and Zagreb.

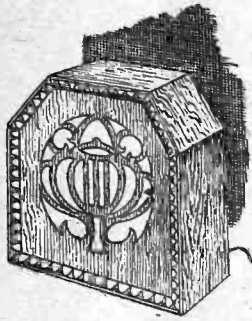

Everybody's
calling for

*Player's
Please*



The **BENJAMIN**
Turntable
with folding legs
is unique

FOR Outdoor or Indoor use, the new Benjamin ball-bearing turntable is invaluable to the Portable Set user. Used outdoors, the legs are opened out, the capacity of the set to earth being thus considerably reduced. For indoor use the legs are folded, and being fitted underneath with rubber buffers, all damage to furniture is prevented. The smooth-running ball bearings make "direction finding" easy.

Price **7/6** complete.

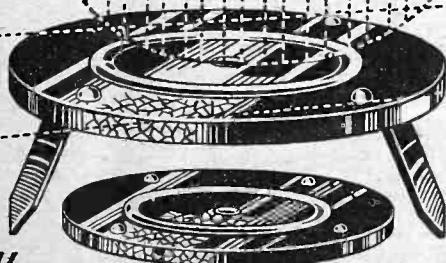

Write for illustrated leaflets on all Benjamin radio products.

Buy
BENJAMIN
and buy the Best!

THE BENJAMIN ELECTRIC LTD. BRANTWOOD WORKS, TOTTENHAM, N.17.

*An additional
refinement*

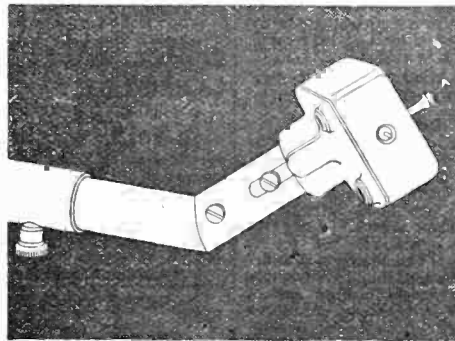
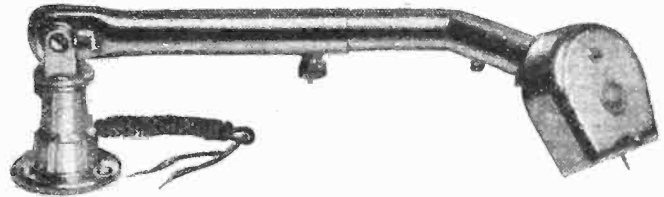

STILL THE
SAME PRICE

45/-

The B.T.H. pick-up holds a reputation second to none for excellence and efficiency. Now, with this latest development in the design of the B.T.H. Tone Arm, the complete accessory forms a masterpiece of ingenuity, combining perfect tracking, a feature of B.T.H. pick-ups, with the new arrangement which facilitates the changing of needles. The combination of the B.T.H. pick-up and the B.T.H. Tone Arm ensures a minimum of record wear and excellent tonal quality.



**PICK-UP
& TONE ARM**

From all Radio Dealers.



THE EDISON SWAN ELECTRIC CO., LTD.,
Radio Division,
1a Newman Street, Oxford Street, W.1.
Showrooms in all the Principal Towns.

EDISWAN

W.78

MISCELLANEOUS ADVERTISEMENTS.

NOTICES.

THE CHARGE FOR ADVERTISEMENTS in these columns is:

12 words or less, 2/- and 2d. for every additional word.

Each paragraph is charged separately and name and address must be counted.

SERIES DISCOUNTS are allowed to Trade Advertisers as follows on orders for consecutive insertions, provided a contract is placed in advance, and in the absence of fresh instructions the entire "copy" is repeated from the previous issue: 13 consecutive insertions 5%; 26 consecutive, 10%; 52 consecutive, 15%.

ADVERTISEMENTS for these columns are accepted up to **FIRST POST ON THURSDAY MORNING** (previous to date of issue) at the Head Offices of "The Wireless World," Dorset House, Tudor Street, London, E.C.4, or on **WEDNESDAY MORNING** at the Branch Offices, 19, Hertford Street, Coventry; Guildhall Buildings, Navigation Street, Birmingham; 260, Deansgate, Manchester; 101, St. Vincent Street, Glasgow, G.2.

Advertisements that arrive too late for a particular issue will automatically be inserted in the following issue unless accompanied by instructions to the contrary. All advertisements in this section must be strictly prepaid.

The proprietors retain the right to refuse or withdraw advertisements at their discretion.

Postal Orders and Cheques sent in payment for advertisements should be made payable to **ILIFFE & SONS Ltd., and crossed** Notes being untraceable if lost in transit should not be sent as remittances.

All letters relating to advertisements should quote the number which is printed at the end of each advertisement, and the date of the issue in which it appeared.

The proprietors are not responsible for clerical or printers' errors, although every care is taken to avoid mistakes.

NUMBERED ADDRESSES.

For the convenience of private advertisers, letters may be addressed to numbers at "The Wireless World" Office. When this is desired, the sum of 6d. to defray the cost of registration and to cover postage on replies must be added to the advertisement charge, which must include the words Box 000, c/o "The Wireless World." Only the number will appear in the advertisement. All replies should be addressed No. 000, c/o "The Wireless World," Dorset House, Tudor Street, London, E.C.4. *Readers who reply to Box No. advertisements are warned against sending remittance through the post except in registered envelopes; in all such cases the use of the Deposit System is recommended, and the envelope should be clearly marked "Deposit Department."*

DEPOSIT SYSTEM.

Readers who hesitate to send money to unknown persons may deal in perfect safety by availing themselves of our Deposit System. If the money be deposited with "The Wireless World," both parties are advised of its receipt.

The time allowed for decision is three days, counting from receipt of goods, after which period, if buyer decides not to retain goods, they must be returned to sender. If a sale is effected, buyer instructs us to remit amount to seller, but if not, seller instructs us to return amount to depositor. Carriage is paid by the buyer, but in the event of no sale, and subject to there being no different arrangement between buyer and seller, each pays carriage one way. The seller takes the risk of loss or damage in transit, for which we take no responsibility. For all transactions up to £10, a deposit fee of 1/- is charged; on transactions over £10 and under £50, the fee is 2/6; over £50, 5/-. All deposit matters are dealt with at Dorset House, Tudor Street, London, E.C.4, and cheques and money orders should be made payable to Iliffe & Sons Limited.

SPECIAL NOTE.—Readers who reply to advertisements and receive no answer to their enquiries are requested to regard the silence as an indication that the goods advertised have already been disposed of. Advertisers often receive so many enquiries that it is quite impossible to reply to each one by post.

"WIRELESS WORLD"

INFORMATION COUPON

This Coupon must accompany any Question sent in before

AUGUST 6th, 1930

For Particulars of Free Service, see Rules on page 113.

WITHOUT FEAR—

Send your material for credit—where radio part exchange began. A service ruled only by economics, above bargaining or petty gain.

Particulars from the Secretary,
HONOR OMNIA APPLEYB'S,
Chapel St., Marylebone, London

SUPER

SEND TO-DAY FOR OUR FREE 36-PAGE BOOKLET "SOUND ADVICE."



The Finest High-grade Speaker in the World

PERFECT RECEPTION FOR MUSIC LOVERS

BAKER'S 'Selhurst' RADIO

Offices: 89, Selhurst Rd., S. Norwood, S.E.25.
Works: 42, Cherry Orchard Rd., E. Croydon.

Super Power Moving Coil Speaker.

LOGGING MADE EASY

By the **POLAR TUNING GRAPH** which enables you to record and immediately identify any station by its wavelength.

Send 2/6 stamp to Dept. W,
WINGROVE & ROGERS Ltd.
188-9, Strand, London, W.C.2



POLAR

72 PAGE CATALOGUE

Crammed with illustrations and details of all sorts of fascinating and useful gear, at very reasonable prices.

RADIO ELECTRICAL SCIENTIFIC INSTRUMENTS MOTORS GENERATORS

Just send a stamped envelope.

ELECTRADIX RADIOS,
218, Upper Thames Street, E.C.4.
City 0191. Electradix, Cent, London.

BONA FIDE TRADERS' GUIDE.

Send for our comprehensive Illustrated List. **QUICK SERVICE. QUICK SERVICE.**

THE QUALITY HOUSE.

PERSEUS MFG. CO., LTD. (Dept. W.W.).
BRANSTONE RD., BURTON-ON-TRENT.



TILTRACK
Registered Trade Mark

Patent STEEL STORES System

For the Wireless Experimenter, Factory, Factor and Retailer,
Full Particulars from Sole Manufacturer and Patentee:—
BERTRAM THOMAS, Worsley Street, Hulme, MANCHESTER.

IMPORTANT NOTICE.

Owing to the August Bank Holiday, the next issue of "THE WIRELESS WORLD" (dated August 6th) is closing for press earlier than usual.

In accordance with the Notice that appeared last week, the latest date upon which Miscellaneous Advertisements could be accepted for the above issue was **FIRST POST, WEDNESDAY, July 30th.**

ACCUMULATORS—BATTERIES.

ZINCS.—Best quality (wired), No. 1, 8d. per doz.; No. 2, 9d. per doz.; orders valued 5/- carriage paid, otherwise 6d. for postage.—British Battery Co., Clarendon Rd., Watford, Herts. [0258]

ACCUMULATOR HIRE.

DON'T Buy Accumulators or Dry Batteries, join our C.A.V. low- and high-tension accumulator hire service, the largest and best in London; better and cheaper reception with no trouble; regular deliveries within 12 miles of Charing Cross; no deposit, payment on each delivery or by quarterly subscription; over 10,000 satisfied users; explanatory folder post free; phone or write to-day.—Radio Service (London), Ltd., 105, Torrington Av., N.W.5. Phone: North 0623-45. [8751]

RECEIVERS FOR SALE.

SCOTT SESSIONS and Co., Great Britain's Radio Doctors.—Read advertisement under Miscellaneous. [0264]

HIRE a McMichael Portable Set, by day or week, from Alexander Black, Wireless Doctor and Consultant, 55, Ebury St., S.W.1. Sloane 1655. [0328]

MAGNIFICENT Cabinet Set, 36in. high, absolutely modern 6-valve superb, drum dials, complete with frames, valves, cone, loud-speaker, high and low tension accumulators, and high tension charger, a most efficient set and in perfect order, in Jacobean oak cabinet, space for books and papers; £12.-6, Lancaster Park Rd., Harrogate. [1083]

McMICHAEL Screened Dimic Three, as new, extra coils for ultra short waves, 20/100 metres; £15.—Swallow, The Beacon, Newport Rd., Sandown, I.W. [1080]

HALCYON Portable De Luxe 5-valve Cabinet, as new; cost 37 guineas, accept 18 guineas.—Apply Cecil, 91, Houndsditch, E.C.3. [1079]

ALL-BRITISH Six Wireless Set, complete in cabinet containing Coleston loud-speaker, will work off frame or outside aerial, 40 stations, 6 valves; £8.—L. C. A. D., 18, Berkeley St. Mayfair 7050. [1071]

G.E.C. 28.G. World Wide Four, frame aeriels, Kabinok cabinet, M.C. speaker, accumulators; £27, cost £50; exchange A.C. radiogram.—Box 6952, c/o The Wireless World. [1065]

FOR Sale, 5-valve Pye portable set, 2 extra accumulators, nearly new, guarantee unexpired; owner leaving for U.S.A.; 15 guineas. or near offer.—Box 6922, c/o The Wireless World. [1062]

LOOK! Manufacturers stock!—Complete 3-valve A.C. and D.C. all main sets, 110-220v., quality component; easy terms; £10.-96, Brockley Rise, S.E.23. [1081]

BERCLIF D.C.2 All Mains Receiver, 200 to 250 volts D.C.; price £14/10; with valves and royalties, suitable for M.C. speaker; particulars free; trade inquiries specially invited.—Simmonds Bros., Shireland Rd., Smethwick. [8734]

YOUR Old Receiver or Components Taken in Part Exchange for New; write to us before purchasing elsewhere, and obtain expert advice from wireless engineer of 25 years' professional wireless experience; send a list of components or the components themselves, and we will quote you by return post; thousands of satisfied clients.—Scientific Development Co., 57, Guildhall St., Preston. [0226]

MARCONI 5-valve Portable, model 55, walnut, new, complete; for £12/10.—Taylor, 110, Goswell Rd., E.C. [1086]

Mention of "The Wireless World," when writing to advertisers, will ensure prompt attention.

Receivers for Sale.—Contd.

APPLEBY'S.

WHERE Radio Part Exchange Began; a service under the patronage of notabilities and men of consequence all over the world which has accurately handled the requisitions of over 25,000 people, 84% of whom have repeated their first transaction.

THE Service is as follows: We can supply practically all the leading lines of radio apparatus on the market at current list prices; if so desired we can accept in part exchange the reputable makes of the following apparatus: Receivers (domestic and portable), radio-gramophones, loud-speakers (cone and moving coil), cone units and chassis, battery eliminators and mains equipment components, battery chargers, remote control equipment, pick-ups and carrier arms, electric gramophone motors, H.F., L.F., and power chokes, condensers (variable, reaction, by-pass and smoothing), measuring instruments (high grade), L.F. transformers, slow motion dials (high grade), modern miscellaneous components; valves and tuning coils cannot be accepted in part exchange except by special arrangement.

IN View of the Difficulty of Making Fair and Definite Offers for Material that we have not inspected, it is requested that apparatus tendered for part exchange be kindly forwarded to us for valuation; no business can be proceeded with in connection with part exchange until material tendered has been examined; in this connection there need be no fear, material is sent to us from all over the world, not a single item of customers' property has ever been lost or mislaid; rejected offers from Xmas last amount to only 3.

IN Order to Furnish a Guide, the part exchange allowance may be gauged as approximately 50% of the list price of the article or articles tendered; for some articles the allowance will be more, and for others somewhat less; the allowance is entirely determined by the demand for individual articles, considering also their condition and production age; amateur constructed receivers cannot be accepted in part exchange as receivers, their value lying wholly in the components contained in them; only modern apparatus in good condition is accepted in part exchange; material cannot be purchased by us for cash.

TERMS of Part Exchange Business: A minimum of 50% of the value of an order, plus carriage charge where due, is payable in cash, unless the value is below £1, when a minimum of 10s. is payable; should the part exchange allowance exceed 50% of the total value of new requirements, the difference will be credited against future orders; material may be deposited against a credit note, which may be utilised at a later date; the maximum amount allowed to stand to the credit of any one individual is £200.

THESE Terms Have Been Made to the Lowest Economic Minimum, to give the customer the best value possible, while enabling us to maintain the standard required of this business.

SPECIAL Notice is drawn to the fact that by stipulating a minimum of 50% cash payable on part exchange orders, which is the same as stating that the part exchange allowance is credited to an order for not less than twice the allowance, you are ensured always of the best offer, as obviously, the more we allow you the more you ultimately spend with us, to utilise your credit, if for no other reason; note also the facility of depositing material against a credit note, it can be drawn upon as required wherever you may be; credit notes worth many thousands of pounds have been duly honoured upon presentation; a credit note on Appleby's is saleable, should the necessity arise, providing notice of transference is lodged with us at the time of sale.

AS Soon as Apparatus is Discarded from Use, dispose of it, don't keep it; it is not only wasteful, but expensive; the longer you keep it the older it is, and the older it is the less value it is; exchange it for a part exchange credit note, the value of which is constant, and can be disposed of if necessary by the holder with greater ease and facility than an article or collection of articles can ever be.

YOU Will Do Well to Deal with Appleby's; there is more in part exchange than the mere allowance; there is that something which begets confidence, that care that makes for efficiency; in the recent words of an old customer: Quite an embarrassing aloofness of purpose and an almost monotonous accuracy; you will know that it is all British—British capital and British behaviour; you will know also by dealing there that you are helping to employ British people.

SINCE the Day This Service Started it has Steadily Grown, not on rash advertising or subscribed capital, but on the volume of attainment only; and in these days businesses do not grow by that means for nothing, therefore we are privileged to invite you to utilise this service, wherever you may live; if you send your material by a carrier, pack it well, carriers are only human, and it is better to be safe than sorry; if you live in London, call to see us, you will like the atmosphere, it savours more of sport and art than the searing curriculum of commerce.

APPLEBY'S, Chapel St., St. Marylebone, London (opposite Edgware Rd. Metropolitan Station, or 4 minutes from Marble Arch, Oxford St.). Tel.: Paddington 8828 (3 lines). [0340]

CHARGERS AND ELIMINATORS.

CHESTER BROS.—All types of mains transformers and chokes to any specification.—Chester Bros., 244, Dalston Lane, London, E.8. [9798]

TANTALUM and Litionium for A.C. Rectifiers; for inexpensive chargers; blue prints for H.T. and L.T., 1/- each; Litionium electrodes, 2-3 and 5-8 amps.—Blackwells Metallurgical Works, Ltd., Garston, Liverpool. [8298]

Success is assured!

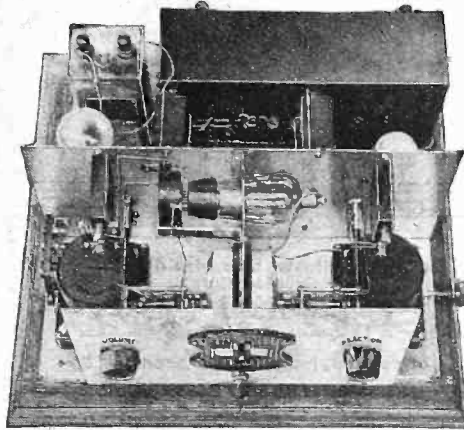

Build the Lotus S.G.P. Battery Set.

The success of a set depends on the efficiency of each individual component. The Lotus S.G.P. Battery Kit uses the famous Lotus Components, each one of which works in complete harmony with its neighbours. This remarkably efficient 3-valve set is simple to build: all the main components are already mounted in position to save you time and to ensure success.

Full diagrammatic details supplied with each Kit.

Price: £7-12-6 (excluding valves, cabinet and batteries) or 14/9 down and 11 similar monthly instalments.

Full details on request.

LOTUS 3-VALVE SET KIT

Garnett, Whiteley & Co., Ltd., (Dept. W.W.9) Lotus Works, Mill Lane, Liverpool.

Causton

Chargers and Eliminators.—Contd.

PHILIPSON'S Safety High Tension Supply Units for A.C. and D.C. Mains, 200-250 volts 40-60 cycles, also 230 volts 25 cycles.

10/- Down and Small Monthly Payments Secures the Finest H.T. Supply Available.

PHILIPSON'S Safety H.T. Units are Guaranteed for 12 Months Against All Defects.

ALL Models Sold on 7 Days' Approval to Ensure Complete Satisfaction.

PHILIPSON'S Safety H.T. Units are the Cheapest to Install and the Cheapest to Run; £1/17/6 to £6.

WRITE for Our Booklet, "Radio Power," which gives illustrations and full particulars.

PHILIPSON'S Safety Loud Speaker Output Filters for All Receivers, power valve, or Pentode; a remarkable output filter at a very low price; 16/6.

PHILIPSON and Co., Ltd., Radio Engineers, Astley Bridge, Bolton. Phone: 2038 Bolton. [0318]

ELIMINATOR Kit Ready for Wiring.—The Westinghouse 20 milliamp, 120 volt model kit consists of transformer, choke, Westinghouse rectifier, 8 mfd.'s of condensers, 2 resistances for S, G, and detector.

SUPPLIED, screwed to baseboard and safety plugs and sockets mounted.

CRACKLE-ENAMELLED Metal Case is Supplied Ready to Screw to Baseboard.

ONLY Requires Wiring to Drawing Supplied, and can be used within 15 minutes.

GUARANTEED for 12 Months, and sent on 7 days' approval against cash; no risk whatever; the postage is paid, and the whole outfit ready to wire is 60/-.—Fel-Ectric Radio, Garden St., Sheffield. 19963

ELLISON MANFG. Co., Ltd., for better value in soundly constructed and designed mains equipment; write us for quotations for any size or quantity of transformers or chokes; special prices for quantities.

THIS Week's Special Lines: Transformers for H.T.3 metal rectifiers, 200, 230, 250 volts A.C. input, 135 volts 20 milliamps output, 15/-.

FILAMENT Heating Transformers, universal input 4v., 5a. output, can be used with confidence with 3, 4 or 5 one amp. valves, as regulation is exceptionally good; only 19/6.

LISTS and Quotations from the Ellison Manfg. Co., Ltd., Dragon Works, Harrogate. Phone: 4680. [1072]

EKCO All Power Unit, C.I.A., D.C., £9/15 list, as brand new, unpacked; £6.—Martin, 3, Belfield Rd., Didsbury, Manchester. [1063]

B.T.H. Tungar L.T. Charger, 220 volts, 40-50 cycles, output 15 volts 2 amps., good condition; cheap.—Iverson, 17, Cavendish Rd., London, E.4. [1061]

TRANSFORMERS: Ready Power London.—Transformers and chokes for eliminators and chargers; the best and cheapest British made; list free.—Lallemant, 5, Charles St., Hatton Garden, London, E.C.1. [1030]

SAVAGE'S Specialise in Wireless Power from the Mains; reliable apparatus at reasonable prices.

SAVAGE'S.—Transformer laminations and Bakelite bobbins; intending home constructors should write for list.

SAVAGE'S.—Reliable smoothing condensers, 1,500 volt D.C. test, 1 mfd., 2/-; 2 mfd., 3/-; 4 mfd., 5/3; 500 volt D.C. test, 1 mfd., 1/6; 2 mfd., 2/3; 4 mfd., 3/9.

SAVAGE'S.—Super smoothing and output chokes, many types available; write for list.

SAVAGE'S.—Mains transformer for Westinghouse H.T.4 unit, with additional winding, 4 volts centre tapped 3 amps, 23/-; transformers for other Westinghouse units available.

SAVAGE'S.—Mains equipment for new Foreign Listeners: Four, transformer N.F.L.4, 33/-; smoothing choke, C32G, 20/-; output choke C32O, 20/-.

SAVAGE'S.—Mains equipment for Power Pentode No. 2 transformer, P.P.2, 33/-; output choke, L.C. 36P.G., 19/6; smoothing choke, L.C.36G, 18/-.

SAVAGE'S.—Mains transformer B.T.4, 500-0-500 volts, 120 m.amps, 7½ volts 3 amps., 6 volts 3 amps., 4 volts 2 amps., 4 volts 1 amp., 4 volts 1 amp., all centre tapped, specially developed for automatic bias; 57/6.

SAVAGE'S.—Mains transformers and power chokes are carefully and individually constructed from first class materials, with an exceptionally generous margin of safety.

SAVAGE'S, 146, Bishopsgate, London, E.C.2. Phone: Bishopsgate 6998. [9165]

RADIELLE 400-volt 60 m.a. Eliminator (200-250 A.C.); cost £12, sell £3; complete, brand new; bargain.—Priestley, 8, Grosvenor Gardens, Muswell Hill, London, N.10. [1105]

PHILIPS Charger, 200-230 volts, 50 cycles, output 12 volts 1.5 amps., 120 volts 90 milliamps; £3.—21, Avenue Crescent, Leeds. [1094]

EKCO ½ amp. Charger, 26/-, cost 52/-; Ekco H.T. unit, 60 m.a., 60/-, cost 153/-; Marconi D.C.3 unit, 20/-, cost 35/-; Marconi D.C.2 unit, 30/-; Fellows ¼ amp. charger, 25/-; Repophone crystal set, 10/-; 2-valve set, complete with coils and valves, 36/-—80, Wolfington Rd., S.E.27. [1102]

UNIVERSAL RADIO EXCHANGE SERVICES, 15, Princes St., Harrogate, will sell or exchange it for you. [1113]

CABINETS.

CABINETS for All Requirements.—F. W. Ramsey, 63, Shaftesbury St., London, N.1. Clerkenwell 7139. [9736]
DIGBY'S Cabinets.—Table models in solid oak and mahogany; from 11/6 to 71/-.
DIGBY'S Cabinets. fitted with Radion or Resiston ebonite if required.
DIGBY'S Cabinets.—Pedestal model, with separate battery components; from 56/- to £12.
DIGBY'S Cabinets Made to Customers' Own Designs.
DIGBY'S Cabinets.—Write for new 16-page art catalogue.—F. Digby, 9, The Oval, Hackney Rd., E.2. Phone: Bishopsgate 6458. [0128]
SUITCASE Portable Cases, N.P. fittings, covered imitation leather, including polished oak fret and aerial frame, any colour, any size, 30/-; in real brown crocodile grained leather, £2; give inside measurements when ordering; cash with order.—Fitzroy Electric Co., 32, Howland St., London, W.1. [1078]

COILS, TRANSFORMERS, ETC.

TRANSFORMERS and Chokes for Battery Eliminators.—Chester Bros., 244, Dalston Lane, London, E.8. [9706]
FERRANTI A.F.3, 12/6; Ignac G., 15/-; Met-Vic. B.H.T. eliminator transformer, input 100-110v., 17/-.—Smith, 50b, Courtfield Gardens, S.W.5. [1074]
SCREENS (Aluminium), cylindrical, for Foreign Listener's Four coils, correct dimensions; set of 3, 5/6; sent c.o.d.—Lallemand, 5, Charles St., Hatton Garden, London, E.C.1. [1029]
BAND-PASS Four, Coils, complete, 80/-; Ideal Home receiver coils, complete, 43/-; superhet. adaptor coils and base, 24/-; S.G. S.W. Three, 4 coils, 34/-; 4 additional, 46/-; Bercili coils from stock for all popular sets; trade supplied.—Simmonds Bros., Shireland Rd., Smethwick. [9941]
600 and 1,000 ohms Decoupling Resistances, specified for the largest and most important "Wireless World" receivers; 1/6 each, post free.—Groves Brothers, St. Mary's Place, Shrewsbury. [1088]

KILO-MAG Four Formers, slotted, ready for winding, 12/6 set; 1930 Everyman Four, 8/6 set, post free.—Groves Brothers, St. Mary's Place, Shrewsbury. [1089]

BAND-PASS. Band-Pass. Band-Pass coils wound to "Wireless World" specification, complete set wound with Lewcos wire, 42/-; long wave only, 15/-; formers only, L.W. and S.W., 12/6 set.—Below.

SPECIAL H.F. Chokes, astatically wound with Lewcos wire on turned genuine ebonite, specially designed for S.G. circuits; 2/6.—Sound Sales, Tremlett Grove, Highgate. [1096]

TRANSFORMERS.—Marconi power model A, 120-240, 40 m.a., 14/-; Ferranti A.F.3, 12/-; Varley output, push-pull, 10/6.—Riley, 18, Westland Rd., Watford. [1092]

DYNAMOS, ETC.

CRYPTO Charging Plant, complete, 220v. A.C., £25; 6-valve superhet, with valves, £8.—BM/EBGR, London, W.C.1. [1070]

GRAMOPHONES, PICK-UPS, ETC.

B.T.H. Pick-up and Tone Arm, latest type, used once; 25/-.—Box 6903, c/o The Wireless World. [1058]

MARCONIPHONE Pick-up, latest pattern, perfect; £2/5.—Brunton, 240, Earl's Court Rd., S.W.5. [1095]

NEW Cabinet Gramophone, Era motor, exponential horn, crescent balanced arm, fibre tuned Meltrope; offers.—8, Kinfauns Rd., S.W.2. [1097]

ONE Amplion Pick-up and Tone Arm, new; 25/- cost 40/-.—80, Wollington Rd., S.E.27. [1103]

B.T.H. Pick-up and Arm (straight), 15/-; Garrard D.S. motor, 15/-; and Celestion C2 (mahogany), £2/10; all perfect.—Herbert, 17, Lewis Rd., Southall, Middlesex. [1100]

UNIVERSAL RADIO EXCHANGE SERVICES for the Best Selection of New and Second-hand Radiogram Components.—Write to 15, Princes St., Harrogate. [1114]

TRANSMITTERS.

QUARTZ Lenses, 320 metre band, 4/-; calibrated for doubling to 160 metre band.—Smith, Bryn Rodyn, Colwyn Bay. [1090]

LOUD-SPEAKERS.

MAGNAVOX Moving Coil Speaker, 230 D.C., £4; 2 Marconiphone 50 henries power chokes, 15/- each; Pye 3z henries choke, 7/6.—Bayley, Lynton, King's Rd., Clacton. [1091]

BAKER'S SELHURST RADIO 36-page Booklet. "Sound Advice is Yours for the Asking"; write now for new edition; see displayed advertisement on page 8. [0231]

AMPLION Guinea Cone, as new, perfect, mellow tone; 10/6.—21, Randall Av., N.W.2. [1075]

UNIVERSAL RADIO EXCHANGE SERVICES Have that Loud-speaker You Want, or will dispose of yours.—Write now to 15, Princes St., Harrogate. [1115]

Specified
for the
**"BAND PASS"
FOUR.
MAGNUM
ALUMINIUM
SCREENING BOXES**

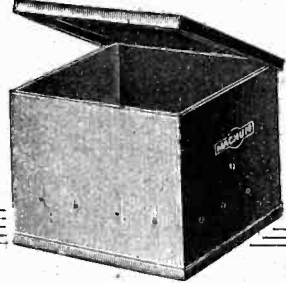

Similar to illustration, size 4 1/2" x 6 1/2" x 6"
Frosted finish.

PRICE 5/- EACH

or set of 5, including baseboard, 25/-.

We specialise in the "BAND PASS" FOUR and can supply as a constructional kit, ready wired and tested, or parts separately. Full particulars and interesting literature free on request.

**BURNE-JONES
AND COMPANY LIMITED,**

"Magnum" House, 296 Boro' High Street, London, S.E.1
Telephones: Hop 6257 & 6258.

IN
**"RADIO FOR THE
MILLION."**

Pat.
**Belling-Lee 9-way Battery Cord with
Belling-Lee Wander Plugs and Spade
Terminals.**

5/9

Also specified:—**Belling-Lee
Terminals** - - - Price 6d.

BELLING-LEE
FOR EVERY RADIO CONNECTION

*Advertisement of Belling & Lee Ltd.,
Queensway Works, Ponders End, Middlesex.*

EXACT TUNERS

200 to 2,000 metres.

No further coils are required, tuning is as simple as A.B.C., see "Wireless World," January 25th: "We can strongly recommend these tuners." Send postcard for particulars and Circuits FREE to

THE EXACT MANUFACTURING CO.
Croft Works, Priory Place, COVENTRY.

Loud-Speakers.—Contd.

EPOCH Moving Coil Speakers are Masterpieces, designed and produced by master engineers.
EPOCH Moving Coil Speakers are the Standard by which other Speakers are Compared.
EPOCH Moving Coil Speakers are in Use in Many Editorial Offices.
EPOCH Moving Coil Speakers are in Use in Several Famous Laboratories.
EPOCH Moving Coil Speakers are in Use in Many Broadcast Stations.
EPOCH Moving Coil Speakers are in Use by Most Prominent Musicians.
EPOCH Moving Coil Speakers Bring Unbounded Joy to Thousands upon Thousands of Homes.
EPOCH Moving Coil Speakers, the only speakers that give clear, uncoloured reproduction.
EPOCH Moving Coil Speakers do Render Speech Perfectly and Music Correctly.
EPOCH Moving Coil Speakers Provide the Perfect Illusion of the Artist's Presence.
EPOCH Moving Coil Speakers Represent the Finest Intrinsic Value Ever Offered.
EPOCH Moving Coil Speakers are Guaranteed for a Year, but last for ever.
EPOCH Moving Coil Speakers Bring the Grand Concert out of the Most Modest Set.
EPOCH—You can hear a hundred moving coil speakers, but Epoch is different.
EPOCH—If you own the best set, only by Epoch can you confirm it.
EPOCH—Away with the tin can and cracked banjo reproduction, and install an Epoch.
EPOCH—Away with the drumminess, droniness, and huskiness of the average moving coil speakers.
EPOCH—The clearest, sharpest, cleanest, reproduction—a marvel of accuracy and beauty.
EPOCH Moving Coil Speaker Models from £2/10 to £30.
EPOCH Moving Coil Speakers.—Models for every requirement and taste.
EPOCH Permanent Magnet Moving Coil Speakers.—Nine models from £3/15.
EPOCH Permanent Magnet Moving Coil Speakers Require no Mains or Batteries.
EPOCH Permanent Magnet Speakers are more Sensitive than most Energised Moving Coil Speakers.
EPOCH Energised Models are the Finest ever put on the Market.
EPOCH Super Cinema Speaker has Created the Biggest Sensation for Many Years.
EPOCH Super Cinema Model is many times as Sensitive as the so-called Supers.
EPOCH Super Cinema Speakers give Enormous Volume from a 1-watt Amplifier.
EPOCH Super Cinema Speakers are used on many 100-watt Amplifiers and never "rattle."
EPOCH Super Cinema Model is Standard on several Talkie Equipments.
EPOCH Super Cinema Model is already in use in over 200 Cinemas.
EPOCH Super Cinema are the only Moving Coil Speakers used in Large Theatres, unaided.
EPOCH Super Cinema Speakers provide alone the Upper as well as the Lower Register.
EPOCH—Other Moving Coil Speakers require the help of exponential horns to provide depth.
EPOCH—A list of many prominent cinemas using the Speakers supplied on request.
EPOCH Speakers are not Made of Tin or Aluminium Stampings, but are sound, solid, engineering jobs.
EPOCH Heartily Invite Comparison, on all counts, with any make, regardless of price or claims.
EPOCH—Don't accept our quality claims without verification, but don't accept any other maker's either.
EPOCH—Order one on 7 days' approval, and test with a switch-over; the only real test.
EPOCH Moving Coil Speakers may be heard in our Demonstration Room Daily.
EPOCH—Our demonstration room is in the heart of London.
EPOCH—Its accessibility has been studied for the convenience of callers.
EPOCH—If you cannot call, write for booklet W.S.3, and approval terms.
EPOCH RADIO MANUFACTURING Co., Ltd., Farringdon Av. (near Ludgate and Holborn Circuses). Phone: Central 1971. [8983]

Mention of "The Wireless World," when writing to advertisers, will ensure prompt attention.

VALVES.

AMPLIFIER Valve.—If you require power you cannot do better than one of these (or matched in pairs if required).
FILAMENT Volts 6, plate volts 400 (maximum), grid bias 84 volts (approx.), impedance 800 ohms, amplification factor 3.8, mutual conductance 4.35 m.a./volts; price £5/10; see article "The Wireless World," 24th July, 1929, then send to North London Valve Co., Ltd., 22½, Cazenove Rd., Stoke Newington, London, N.16. [9964]

COMPONENTS, ETC., FOR SALE.

BELLING-LEE Panel Fittings are designed to give an expert finish to any home-constructed set; catalogue post free.—Belling and Lee, Ltd., Queensway Works, Ponders End, Middlesex. [0018]

COMPONENTS Lent on Hire.—Details from Alexander Black, Wireless Doctor, 55, Ebury St., S.W.1. Sloane 1655. [0329]

AMATEUR'S Surplus.—J.B. drum dial, 6/-; Gilman chassis, 9/-; Amplion B.A.2 unit, 13/6; Blue Spot 66p. as brand new, 20/-; P.M.22 pentode, 10/-; H.L.210 and L210, 6/- each; Pye reaction 0.0001, 3/-; following all Lissen, super transformer, 11/-; needle armature pick-up, 25/-; volume control, 3/-; 2 0.0005 variable, 4/- each; offers for any or all considered.—G. A. Thearle, Freshwater. [1084]

FOR a Big Country House Set: Crypto rotary converter, 50v./230v. 150 m.a., just overhauled by makers, £12/10; 5 Exide W.H.60 batteries, perfect, 25/- each, £5 all; 2 Ferranti B1 chokes, 10/-; R.I. 100 henry, 7/6; P.M.24A, 12/6; A.C./R. and holder, 7/6; Record III aerial and H.F. coils, 20/-; cabinet and container, with switches and 2 condensers, 35/-.—Milford, Cyona, Didcot. [1073]

SCREENS, for Foreign Listener's Four, 1930, valve screens, 3/-; coil screens, 2/9; choke screens, 2/6 each; aluminium baseboards, 2/6; send for lists, post free.—Loud-speaker Co., Ltd., 2, Palmer St., S.W.1. [1067]

RADIO HOUSE, HUDDERSFIELD, issues the Reliability Wireless Guide, which will be sent post free upon request by Messrs. J. H. Taylor and Co., 15, Macaulay St., Huddersfield. [7823]

PART Exchange.—See our advertisement under Receivers for Sale.—Scientific Development Co., 57, Gaidhall St., Preston. [0228]

ELECTRICAL Clearance.—2-valve transmitting sets, 15/-; Morse transmitting sets, 12/6; 1in. spark coils, 6/-; 2in. spark coils, 17/6; super microphones, 2/6; microphone transformers, 2/6; television motors, electric, 110 or 220v., D.C., 10/-; ¼h.p. motors, 110v., 30/-; 50v. 4a. dynamos, 35/-; 20v. 6a., 40/-; 100v. 10a, slow speed, £7; portable telephones, 17/6; ear-phones, 1/3; telephone H.T. generators, 6/6; Morse keys, 3/6; buzzers, 2/6; 1 mfd. condensers, 1/6; hand telephones, 5/-; shunt regulators, 10/- to £1, all sizes; 1,000 ohms chokes, 1/-; magnetic relays, 12/6; P.O. relays, 6/-; Ford ignition coils, 4/-; ¼h.p. 220v. motor, shunt wound, 50/-; Mark III Star crystal sets, 40/-; D.III buzzers, platinum contacts, 5/-; Dewar switches, 1/-; 12v. car dynamos, 25/-; 6 or 12v. car starter motors, 12/6; cash with order or c.o.d.; all goods guaranteed; send now, list now ready.—Galpin, Binfield Heath, nr. Henley-on-Thames. [1087]

80V. Exide, W.J., with G.E.C. electrolytic charger for 200v. A.C. mains; 45/-.—BM/XRPH, London, W.C.1. [1093]

METER, m.a. volts, 5 ranges, 45/-; motor, 110v. D.C., 12/6.—Ashman, 22, Kentish Town Rd., N.W.1. [1098]

GENUINE Bargains.—New B.T.H. army pick-up, 25/-; 4 ohms Paul unipivot galvo and thermal couple, L.S.5A valve, model 280 Weston 0.500 milliammeter, 301 voltmeter, 0.8 and 0.80, Marconi 0.003 variable condenser, 1in. heavy discharge induction coil, 2-0.00025 Hamerlund condensers, Siemens 3in. dial 0.6 ammeter and 0.150 voltmeter, 200 volt H.T. battery charger.—96, Laburnum Grove, Portsmouth. [1101]

HAVE You Any Apparatus to Dispose of?—Universal Radio Exchange Services will, either sell your surplus material for cash, or make a generous allowance against new or second-hand apparatus.

WE Have a Large Stock of Second-hand Components in Guaranteed Condition; let us know your requirements; lists free.

THIS Week's Special Bargains:—Pye 12/6 I.F. transformer, 7/6; pick-ups, Loewe, 12/-; Electravox, 14/6.

MAGNAVOX Moving Coil Speaker, new, £4; Fultograph, new, £5; Marconi D.C.2 eliminator, £2; Ferranti O.P.C. transformer, 17/6; large selection of mains transformers and condenser blocks, L.F. chokes, 40 m.a. at 30 henries, 6/6.

LARGE Assortment of Modern Valves, A.C. and battery types; very large quantity of variable condensers, 1/- upwards; Ultra 52/- speaker chassis, with handsome cabinet, 45/-; vast selection of fixed condensers, resistances, valve holders, speakers, gramophone motors, hand and electric, radiogram parts rectifiers, switches, tuners, coil holders, coils, and other components too numerous to mention; send us your enquiries and let us know what you have to dispose of.—Universal Radio Exchange Services, 15, Princes St., Harrogate. [1112]

WESTINGHOUSE H.T.4 Rectifier, 23/-; Magnavox X cone 6volt field under guarantee, £3/10; A.C./S.G., 14/-; P.M.24, 10/-; P.M.4D.X, 5/-; P.M.254, 8/-; as new.—27, Miles Hill Av., Leeds. [1106]

HIGHLY SENSITIVE SUPER-MICROPHONES

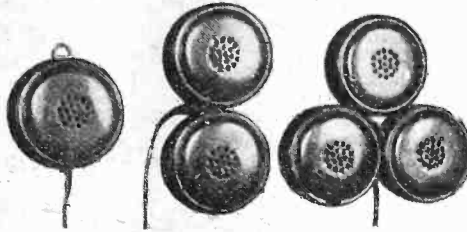

Entirely new, not Government surplus, made on the latest principle, a vast improvement over all other types; will take up whispered words from a distance of several yards, also strongly amplify and transmit speech and music over a distance through Loudspeaker or Headphones. Splendid instruments for making Detectors, DEAF-AID, LOUD-SPEAKING TELEPHONE, ANNOUNCEMENTS THROUGH LOUDSPEAKER (with or without Valve Amplifier), Electric Sound Detector, BABY ALARM, from Bedroom through distant Loudspeaker, Experiments, etc. NO OTHER MICROPHONE OF EQUAL SENSITIVENESS KNOWN; each instrument finely black enamelled and fitted with a 3-ft. silk connecting cord.

- SINGLE Super-Microphone - - 8/6
- DOUBLE " " (double range and volume of sound) 18/6
- TREBLE " " (treble range and volume of sound) 28/6

SPECIAL MICROPHONE TRANSFORMER for connecting Super-Microphone to Radio Headphones, Loudspeaker, Valve Amplifier or Wireless set 6/-

SMALL 10 OHMS EARPIECE for use with Super-Microphone as a HIGHLY EFFICIENT DEAF AID, or Detectors, etc.; thin 3-ft. silk connecting cord fitted, Earpiece 6/- Fine Black Enamelled 6/-

Full Directions for use of Super-microphone for many purposes and Diagrams of connections free.

FREDK. ADOLPH, Actual Maker, 27, Fitzroy Street, London, W.1
 Phone: Museum 8329.

METAL CABINETS
 for all Wireless World sets from 22/6. Aluminium screening boxes, all sizes, to order. Standard size from stock, 6x6x6½, price 4/- each.
W. H. PARKER, Sheetmetal Workers, Back Autumn Terrace, Leeds Tel. 52859.

Electrically sealed
METAL CABINETS
 Complete with Base for 1930 Everyman Four, New Kilogram Four, and W.W. Record III. Jacobean Finish.
 TERMS: CASH WITH ORDER Price 57/6.
RIGBY & WOOLFENDEN, SHEET METAL WORKERS, MILNROW RD., ROCHDALE.

REPAIRS
 Any make of L.F. Transformer, Loudspeaker or headphones repaired and dispatched within **48 HOURS—TWELVE MONTHS' GUARANTEE** with each repair. 4/- Post Free.
 Terms to Trade.
TRANSFORMER REPAIR CO.,
 Dept. W., 953, Garrett Lane, Tooting, London, S.W.17

Components, Etc., for Sale.—Contd.

MARCONI P625, 6/6; P625A, 6/6; Ferranti A.F.5, 17/6; Ignacik pick-up, 12/6; all perist.—Wood, 13, Brackenhall Rd., Sheppridge, Huddersfield. [1107]

MULLARD Permucore, 10/6; Wearite Titan coil, 7/6; Ignacik I.F. choke, type F, 7/6; Mullard P.M.1 H.P., 3/6; P.M.12, 7/6; Cossor 2-volt pentode, 8/6, new.—Sargent, 132, Landguard Rd., Eastney, Portsmouth. [1108]

MARCONI New Type Pick-up, £2; Hunt's ammeter, 0.25, 4/-; Parex Titan coil, 7/6; Lewcos Q.A.T., 7/6; pair Cossor coils, 6/-; Wearite louding coil, 4/6; pair Marco S.M. dials, 5/-; first class buzzer wave-meter, 12/6.

ORMOND Cone Unit, with classis, 13/6; Varley antimono, 5/-; Varley R.C.C. unit B, 5/-; Dubilier, 3/6; P.M., 3/6.

HARLIE Wave Trap, 5/-; Watmel new type tuner, 8/-; Ignacik dual impedance I.F. unit, 5/-; Clinax binoc choke, 4/-; Brandes head phones, new, 4/6; Ignacik S.W. coils, 5/- set; Lewcos S.W. coils, new, 2/9 each.

JUNIT Multi Switch, 4/-; Utility D.P.D.T. lever, 2/6; Lotus P.V. D.T.D.P., 2/6; 2 T.C.C. electrolytic condensers, 9/- each; 1 double, 17/-; Cossor L.F. transformers, 10/6 each; Ferranti A.F.3.C. 15/6; Hydra 2 mf., 1/6; ditto, 650v., test new, 2/-; Hydra 1 mf. 1,000v. A.C. test, 2/9; T.C.C. 4 mf., 500v., working, 5/6 each.

GARRARD D.S. Gramophone Motors, complete, No. 10A, 33/6 (list 53/6); L.S.5, 12/6; A.C./S. G., 12/6; A.C./H.L., 7/6; Cossor P215, 5/6; P.M.2, 3/9; P.M.12, 8/6; Marconi S215, 8/6; H.L.210, 5/-; Mullard S4v., 12/6; all guaranteed, as new.—G. A. Ryall, 182, Kennington Rd., London. [1104]

MISCELLANEOUS.

SCOTT SESSIONS and Co., Great Britain's Radio doctors, officially approved as wireless repairers by Radio Society of Great Britain and Wireless League; old sets of every type repaired, rebuilt, modernised; send set for immediate quotation.

SCOTT SESSIONS and Co.—New sets constructed with your or our components, guaranteed finest workmanship; we specialise in "The Wireless World" circuits; remember, we have satisfied customers throughout the British Isles and in three Continents; if you so desire, we will design and construct high grade apparatus to suit your special circumstances for quality, range and selectivity.—Tel.: Tudor 5326. Muswell Hill, London, N.10. [0262]

ALEXANDER BLACK,
THE Original Wireless Doctor, will call (London and Home Counties) and cure your set.
CONSULTATIONS by Appointment Without Obligation, sets installed, maintained, and brought up to date, gramophone pick-ups, eliminators, and Webson moving coil speakers demonstrated; purity reproduction specialists.
 55, Ebury St., Victoria, S.W.1. Sloane 1655. [0277]

EASY Payments.—We supply, by easy payments, components, accessories, and sets, any make; 10% down, balance spread over 11 months.—Send list of requirements to London Radio Supply Co., 11, Oak Lane, London, E.C.2. [0337]

COMFORTABLE Digs for Wireless Students Studying in London, good food; very moderate.—Moore, 41, Pinborough Rd., South Kensington, London, S.W.10. Phone: Kensington 1427. [9857]

ENGINEERS, novice or expert, £300, £400, £500 per year or more is within your grasp; in our handbook "Engineering Opportunities," Prof. A. M. Low explains where the good posts abound; this handbook has shown the way to better things to over 20,000 of your fellows; it contains details of A.M.I.Mech.E., A.M.I.E.E., A.M.I.C.E., A.M.I.A.E., A.M.I.Struct.E., A.M.I.C. and G., G.P.O., etc. exams, outlines home study courses in all branches of electrical, mechanical, motor, and wireless engineering, and shows the unique advantages of our appointments department; why stay in the Hammer and File Brigade? Send for our free handbook at once, stating branch, post or exam. which interests you.—British Institute of Engineering Technology, 87, Shakespeare House, 29-31, Oxford St., London, W.1. [9912]

PATENT AGENTS.

PATENTS and Trade Marks, British and foreign.—Gee and Co. (H. T. P. Gee, Member R.S.G.B. and A.M.I.R.E.), 51-52, Chancery Lane, London, W.C.2. Phone: Holborn 1525. [0001]

REPAIRS.

SCOTT SESSIONS and Co., Great Britain's radio doctors; read advertisement under Miscellaneous column. [0263]

THE BARNES RADIO SERVICE.—Repairs, rebuilding, demonstrations, radio gramophones and scratch filters; reproduction specialists; any distance.—53, High St., Barnes, S.W.13. Prospect 5633. [9705]

GUARANTEED Repairs by Experts.—Loud-speakers, headphones, cone units, pick-ups, any type, re-wound, remagnetised, and adjusted post free 4/-; transformers, from 4/-.—Howell, 91, Morley Hill, Enfield Middlesex. [9550]

TUITION.

TYPEWRITING, correspondence courses, technical literature, components and complete sets, are all dealt with; write for complete details; complete index system, 1/6.—Box 6888, c/o *The Wireless World*. [1053]

WANTED.

WIRING Circuit Marconiphone Type 81 Receiver.—Carpenter, 15, Blenheim Park Rd., Croydon. [1060]

WANTED, M.L. converter input, 12 volts.—Particulars to Box 6964, c/o *The Wireless World*. [1076]

WANTED, Master Three Star or similar set, also cone speaker; state prices.—W. Phillips, 12, Villiers St., Oldham. [1069]

WANTED, copies "Wireless World" for last 18 months; state price.—34, Melbourne St., York. [1099]

UNIVERSAL RADIO EXCHANGE SERVICES Want Your Surplus Apparatus in exchange for cash or other apparatus, new or second-hand.

WRITE Now for Particulars of Our Original Scheme for a Better Exchange and Sale Service.—15, Princes St., Harrogate. [1116]

BUSINESSES & PROPERTY FOR SALE, TO BE LET, OR WANTED.

WIRELESS Business for Sale, good prospects, splendid district; about £400, all in, or partnership.—6971, c/o *The Wireless World*. [1085]

SITUATIONS VACANT.

WIRELESS Operating; fees payable after appointment; amateur Morse classes.—Manager, Wireless School, 21, Manor Gardens, London, N.7. [9378]

WIRELESS Services.—The premier telegraph college in the British Isles (established 34 years) gives a sound training to all students, with assured positions on qualification; fees are not disguised under expensive board-residence scheme, but are payable by easy instalments, if desired.—Apply for Prospectus, Dept. "W.W.," The London Telegraph Training College, Ltd., Morse House, Earl's Court, S.W.5. [9877]

JUNIOR Engineer Wanted, by Talkie Equipment Firm, public school education (science side), with some knowledge of radio and general engineering; 3 guineas per week.—Apply by letter in first instance, stating age, qualifications, etc.; send copies only of testimonials.—Box 6951, c/o *The Wireless World*. [1064]

WE have a Vacancy for an Electrical Engineer conversant with the design and application of research and production test instruments used in the manufacture of radio apparatus.—Write, giving age and fullest details of technical training and experience, Murphy Radio, Ltd., Welwyn Garden City, Herts. [1068]

SALESMEN! Attention!!—Complete 3-valve A.C. and D.C. all mains sets; selling price £7/7, your commission £1/1; quality components.—96, Brockley Rise, SE.23. [1082]

SITUATIONS WANTED.

COLLEGE Trained Electrical Engineer Desires Reliable Post, 12 years radio, design and research work, 22 months' experience talking picture apparatus, film and disc; could develop new lines.—Box 6904, c/o *The Wireless World*. [1059]

RADIO Engineer, over 12 years' experience, free middle October, situation within 20 miles of Hayes preferred.—Box 6953, c/o *The Wireless World*. [1066]

YOUNG Man, 11 years' radio experience, first class P.M.G., requires situation with wireless firm, good general knowledge radio and experienced with all types of sets and components.—Box 6965, c/o *The Wireless World*. [1077]

BOOKS, INSTRUCTION, ETC.

TELEVISION—The complete authorised book on television (Baird Experimental) transmission and receiving is now ready; order "Television To-day and To-morrow" (Moseley and Barton Chapple), 7/6 net.—Pitman's, Parker St., Kingsway, W.C.2. [9309]

STEP by Step Wireless.—A complete course of instruction for wireless engineers; send 1/- for first 4 weeks.—Clifford Pressland, A.M.I.E.E., Hampton-on-Thames. [0195]

FREE: Inventor's Guide on Patents.—T. A. A., 253, (W), Gray's Inn Rd., London, W.C.1. [6373]

INDEX TO ADVERTISEMENTS.

Adolph, Fredk.	PAGE 11	Garnett, Whiteley & Co., Ltd.	PAGE 9	Pertrix, Ltd.	PAGE Cover iv.
Appleby, E. Hetherington	8	General Electric Co., Ltd.	1	Philips Lamps, Ltd.	Cover iii.
Baker's "Selhurst" Radio	8	German Radio Exhibition	Cover ii.	Player's	7
Belling & Lee, Ltd.	10	H. & B. Radio Co.		Potter, H. B., & Co., Ltd.	12
Benjamin Electric, Ltd.	7	Hayward, F. C., & Co.		Regent Radio Supply Co.	
Burne-Jones & Co., Ltd. (Magnum) ..	10	Holzmann, Louis, Ltd.	Cover i.	Rigby & Woolfenden	11
Celestion, Ltd.	12	Hughes, F. A., & Co., Ltd.	Cover i.	Six-Sixty Radio Co., Ltd.	
Cole, E. K., Ltd.	Cover i.	Lectro Linx, Ltd.		Stratton & Co., Ltd.	Cover ii.
Darwins, Ltd.	12	Lever, Eric J. (Trix), Ltd.		Telegraph Condenser Co.	Cover ii.
Day, Will, Ltd.		London Electric Wire Co., & Smiths, Ltd. ...	2	Thomas, Bertram	8
Eastick, J. J., & Sons		Marconiphone Co., Ltd.	6	Transformer Repair Co.	
Edison Swan Electric Co., Ltd.	5 and 7	McMichael, I., Ltd.		Varley (Oliver Pall Control), Ltd.	11
Electradix Radios	8	M-L Magneto Synd., Ltd.	Cover iii.	Westinghouse Brake & Saxby Signal Co., Ltd.	2
Ever Ready Co. (G.B.), Ltd.		Mullard Wireless Service Co., Ltd. Cover i. & p. 3		Wilkins & Wright, Ltd.	
Exact Manf. Co.	10	Parker, W. H.	11	Wingrove & Rogers, Ltd.	8
Exide Batteries		Paroussi, E.		Wright & Weaire, Ltd.	
Fonteyn & Co., Ltd.		Perseus Manf. Co., Ltd.	8		
Formo Co.					

Mention of "The Wireless World," when writing to advertisers, will ensure prompt attention.

**RECTIFYING
VALVES
TO RELY ON**



Reliable and efficient H.T. supply assured . . . output easily varied and smoothed . . . long life and high efficiency . . . in fact PHILIPS Rectifying valves. There is a Philips valve suitable for every all-electric receiver H.T. Unit, transmitter, amplifier, and wherever D.C. is required from A.C. There are over 50 types for special purposes.

Type 1821 (illustrated) is a new full wave rectifier with a max. anode voltage of 250 and an output of 60 m/A. The filament takes a current of one amp. at 4 volts. Price 17/6.

**PHILIPS
RECTIFYING VALVES**

Made by the manufacturers of the famous Philips Argenta electric lamps, commercial and industrial fittings, all-electric radio receivers, and neon signs.

PHILIPS LAMPS LTD., PHILIPS HOUSE, 145, CHARING CROSS ROAD, LONDON, W.C.2.

R.V.6.

Advertisements for "The Wireless World" are only accepted from firms we believe to be thoroughly reliable.

A

P · C

posted to-day will bring you by return particulars of how you can operate an

A · C

All-Electric Receiver from a

D · C

supply main, by using the



**D. C. to A. C.
ROTARY
TRANSFORMER**

Can be supplied to run from any voltage 12-250 V.D.C. 40 Watt model £13; 85 Watt model £19. Recommended and used by Philips Radio, Marconiophone, Burndept, Kolster-Brandes, M.P.A., etc., etc.

THE M-L MAGNETO SYND. LTD.
Radio Dept., COVENTRY.
Telephone: 5001.

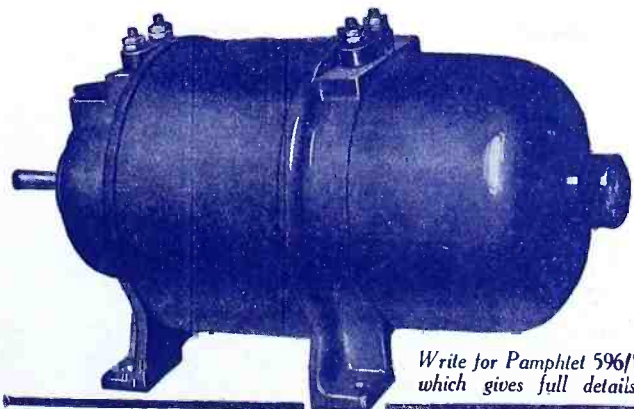

Write for Pamphlet 596/1 which gives full details

Godbolds.

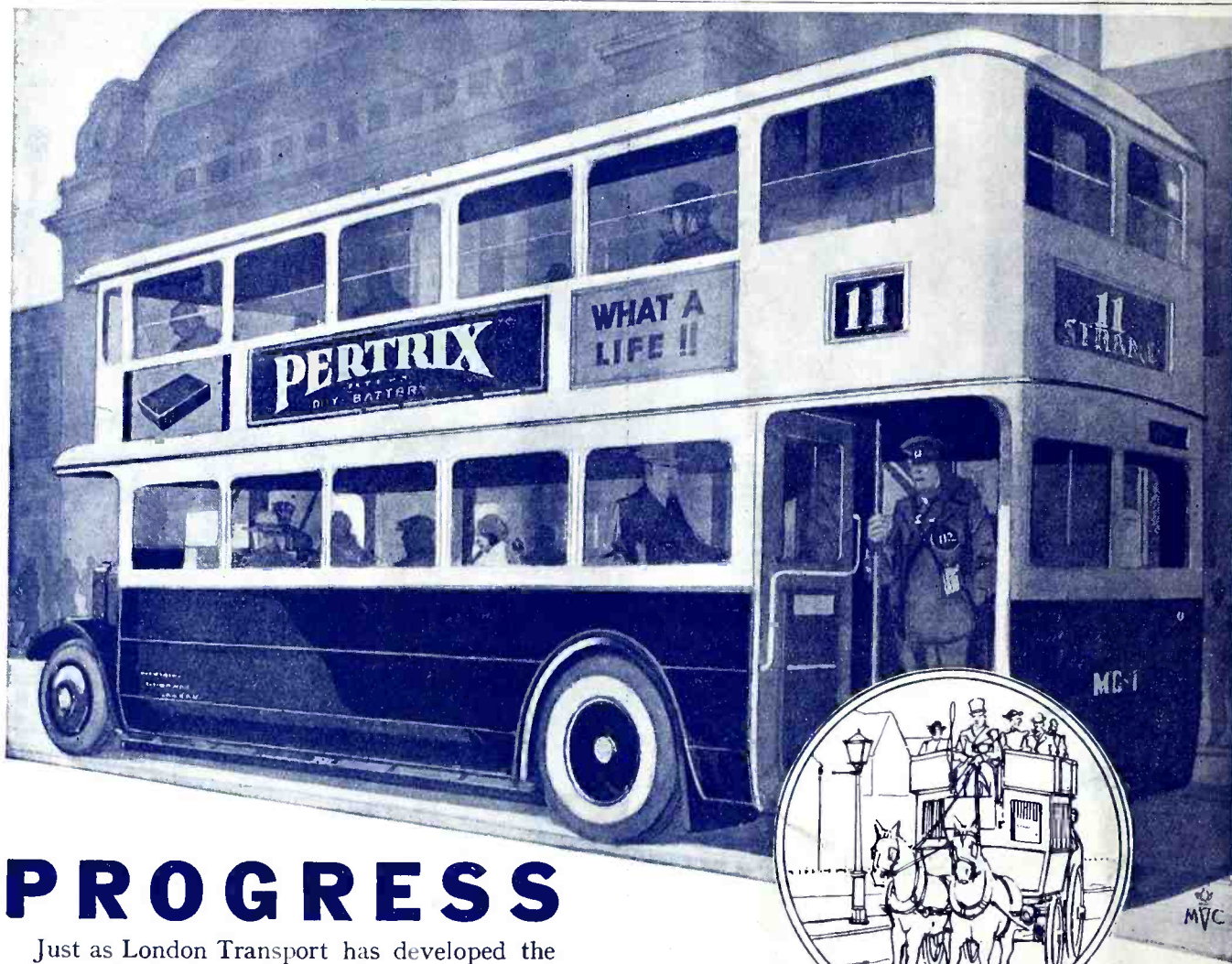

PROGRESS

Just as London Transport has developed the latest 6-wheeler "General" from the old Shillibeer, so has the growth of Radio brought with it the latest improvement in H.T. batteries—Pertrix.

Pertrix batteries employ

NO SAL-AMMONIAC

Therefore there is no internal corrosion, no sudden changes in internal resistance, no crackling, no rapid failure. Over its whole life, which is 60% greater than normal, Pertrix gives you steady reliable, H.T. supply and, therefore, exceptionally good reception.

Pertrix batteries for flash lamps are also available. Write for leaflet "B," which will give you full particulars of all types.

PRICES.									
STANDARD.		DISCHARGE 12 MILLIAMPS.				GRID BIAS.			
		Size in inches.							
Volts.	L.	B.	H.	s. d.	Volts.	s. d.			
60	5 7/8	6 1/4	3 1/8	8 0	9	1 6			
100	8 1/2	6 1/4	3 1/8	13 0	12	2 3			
120	10 1/8	6 1/4	3 1/8	15 6	15	2 9			

What a life!



60% LONGER LIFE

PERTRIX

NON SAL-AMMONIAC

DRY BATTERY

PERTRIX, LTD., Britannia House, 233, Shaftesbury Avenue, London, W.C.2

M.C. 121.